

EMERGENCY
SANITATION

EMERGENCY SANITATION

ASSESSMENT AND PROGRAMME DESIGN

Peter Harvey, Sohrab Baghri and Bob Reed



Water, Engineering and Development Centre
Loughborough University UK



Water, Engineering and Development Centre
Loughborough University
Leicestershire
LE11 3TU UK

© WEDC, Loughborough University, 2002

Any part of this publication, including the illustrations (except items taken from other publications where the authors do not hold copyright) may be copied, reproduced or adapted to meet local needs, without permission from the author/s or publisher, provided the parts reproduced are distributed free, or at cost and not for commercial ends, and the source is fully acknowledged as given below. Please send copies of any materials in which text or illustrations have been used to WEDC Publications at the address given above.

A reference copy of this publication is also available online at:
<http://www.lboro.ac.uk/wedc/publications/es.htm>

Harvey, P.A., Baghri, S. and Reed, R.A. (2002)
Emergency Sanitation: Assessment and programme design
WEDC, Loughborough University, UK.

ISBN Paperback 1 84380 005 5

This document is an output from a project funded by the UK
Department for International Development (DFID)
for the benefit of low-income countries.
The views expressed are not necessarily those of DFID.

Designed and produced at WEDC

About the authors

Peter Harvey is a Research Associate at the Water, Engineering and Development Centre (WEDC). He has worked as a public health engineer on emergency water supply and sanitation (watsan) programmes in Africa, Asia and Eastern Europe. He also has experience of rural water supply and sanitation projects in low-income countries. His major interests include groundwater development and the sustainability of water and sanitation projects.

Sohrab Baghri is a civil engineer with over fifteen years experience of water supply and sanitation projects in Africa, Asia and the Middle East. He has worked on both emergency and long-term development programmes with a wide range of international aid agencies. His interests include water treatment, environmental sanitation and watsan facilities for children and disabled people. He is now Water and Sanitation Adviser at Plan International's headquarters.

Bob Reed is a Senior Programme Manager at WEDC. He specialises in water supply and sanitation for rural areas, low-income urban communities and refugees. He has considerable experience of training, design and project implementation in the Pacific, the Caribbean, Asia and Africa. In recent years he has focused on the provision of improved and sustainable water supply and sanitation systems for displaced populations.

The authors would like to hear from anyone who uses this book in the field with comments on its usefulness and areas which require improvement. Please forward comments or suggestions to Bob Reed at the address overleaf.



Peter Harvey



Sohrab Baghri



Bob Reed

About WEDC

The Water, Engineering and Development Centre (WEDC) is concerned with education, training, research and consultancy for improved planning provision and management of physical infrastructure and services for development in low- and middle-income countries, focusing on the needs and demands of the poor.

WEDC is devoted to activities that improve the health and well-being of people living in both rural areas and urban communities. We encourage the integration of technological, environmental, social, economic and management inputs for effective and sustainable development.



Water, Engineering and Development Centre
Loughborough University
Leicestershire
LE11 3TU UK

Phone: +44 1509 222885
Fax: +44 1509 211079
Email: WEDC@lboro.ac.uk
<http://www.lboro.ac.uk/wedc/>

Collaborators

The ‘Assessment and Programme Design for Emergency Sanitation’ project (R6873) has been funded by the Department for International Development (DFID) of the British Government.

The following organisations have acted as peer reviewers for this research contract. They have reviewed draft documents, provided access to staff for interview, given advice on project design and implementation, provided information, and have been involved in and provided support for field trials. This project would not have been possible without their support and encouragement.

Opinions noted within these documents do not necessarily represent those of DFID or the collaborators, but are solely those of the authors.

DROP

Development through Resource
Organisation and Planning



INTERNATIONAL COMMITTEE OF THE RED CROSS



International Federation
of Red Cross and Red Crescent Societies



UNHCR



UNITED NATIONS HIGH COMMISSIONER FOR REFUGEES

Acknowledgements

Thanks go to all individuals and organisations that have been involved in the production of the manual, guidelines and training modules. It is hoped that the wide range of organisations and individuals that have contributed to this project will facilitate the usefulness of this work to an even wider range of personnel and emergency situations.

All contributions are gratefully acknowledged. It should be noted, however, that the opinions in this document are solely those of the authors. The following individuals have contributed to the research either as peer reviewers, advisory panel members, by testing the work in the field, or by providing information for specific sections of the work.

Peer reviewers

DFID	Department for International Development, UK
John Adams	Bioforce/Trinome, France
Ben Fawcett	IIDS, Southampton, UK
Joy Morgan	Independent Consultant, UK
Rutger Verkerk	MSF, Amsterdam, Holland

Advisory panel members

Astier Almedom	ex-LSHTM, London, UK
Andy Bastable	OXFAM, Oxford, UK
Murray Biedler	MSF, Brussels, Belgium
Dixon Chanda	ex-MSF, Amsterdam, Holland
Riccardo Conti	ICRC, Geneva, Switzerland
Ulrich Jaspers	IFRC, Geneva, Switzerland
Ajeet Oak	DROP, Pune, India
Claude Rakotomalala	UNHCR, Geneva, Switzerland
Rutger Verkerk	MSF, Amsterdam, Holland

Editorial contributions

Kimberley Clarke Independent Consultant, UK

Other contributors

Raissa Azzalini	MSF, Burundi
William Corkill	IFRC, Nairobi, Kenya
Jean-Michel Detre	MSF, Burundi
SHEMELES Gebeyehu	MSF, Kala, Zambia
Julius Kibassa	TRCS, Lugufu, Tanzania
Peter Maes	MSF, Brussels, Belgium
Radjabu Mavlidi	MSF, Burundi
Qumrun Nahar	UNICEF, Bangladesh
Joseph Ng'ambi	MSF, Kala, Zambia
Deo Ntahonsigaye	MSF, Burundi
Gorik Ooms	MSF, Burundi
Samuel Phiri	MSF, Kala, Zambia
Veronique Ridel	MSF, Burundi
Hans Van Dillen	MSF, Lusaka, Zambia
Alberto Villani	MSF, Burundi

Overview

Contents

1-14: Emergency sanitation manual

15-20: Guidelines for assessment and design

Case study

Bibliography

Index

Contents

Abbreviations	xviii
Glossary of terms	xix
List of figures	xx
List of tables	xxii

MANUAL

Chapter 1. Introduction	1
1.1 About this book	1
1.2 What is emergency sanitation?	2
1.3 Approach to sanitation programmes	3
1.4 People	5
Chapter 2. Is intervention necessary?	7
2.1 Criteria for intervention	7
2.2 Population and health	8
2.3 Assessing the need for intervention	11
Chapter 3. Principles of assessment	13
3.1 Assessment steps	13
3.2 Who should be involved in assessments?	15
3.3 Data collection	15
3.4 Equipment	16
3.5 Background information	16
3.6 Observation (visual assessment)	17
3.7 Mapping	17
3.8 Surveys	18
3.9 Interviewing	18
3.10 Group discussion (focus groups)	19
3.11 Measuring	19
3.12 Counting and calculating	19
3.13 Assessment reports	20
Chapter 4. Background information	21
4.1 General information	21
4.2 Demographic data	22
4.3 Physical features	24
4.4 Other organisations	29

Chapter 5. Recommended minimum objectives	31
5.1 Minimum objectives	31
5.2 Excreta disposal	32
5.3 Solid waste management	36
5.4 Waste management at medical centres	40
5.5 Disposal of dead bodies	44
5.6 Wastewater management	48
5.7 Hygiene promotion	52
Chapter 6. Excreta disposal	57
6.1 Associated risks	57
6.2 Selection criteria for excreta disposal	58
6.3 Communal or family latrines?	62
6.4 Immediate measures	63
6.5 Technology choice: Longer term intervention	68
6.6 Strategies for difficult conditions	78
6.7 Intervention levels	86
6.8 Design and construction	88
6.9 Emptying pits	101
Chapter 7. Solid waste management	105
7.1 Associated risks	105
7.2 Sources and types of solid waste	106
7.3 Initial steps	109
7.4 Key components of solid waste management	110
7.5 On-site disposal options	111
7.6 Transportation options	114
7.7 Off-site disposal options	116
7.8 Intervention levels	118
7.9 Protective measures	119
Chapter 8. Waste management at medical centres	121
8.1 Types and sources of medical waste	121
8.2 Associated risks	122
8.3 Minimising risks	124
8.4 Segregation, storage and transportation	125
8.5 Disposal technology choices	127
8.6 Intervention levels	131
8.7 Education and training	132
8.8 Key recommendations for waste management	133

Chapter 9. Disposal of dead bodies	135
9.1 Associated risks: myths and realities	135
9.2 Medical epidemics	136
9.3 Cultural practices and needs	138
9.4 Mortuary service and handling of the dead	138
9.5 Burial	139
9.6 Cremation	140
9.7 Key recommendations for the disposal of the dead	140
Chapter 10. Wastewater management	143
10.1 Associated risks	143
10.2 Sources and types of wastewater	144
10.3 Selection criteria	144
10.4 Technology choice	146
10.5 Wastewater treatment	155
10.6 Cholera treatment centres	161
10.7 Rainfall runoff	161
Chapter 11. Hygiene promotion	163
11.1 Hygiene and health	163
11.2 Definition of hygiene promotion	164
11.3 Focus of hygiene promotion in emergencies	164
11.4 Key principles of hygiene behaviour	165
11.5 Staff	167
11.6 Women, men and children	168
11.7 Hygiene promotion actions	169
11.8 Intervention levels	172
11.9 Key indicators for hygiene practice	173
11.10 Key indicators for programme implementation	174
11.11 Relationship with other aspects of sanitation	174
Chapter 12. Community participation	177
12.1 What is meant by community participation?	177
12.2 Stakeholder analysis	179
12.3 Gender and vulnerable groups	181
12.4 Participation matrix	181
12.5 Community mobilisation	182
12.6 Participatory appraisal techniques	183
12.7 Problem-tree analysis	185
12.8 Finance	187

Chapter 13. Programme design	189
13.1 Programme summary	189
13.2 The Logical Framework	190
13.3 Activity plan	192
13.4 Programme Gantt chart	193
13.5 Personnel	194
13.6 Implementation plan	195
13.7 Costs and budget	195
13.8 Proposal writing	198

Chapter 14. Implementation	199
14.1 Implementation framework	199
14.2 Staff	199
14.3 Materials and equipment	200
14.4 Finances	201
14.5 Time	202
14.6 Outputs	202
14.7 Community	203
14.8 Information	203
14.9 Programme management	204
14.10 Monitoring and evaluation	206
14.11 Monitoring methods	207
14.12 Evaluation	211
14.13 Report writing	213

GUIDELINES

Chapter 15. Instructions for use	217
15.1 About these Guidelines	217
15.2 Approach	218
15.3 Guideline user group	219
15.4 Relationship between emergency sanitation and other activities	220
15.5 Time targets	220
15.6 Instructions for use	220

Chapter 16. Rapid assessment and priority setting	223
16.1 Is intervention appropriate?	223
16.2 Assessment process	223
16.3 Getting started	225
16.4 Data collection	225
16.5 Data analysis	234
16.6 Interpretation of results	250

Chapter 17. Outline programme design	257
17.1 Design process	257
17.2 Problems, constraints and points of interest	259
17.3 Solution selection	259
17.4 Comparison with current practice	259
17.5 Outline programme proposal	260
17.6 Approval of programme and budget	260
Chapter 18. Immediate action	263
18.1 Objective of immediate action	263
18.2 Action selection process	263
18.3 Relationship with longer-term activities	265
Chapter 19. Detailed programme design	267
19.1 Design process	267
19.2 Stakeholder analysis	268
19.3 Gender and vulnerable groups	269
19.4 Community participation	269
19.5 Baseline survey	270
19.6 Necessary action selection	272
19.7 Selection checklist	276
19.8 Developing the logical framework	277
19.9 Developing the programme activity plan	277
19.10 Developing the time frame for the activity plan	277
19.11 Determining responsibilities	278
19.12 Determining resources	279
19.13 Preparing the budget	280
19.14 Feedback and refinement of plan of action	280
19.15 Final programme proposal and approval	281
Chapter 20. Implementation	283
20.1 What is implementation?	283
20.2 Implementation planning	284
20.3 Implementation framework	286
20.4 Implementation management	288
20.5 Monitoring	289
20.6 Evaluation	290
CASE STUDY	
Case study: Kala Camp, Luapula, Zambia	293
Bibliography	349
Index	353

Abbreviations

CDC	Centres for Disease Control
DFID	Department for International Development (UK)
DROP	Development for Resource Organisation and Planning
ICRC	International Committee of the Red Cross
IFRC	International Federation of Red Cross and Red Crescent Societies
LSHTM	London School of Hygiene and Tropical Medicine
M&E	Monitoring and evaluation
MSF	Médecins Sans Frontières
NGO	Non-governmental organisation
O&M	Operation and maintenance
PAHO	Pan American Health Organisation
PHAST	Participatory Hygiene and Sanitation Transformation
PRA	Participatory rural appraisal
RRA	Rapid rural appraisal
SWOT	Strengths, weaknesses, opportunities, threats
TRCS	Tanzania Red Cross Society
TSS	Total suspended solids
UNCHS	United Nations Centre for Human Settlements (Habitat)
UNHCR	United Nations High Commissioner for Refugees
UNICEF	United Nations Children's Fund
uPVC	unplasticised polyvinyl chloride
VIP	Ventilated improved pit (latrine)
WEDC	Water, Engineering and Development Centre
WHO	World Health Organisation

Glossary of terms

Desludge:	to empty the contents of a latrine pit or septic tank
Closed setting:	affected site has clear boundaries and population figures are known (e.g. refugee camp)
Epidemic:	the appearance of a particular disease in a large number of people in the same period of time
Faecal–oral:	disease transmission from faeces to the human digestive system via the mouth
Gender:	the physical and/or social condition of being male or female
Infiltration:	the absorption of liquid by material, for example when water is absorbed by the ground
Landfilling:	the disposal of solid waste by excavating a hole in the ground, filling this with waste and then covering with soil to fill the hole
Latrine:	a toilet, especially a simple one such as a hole in the ground
Logistics:	the careful organisation of procurement, transportation, storage and distribution of materials and equipment
Morbidity:	the number of cases of a particular disease reported within a particular society and within a particular period of time
Mortality:	the number of deaths within a particular society and within a particular period of time
Open defecation:	to defecate outside a latrine, normally in a natural environment
Open setting:	affected site has no clear boundaries such as a normal urban or rural area
Sludge accumulation:	the build up in volume of excreta, normally within a latrine pit or septic tank
Socio-cultural:	relating to the social and cultural practices, beliefs and traditions within a particular society
Stakeholder:	a person or group of people who have a share or a personal or financial involvement in a programme
Superstructure:	the part of a building which is above the ground
Sustainability:	the ability of something (e.g. activity, facility or system) to keep operating effectively without negative impact
Vector:	an insect or animal which carries a disease from one animal or plant to another (particularly humans)
Wastewater:	‘dirty’ water arising from laundry areas, kitchens, bathrooms, etc.

List of figures

1.1:	Approach to emergency sanitation programmes	4
2.1:	Causes and transmission routes of environmental-related diseases	9
3.1:	Assessment steps	14
4.1:	Sketch map of the affected area	25
4.2:	Sketch map of dwelling area	26
6.1:	Transmission of disease from faeces	58
6.2:	Open defecation field	64
6.3:	Trench defecation field	65
6.4:	Shallow family latrine	66
6.5:	A simple pit latrine	68
6.6:	Deep trench latrines	69
6.7:	Ventilated improved pit latrine	71
6.8:	Cross-section of a typical water-seal pan	72
6.9:	Pour-flush latrines	72
6.10:	Overhung latrine	73
6.11:	Borehole latrine	75
6.12:	Temporary toilet block over existing sewer	77
6.13:	Pollution from a pit latrine above the water table	78
6.14:	Raised twin-pit ventilated latrine	80
6.15:	Sand-enveloped pit	80
6.16:	Double vault composting latrine	82
6.17:	Wastewater treatment using a septic tank	83
6.18:	Aqua privy	85
6.19:	Cross-section of latrine slab with footrests	90
6.20:	Reinforced latrine slab	91
6.21:	Domed pit slab	92
6.22:	Wood and mud latrine slab	92
6.23:	Squat-hole cover	94
6.24:	Stress concentrations on rectangular and circular pits	95
6.25:	Shallow pit with lining	97
6.26:	Vacuum tanker emptying latrine pit	101
6.27:	Vacuum tanker with remote pumping unit	102

7.1:	Initial steps in solid waste management	109
7.2:	Communal solid waste pit	112
7.3:	Communal bin made from an old oil drum	113
7.4:	Refuse collection containers and vehicles	115
7.5:	Emptying a cart at a transfer station	116
7.6:	Simple landfilling	117
8.1:	Categories of waste from medical centres	122
8.2:	Sharps container	126
8.3:	Temporary drum incinerator	128
8.4:	Permanent incinerator	129
8.5:	Sharps pit	130
10.1:	Wastewater treatment by soil	147
10.2:	Unlined soakpit	148
10.3:	Soakpit lined	149
10.4:	Section through an infiltration trench	151
10.5:	Evaporation pan	153
10.6:	Evapotranspiration bed	154
10.7:	Grease trap	156
10.8:	Settlement tank	157
10.9:	Tank inlet and outlet pipe	158
10.10:	Horizontal reed bed	159
10.11:	Vertical reed bed	160
12.1:	Problem-tree analysis example	186
12.2:	Objectives-tree analysis example	187
15.1:	Stages in emergency sanitation programme design	218
16.1:	Assessment process	224
16.2:	Priority-setting flow chart	253
17.1:	Outline design process	258
18.1:	Immediate action process	264
19.1:	Detailed design process	268
20.1:	Implementation planning process	284

List of tables

2.1:	Sanitation-related diseases, causes and transmission routes	8
2.2:	Approximate threshold levels for mortality	11
3.1:	Assessment equipment	16
4.1:	Assessment cover page	22
4.2:	Demographic profile	23
4.3:	Soil infiltration rates	27
5.1:	Recommended minimum objectives for safe excreta disposal	32
5.2:	Recommended minimum objectives for solid waste management	36
5.3:	Recommended minimum objectives for waste management at medical centres	40
5.4:	Recommended minimum objectives for the disposal of dead bodies	44
5.5:	Recommended minimum objectives for wastewater management	48
5.6:	Recommended minimum objectives for hygiene promotion	52
6.1:	Advantages and disadvantages of communal and family latrines	62
6.2:	Recommended interventions for space of more than 30m ² per person	86
6.3:	Recommended interventions for space of 20-30m ² per person	87
6.4:	Recommended interventions for space of less than 20m ² per person	87
6.5:	Spacing for steel reinforcing bars in pit latrine slabs	91
6.6:	Lining requirements for different soil types	96
6.7:	Suggested maximum sludge accumulation rates	98
6.8:	Recommended septic tank retention times	99
6.9:	Value of sludge digestion factor 'F'	100
7.1:	Recommended interventions for different scenarios	119
8.1:	Risks, pathways and hazards of medical waste	123
8.2:	Segregation categories	125
8.3:	Recommended interventions for different scenarios	132
10.1:	Sizes of settlement tanks	143
11.1:	The effects of hygiene practice on diarrhoeal disease	164
11.2:	Focus group discussion agenda	170
11.3:	Recommended interventions for different scenarios	172

12.1:	Example stakeholder analysis	180
12.2:	Example participation matrix	182
12.3:	Example ranking exercise	184
12.4:	Example seasonal chart for health and hygiene	185
13.1:	Generalised logical framework	190
13.2:	Example activity plan	192
13.3:	Example Gantt chart	193
13.4:	Example human resource plan	194
13.5:	Example implementation plan	195
13.6:	Example sanitation budget	196
14.1:	Implementation by milestones	205
14.2:	Monitoring framework	208
14.3:	Log-frame analysis example	209
14.4:	Checklist analysis table	211
14.5:	Evaluation framework	212
14.6:	Situation report example	214
14.7:	Evaluation report outline	215
16.1:	Base score definitions	235
16.2:	Sector analysis results	251
16.3:	Assessment summary	252
16.4:	Intervention levels	252
16.5:	Recommended intervention levels and scenarios	254
17.1:	Structure of outline programme proposal	260
19.1:	Stakeholder analysis	269
19.2:	Excreta disposal options	273
19.3:	Solid waste management options	273
19.4:	Waste management options at medical centres	274
19.5:	Disposal options for dead bodies	274
19.6:	Wastewater management options	275
19.7:	Hygiene promotion options	275
19.8:	Selection checklist	276
19.9:	Logical framework	277
19.10:	Example Gantt chart	278
19.11:	Implementation plan	279
20.1:	Implementation framework	287
20.2:	Implementation by milestones	288

Chapter 1

Introduction

1.1 About this book

This book has been written to help all those involved in planning and implementing emergency sanitation programmes. Users may include field technicians, engineers and hygiene promoters, as well as technical and non-technical staff at agency headquarters.

The authors have attempted to provide a balance between the hardware (technical) and software (socio-cultural, institutional) aspects of sanitation programmes. It is hoped that this may help technical staff to understand better the software aspects, and hygiene and community health specialists to understand better the more technical aspects.

The main focus of the book is a systematic and structured approach to assessment and programme design. There is a strong emphasis on socio-cultural issues and community participation throughout.

1.1.1 Structure of this book

This book is divided into three main sections:

- Manual
- Guidelines
- Case study

The Manual is designed to act as a textbook which can be referred to for information regarding minimum objectives, technical options, planning and implementation. Sectoral chapters do not aim to cover each topic fully but to provide key relevant information for quick reference. There is a list of further reading material given at the end of each chapter and a full Bibliography at the end of the book.

The Guidelines are intended for use in the field to conduct rapid assessments, prioritise needs and design effective relief programmes. Reference is made to the Manual where supporting information may be required.

In addition, there is a Case Study at the end of the book which demonstrates how the Guidelines can be applied in the field.

EMERGENCY SANITATION

The book is accompanied by an Aide Memoire to Assessment and Design, which is a summary of the Guidelines process, outlining the key issues and procedures. An electronic version of the book is available on CD.

1.1.2 How and when to use this book

This book is not designed to be read from beginning to end. The Manual may be used as a reference text and hence can be 'dipped into' at any point. The Guidelines, however, have been developed as a complete process and each Chapter represents a specific activity in assessment and design.

The material in the book has been designed so as to be applicable to sanitation programmes responding to a wide range of emergency situations including conflict-induced disasters, famine, floods, earthquakes and cyclones/hurricanes. It should also be suitable for closed settings, such as large refugee camps, as well as open settings, such as where displaced people live within a local community and situations where the affected population remains in a disaster-affected area.

The Manual and Guidelines may be applied to emergency sanitation programmes that last a few months or several years (see emergency phases below).

1.2 What is emergency sanitation?

Perceptions of what constitutes an 'emergency' vary between personnel and between organisations. Generally, an emergency may be considered to be the result of a man-made and/or natural disaster, whereby there is a serious, often sudden, threat to the health of the affected community which has great difficulty in coping without external assistance.

1.2.1 Stages of an emergency

An emergency may last a few weeks, several months or years. There are several ways in which emergencies may be divided into distinct phases (Davis and Lambert, 1996; UNHCR, 2000, etc.). For the purposes of this book an emergency sanitation programme is considered to consist of three distinct stages:

- Immediate
- Short term
- Long term

The immediate (emergency) phase is the initial stage of a sanitation programme and occurs immediately after the impact phase of a disaster; this is typified by great instability and often high mortality. The programme aim is generally to contain and localise sources of sanitation-related disease in order to create a safer environment and minimise the spread of disease. This phase typically lasts one or two months.

INTRODUCTION

The short-term phase is the period of stabilisation following the immediate phase when the programme aim is to reduce morbidity and mortality rates (where appropriate) and prevent any further spread of disease. This phase typically lasts up to six months.

The long-term phase encompasses recovery (or a return to ‘normality’) and settlement where members of the affected population return to their homes or settle in a new area. During this phase the primary aim of a sanitation programme is likely to be to sustain the health and well-being of the affected population, and promote self-sufficiency. This phase may last up to several years.

1.2.2 What is sanitation?

The term ‘sanitation’ is often used and understood by people to refer only to excreta and wastewater disposal. A WHO Study Group in 1986 defined sanitation as ‘the means of collecting and disposing of excreta and community liquid wastes in a hygienic way so as not to endanger the health of individuals and the community as a whole’ (WHO, 1987).

In recent years, however, there has been a growing tendency amongst aid agencies to use the term ‘sanitation’ to refer to environmental conditions that affect the health of the affected community. This is often encompassed in the term ‘environmental sanitation’.

For the purposes of this book, ‘emergency sanitation’ is considered to include the following areas of intervention:

- Excreta disposal
- Solid waste management
- Waste management at medical centres
- Disposal of dead bodies
- Wastewater management
- Hygiene promotion

These sectors are described in detail in Chapters 6-11 of the Manual.

The following definition can be used for emergency sanitation intervention:

Emergency sanitation intervention is the means of controlling and managing excreta, solid waste, medical waste, dead bodies, and wastewater, and of promoting best hygiene practice in order to create a safer environment and minimise the spread of disease in a disaster-affected area.

1.3 Approach to sanitation programmes

The approach to emergency sanitation programmes that this book promotes is illustrated in Figure 1.1.

EMERGENCY SANITATION

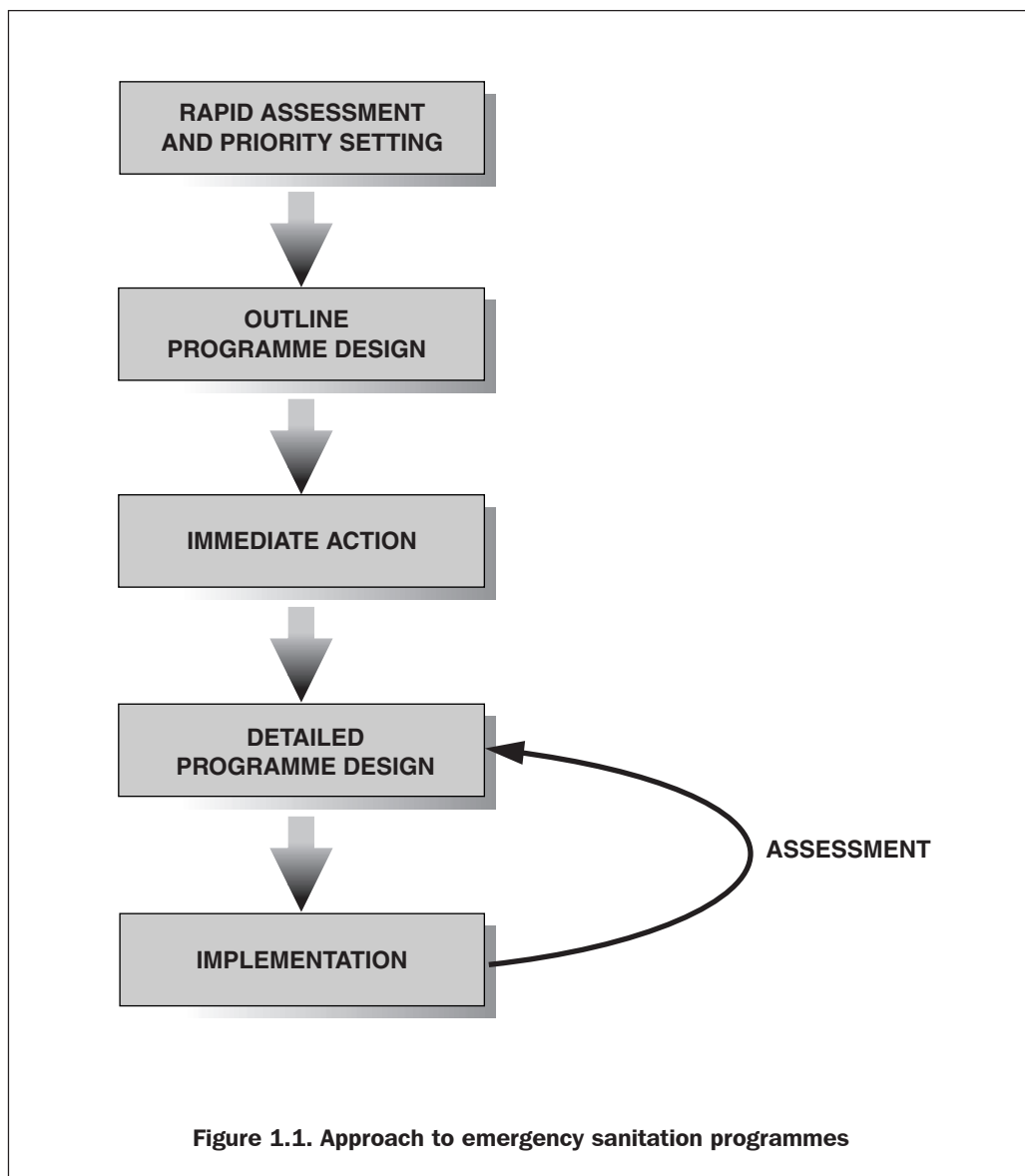

The implementation stage includes monitoring and evaluation (M&E). In the long term this process can evolve into the traditional development Project Cycle of assessment, planning (programme design), implementation and M&E.

The Guidelines are designed to guide the reader through this process to facilitate effective disaster response programmes. The Manual contains supporting information to assist the Guidelines process as well as chapters on specific sanitation sectors.

1.4 People

All humanitarian relief programmes should be designed to meet the needs of people who require assistance and who find themselves in an extraordinary situation in which their lives have been severely disrupted. For the purposes of this book these people are collectively referred to as the 'affected' community or population. This may include displaced people, settled people and people living in areas to which displaced people have moved.

1.4.1 Community participation

Community participation refers to members of the affected population being actively involved in analysing their own problems and needs and those of their community, making decisions affecting their lives, and implementing appropriate intervention programmes. Chapter 12 looks at community participation in more detail but it should be considered in all sections of this book.

1.4.2 Gender and vulnerability

It is essential that any emergency humanitarian programme aims to reach people of both genders and the most vulnerable people within the affected population. In many emergency situations in which people have been displaced unaccompanied women make up the vast majority of the adult population; in other situations there may be large numbers of children or disabled people. Specific attention is given to the differing needs of men, women and children throughout this book, as well as to the needs of the sick, disabled and elderly.

References and further reading

- Adams, John (1999) *Managing Water Supply and Sanitation in Emergencies*. Oxfam: Oxford.
- Davis, Jan and Lambert, Robert (1996) *Engineering in Emergencies: A practical guide for relief workers*. RedR / IT Publications: London.
- Médecins Sans Frontières (1994) *Public Health Engineering in Emergency Situation*. Médecins Sans Frontières: Paris.
- WHO (1987) *Technology for Water Supply and Sanitation in Developing Countries: A report of a WHO Study Group*. (WHO Technical Report Series, No.749) WHO, Geneva.

Chapter 2

Is intervention necessary?

The first questions that humanitarian agencies should ask themselves are ‘Under what conditions is emergency sanitation intervention necessary?’ and ‘Should we intervene in this particular situation?’.

2.1 Criteria for intervention

There are several factors which are likely to influence where and when an agency decides to intervene. These include the:

- capacity of the affected population;
- political situation;
- security situation;
- access to area;
- current health of the affected population; and
- potential health risks to the population.

The vast majority of emergencies worldwide receive no external assistance and are dealt with by the affected population themselves. In general, where there is existing capacity to do this, external agencies should not interfere. In some cases, however, there is limited capacity among the population and a great need for external assistance.

Assuming external assistance is required, the political context will have a major influence on where agencies are able work or decide to intervene. In general, it is impossible to operate in an area in which the government does not welcome, or at least tolerate, the presence of aid agencies.

Security and access are also important factors, as agencies are responsible for the safety and well-being of their own staff as well as those they are trying to assist. Insecure conflict-affected areas may be too dangerous to work in, or access to these areas may be extremely hazardous or even impossible.

Where these factors are not major constraints, the over-riding factor to be considered for an emergency sanitation programme is health. The purpose of any emergency sanitation pro-

EMERGENCY SANITATION

gramme should be to sustain or improve the overall health status and well-being of the affected population. Many diseases that occur after disasters are linked to poor sanitation and hygiene practice, so it is essential that sanitation is given as much priority as ‘traditional’ humanitarian interventions such as healthcare, food provision and water supply.

2.2 Population and health

2.2.1 Links between disease and sanitation

Not all diseases that occur during emergencies are directly sanitation-related. Common causes of death in young refugee children are malaria, diarrhoea, pneumonia and malnutrition. Whilst diarrhoea and malaria can be sanitation-related, generally pneumonia and malnutrition are not. However, although malnutrition is not directly sanitation-related, it is often related to persistent and repeated diarrhoeal infection. It should also be noted that the affect of diarrhoea on severely malnourished children is normally more severe than on healthy children, and may be fatal. The importance of sanitation and hygiene is therefore far-reaching.

The diseases in Table 2.1 are considered to be directly sanitation-related. It should be noted that this is **not** an exhaustive list of sanitation-related diseases and does not include illnesses directly related to water supply.

Table 2.1. Sanitation-related diseases, causes and transmission routes	
Disease	Causes and transmission routes
Faecal-oral diseases Diarrhoea Roundworm Bacillary dysentery (shigellosis) Hepatitis	Contact with faeces Lack of handwashing after defecation and before food preparation Flies
Skin and eye infections Scabies and other skin diseases Eye infections	Mites Poor personal hygiene
Soil-based diseases Hookworm	Indiscriminate defecation Walking in bare feet
Rodent-related diseases Typhus Plague	Rodents attracted by solid waste Fleas, lice, mites
Water-related diseases Malaria Dengue fever	Mosquitoes Inadequate drainage / solid waste disposal Stagnant wastewater

IS INTERVENTION NECESSARY?

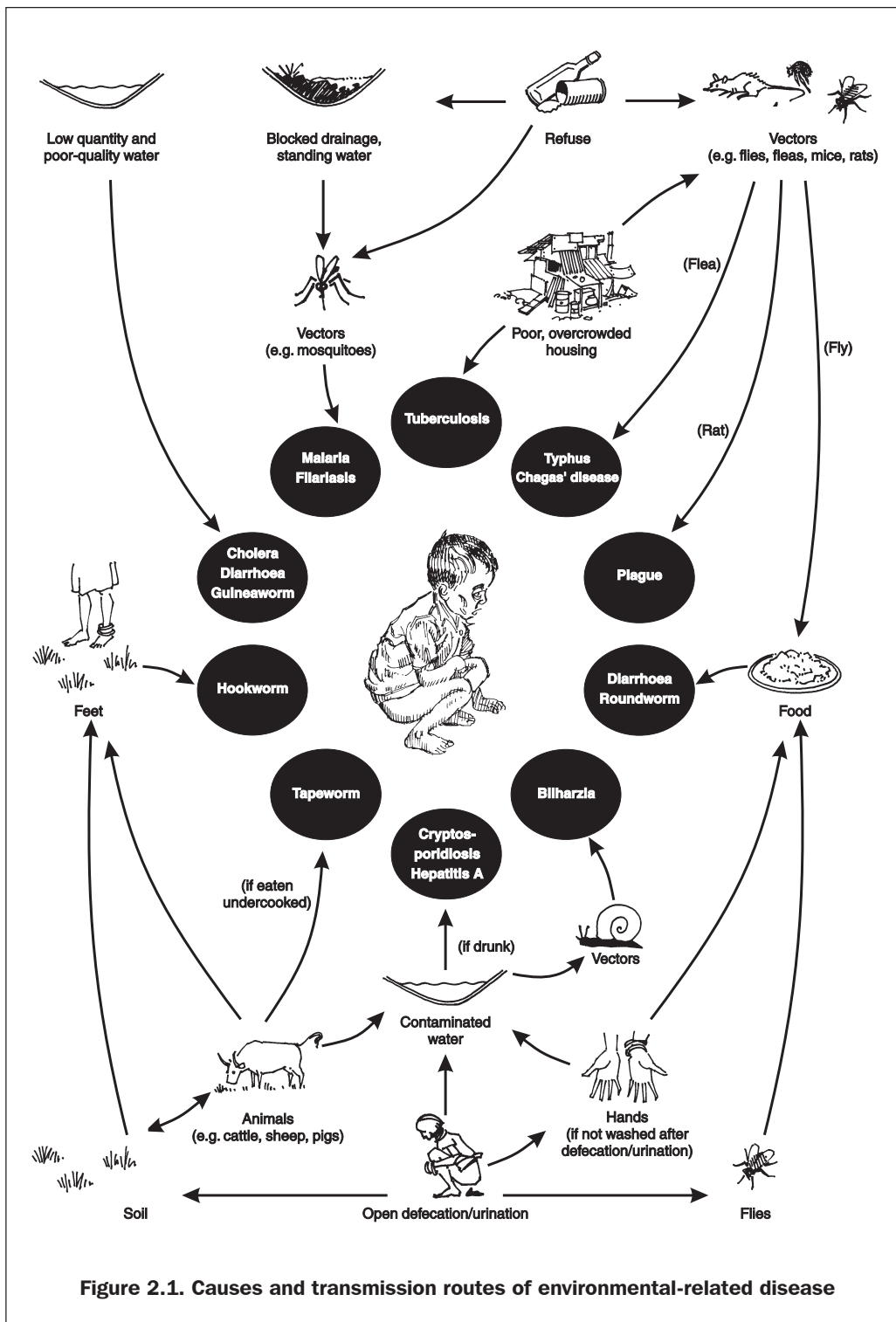

Figure 2.1. Causes and transmission routes of environmental-related disease

EMERGENCY SANITATION

In addition, contaminated medical waste can transmit highly infectious diseases such as HIV and Hepatitis.

Figure 2.1 illustrates the causes and transmission routes of environmental-related disease. It is essential that a public health approach is adopted from the onset of any emergency sanitation programme. Intervention should be a priority wherever there is a considerable threat to the health of the affected population.

2.2.2 Collaboration with medical staff

It is important that sanitation programme staff consult with qualified medical staff in the area to gather health data and interpret these in relation to local conditions.

Morbidity and mortality rates are measured in cases per 10,000 people per day. Pre-emergency values may be very difficult to determine but may be estimated through interviewing and the collection of any existing health records. The following health data will be useful (if available):

Health data

Measured in *cases per 10,000 population per day*

1. What **are** the major sanitation-related diseases among the affected population?
2. What **were** the major diseases among the affected population before this emergency?
3. What **is** the **crude mortality rate (CMR)**?
4. What **was** the **CMR**?
5. What are the major diseases among the **local** population?

Any morbidity figures recorded must be interpreted in relation to local conditions and local medical advice should be sought where possible. Morbidity data are usually interpreted as a trend and then described as epidemic (a high incidence of an uncommon disease in the area) or endemic (a disease that regularly occurs in the area).

By assessing the incidence of various diseases (morbidity rate) during the initial stages, it can be determined if intervention is appropriate and any improvement or worsening in public health can then be assessed and monitored. Great care must be taken in the interpretation of health data, however, since it is very difficult to determine **which external variables** are responsible for any apparent change in health, and these may not be directly linked to sanitation. Information on morbidity and mortality — including seasonal and spatial trends — should be collated from local health centres or hospitals where possible.

The diseases prevalent among the local population must be considered in addition to those of the displaced populations. If there is a high incidence of cases of a particular disease, reasons

IS INTERVENTION NECESSARY?

for this should be sought within the local environment. Morbidity and mortality rates can also be determined for different demographic groups within the total affected population in order to identify those most at risk.

2.2.3 Calculating morbidity and mortality rates

Both morbidity and mortality rates are expressed here in *cases per 10,000 population per day*. This can be calculated as follows:

$$\text{Morbidity/mortality rate} = \frac{\text{total number of cases among population} \times 10,000}{\text{total population} \times \text{number of days in record period}}$$

Example: There were 834 cases of malaria for a population of 56,000 in a one month period:

$$\text{Malaria morbidity rate} = \frac{834 \times 10,000}{56,000 \times 30} = 4.9 \text{ cases/10,000/day}$$

All such figures should be discussed with medical staff to determine their acceptability in the current situation.

2.3 Assessing the need for intervention

Intervention may be deemed to be necessary if:

- the incidence of disease is unacceptably high;
- the **risk** of disease is unacceptably high; or
- the crude mortality rate is unacceptably high.

The crude mortality rate can be viewed in relation to the threshold levels provided below.

Table 2.2. Approximate threshold levels for mortality (adapted from Hakewill and Moren, 1991)

<i>Situation</i>	<i>Crude mortality rate/10,000/day</i>	<i>Intervention level</i>
Stable and under control	<1	Short-term minimum objective
Serious situation	1-2	Immediate minimum objective
Emergency / Out of control	2-5	Unacceptable
Major catastrophe	>5	Very unacceptable

2.3.1 Threshold levels

Table 2.2 indicates the threshold levels for crude mortality rate at various stages of an emergency. These can be related to the recommended minimum objectives (immediate, short-term and long-term) for sanitation sectors described in Chapter 5. It is proposed that by the end of the short-term intervention period a stable and controlled situation will have been achieved. The crude mortality rate can be used as an indicator of the need for sanitary intervention, this is however only an **indicator**. If long-term objectives appear to be in place this should not permit complacency; on-going actions should be undertaken to anticipate and prevent any degeneration in public health.

Attempts have been made to set similar threshold levels for morbidity rates but this has proved very difficult since morbidity figures must be viewed in relation to what is normal in that situation or area.

Where health data are unavailable the decision as to whether to intervene or not must be based solely on the **risk** of disease. This requires a rapid assessment of the affected area (Chapter 16).

References and further reading

- Hakewill, P.A. and Moren, A. (1991) Monitoring and Evaluation of Relief Programmes *Tropical Doctor*, Supplement 1, pp 24-28.
- Médecins Sans Frontières (1997) *Refugee Health: An approach to emergency situations*. Médecins Sans Frontières, Macmillan Education Ltd.; London and Basingstoke.

Chapter 3

Principles of assessment

This section is designed to describe the methods that can be used in the rapid assessment process. It does not cover the interactive consultation and community participation methods that are described in Chapter 12.

3.1 Assessment steps

The term ‘assessment’ is often used, but what does it really mean? In assessing the sanitation needs of an affected population it is first necessary to identify the key sanitation problems and then to identify the needs arising as a result of these problems. Once these needs have been identified they can then be evaluated in order to determine which needs are greatest, or which needs should be given priority concerning intervention. This can be expressed in the following flow chart (Figure 3.1):

EMERGENCY SANITATION

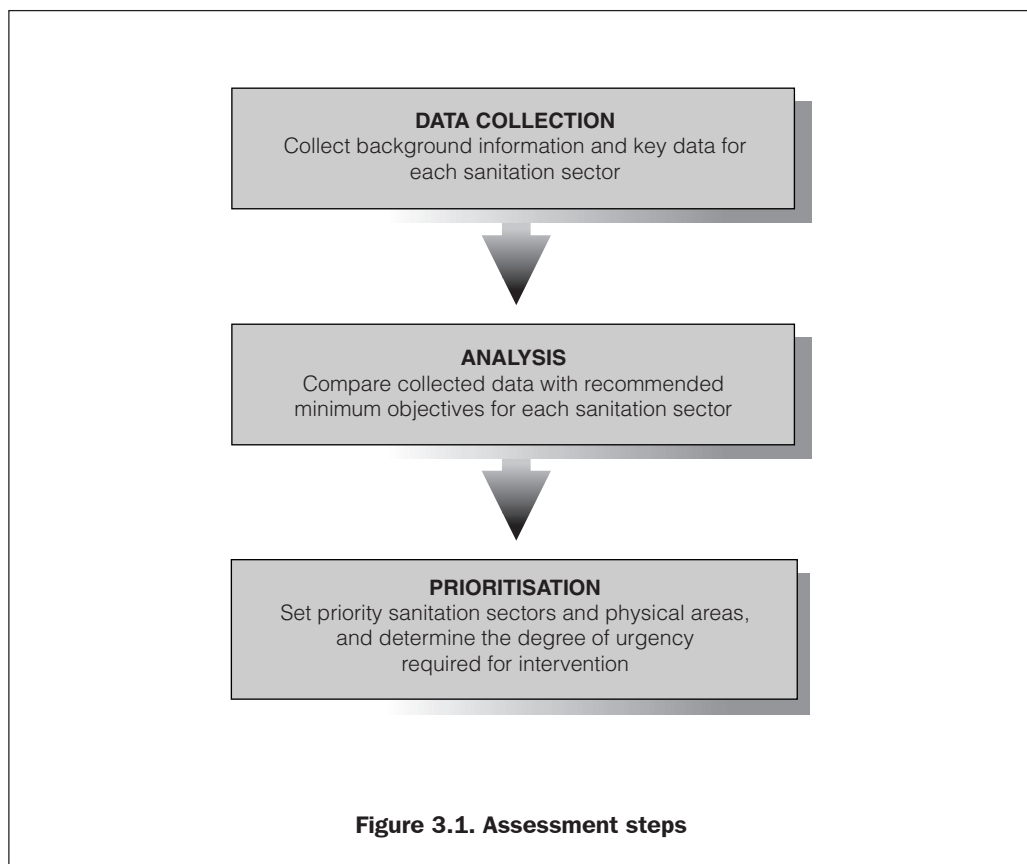

In order to conduct an assessment it is first necessary to collect information or data. This data then needs to be analysed to determine needs and set priorities.

The assessment process becomes more detailed as the programme develops. In the early stages assessment is rapid and based on observation and consultation with key informants. This initial assessment will form the basis for setting immediate priorities but should be followed up with more detailed assessment during detailed programme design. The detailed assessment involves much more in-depth consultation with the affected population and other stakeholders (see Chapter 12).

PRINCIPLES OF ASSESSMENT

3.2 Who should be involved in assessments?

Initial assessments are often conducted by experienced personnel from relief agencies, especially where external international agencies are involved, but this need not always be the case. Both rapid and more detailed assessments can be conducted by less experienced international staff, staff from local agencies and members of the affected community itself. The Guidelines for rapid assessment and priority setting (Chapter 16) aim to assist less experienced personnel in conducting initial assessments.

3.3 Data collection

Assessment involves the collection of a variety of information and data. The following quotes describe key points to remember when undertaking assessments:

- ‘In an emergency you will not be able to collect as much substantive information as you could in a period of non-emergency. **Information should therefore be collected from as many different people and sources as possible** to corroborate findings. Be aware of bias and inaccuracies. Additional data may be collected after decisions have been made for confirmation’ (House and Reed, 1997).
- ‘It is essential to **understand local political and social structures** and to be aware of conflicting interests within communities when collecting information. It is best to cross-check information using different sources. It is also important to discuss the purpose of the assessment with communities to avoid raising expectations unrealistically’ (Gosling & Edwards, 1995).
- ‘In carrying out an assessment, the principle should be to collect *enough* data to implement an *effective* response. Time spent collecting unnecessary information is time wasted. On the other hand, not doing an adequate assessment may lead to much more effort, time and money wasted on an ineffective response. Focus on the most relevant factors (**the question ‘so what?’ is a useful test of relevance** - ask it frequently)’ (Davis & Lambert, 1996). The checklists provided in Chapter 15 of the Guidelines identify the **likely** key information required.
- ‘**Keep good records** of any gathered information and store them in such a way that others can access them. Information gathering takes time and hence the assessor (or those following the assessor) should not have to repeat work due to inefficient record keeping’ (House & Reed, 1997).

Remember that in most situations things are constantly changing, it is therefore important to look at both the present situation and what is likely to happen in the near future.

3.4 Equipment

For most sanitation assessment activities there is not a great deal of equipment required. However, in conducting rapid assessments some of the following items of equipment may be useful (Table 3.1).

<i>Equipment</i>	<i>Use</i>
<ul style="list-style-type: none"> ■ Altimeter ■ Global positioning system ■ Compass / clinometer ■ Tape measure ■ Line-level ■ Mirror ■ Strong penknife ■ Torch / flashlight ■ Calculator ■ Clipboard ■ Spade 	<ul style="list-style-type: none"> Measuring elevation above mean sea level Measuring latitude, longitude and elevation Taking geographical bearings Measuring distances / dimensions Checking elevations and levels Reflecting sunlight to illuminate pits, wells, etc. Multiple use Inspecting pits, etc. Calculating ratios, percentages, etc. Carrying pen and papers for assessments Checking ground conditions

3.5 Background information

Relevant background information can often be collected before departure and en-route (if the assessor is travelling from outside the affected area), as well as in the affected area itself. It is often surprising how much information can be gathered in this way. The information gathered may include maps (topographic, geological, road, hydrogeological, demographic and rainfall), aerial photographs and satellite images. Attempts should be made to find previous surveys, studies, reports and policy papers. Information concerning the structure of national and local government, national policy and capacity to cope with an emergency is also useful. As is information concerning the capacities and intentions of other agencies working in the area.

The sources of this background information are varied and include:

- government departments of donor country;
- government department of host country;
- mapping / aerial photograph agencies or specialist shops;
- satellite image providers;
- university departments;
- government embassies;
- hospitals;
- local and international NGOs;
- travel guides, books and journals; and
- the Internet.

Up-to-date information concerning emergency refugee situations can be found on the Internet at sites such <http://www.reliefweb.int> and <http://www.unhcr.ch>. Some sources, such as satellite image providers, which usually charge for relevant information may provide this free-of-charge to non-governmental relief agencies.

PRINCIPLES OF ASSESSMENT

3.6 Observation (visual assessment)

Perhaps the simplest way of gathering information is through observation. This method allows the assessor to record non-verbal behaviour among the affected population, the physical condition of various sanitation sectors and the characteristics of the surrounding landscape. It can also explore interactions among the affected population and local residents or other stakeholders. Images can be recorded by taking photographs or video footage, but discretion is required, particularly where there are cultural sensitivities concerning photography.

3.6.1 Reconnaissance

On arrival in the field the first step in assessment is to conduct a rapid reconnaissance of the affected area. This can be done on foot or with the use of a vehicle depending on the area concerned, and may be a useful starting point in producing a simple sketch map. Transect walks can be made through the site to take notes on sanitation facilities and practices and associated indicators. A huge amount of information can be gathered in this way but care should be taken not to make sweeping assumptions based on limited observation.

3.6.2 Observing behaviour

It should be noted that observation methods based on people's behaviour are subjective and time consuming. They cannot detect what members of the affected population are thinking, and the presence of an outsider can change the behaviour of those being observed. Care must also be taken in ensuring that the observer is not seen to notice the wrong thing, and therefore observations need to be conducted in a comprehensive and systematic manner using appropriate checklists.

3.7 Mapping

Mapping is a very useful tool in obtaining an overall view of the physical situation. This can be combined with the observation process by sketching site plans or schematic maps during the initial reconnaissance. This may be used to record locations of:

- existing sanitation facilities and practices;
- key public services and institutions;
- indiscriminate disposal of excreta, solid and medical waste;
- standing water;
- water sources, storage and distribution points; and
- slopes, drainage and geological features.

Mapping can also be done quickly by community members and/or local staff. This is another way of stimulating discussion and obtaining information on a wide range of issues from those present. Maps (no matter how rough) can be very useful in co-ordination and planning meetings with other individuals, organisations and agencies.

In addition, existing maps or aerial photographs may be used to produce an environmental map of the wider area or region. Examples have been reproduced in Chapter 4.

3.8 Surveys

The term 'survey' can be used to refer to an examination of opinions or behaviour made by asking people set questions. It can also be used to refer to measuring and recording details of land, or simply to examine something carefully and systematically. Surveys can be used to collect both quantitative and qualitative information. This may be quantitative data concerning demography, health and geography, or qualitative social data such as community opinions and behaviour. There is a broad range of survey techniques which can be used for emergency sanitation programmes, including random and selective methods. There are a number of publications which examine these methods in detail, for details of social survey methods refer to Nichols (1991).

The use of surveys should be balanced against available time, human resources, logistical support, and the need for statistical analysis and interpretation of results. Some surveys, such as land surveys, may require specialists and may not be possible to undertake at the initial stage of assessment.

3.9 Interviewing

In the immediate rapid assessment stages much information can be gathered through observation, however it will probably be necessary to interview some groups and individuals. There are various interview techniques ranging from open-ended discussion with randomly selected members of the affected population to more directed interviews with key informants or personnel from NGOs.

In some cases it may help to prepare a standard questionnaire for the use of the assessor. This method should be used with all sections of society and may give the interviewer a chance to get more complete information. Furthermore, it may provide an opportunity to clarify any misunderstandings between interviewer and interviewee. However, there are disadvantages in using this method in that questions may be biased and respondents may give the answers that they believe the interviewers want. Care should be taken in conducting interviews; the assessor should avoid asking leading questions (where the desired answer is obvious) or restrictive questions (with yes or no answers only).

Interviewees can include:

- key informants (engineers, health staff etc.);
- formal leaders; and
- households and individuals.

Refugee women and children, as well as men, should be questioned. Female translators should be used where possible in interviewing women, especially in cultures where women's contact with men is restricted.

It is important to remember that in some situations, interviewers and observers may pose a threat to the people, interpreters and authorities concerned. Rapid assessment teams can compromise these groups by asking the wrong questions or quoting their answers to the wrong person (Gosling & Edwards, 1995).

PRINCIPLES OF ASSESSMENT

3.10 Group discussion (focus groups)

In group discussion the assessor guides conversation among a small group of the community with common interests. These groups may be of mixed sex and age, although single sex focus groups may promote greater freedom of expression by participants who may not want to express their opinion in a mixed group.

Discussions are semi-structured and the assessor will introduce a list of topics to encourage wider discussion among the group's members. This will enable the facilitator to learn about their concerns, opinions, problems, and what they consider to be priorities in the various sanitation sectors.

Care must be taken during the initial rapid assessment that the expectations of the affected community are not raised unduly prior to programme approval.

3.11 Measuring

Measurements can be used to determine quantities such as:

- available area;
- latrine superstructure dimensions;
- quantity of water available for handwashing / anal cleansing;
- volume of pits;
- soil infiltration rates; and
- geographical position.

Measurements are likely to require the data collector to have some skill and experience in using appropriate instruments. Assessment teams can be trained reasonably quickly for most measurements, but should be carefully supervised throughout data collection.

3.12 Counting and calculating

Many assessment methods involve counting; this could be counting numbers of people, families, facilities or resources. Time should not be wasted obtaining exact figures in the early stages of assessment. For example, if refugees are staying in family groups it may be appropriate to count the number of families. The average family size can then be estimated using a small sample group and therefore the total population may be estimated. Alternatively, other agencies (e.g. UNHCR) working in the area may have more reliable demographic figures which can be used.

Many figures obtained in assessments may be more useful expressed as percentages. In order to calculate percentages the following formula should be used:

$$\text{Percentage} = \frac{\text{number in specific group} \times 100\%}{\text{total number}}$$

EMERGENCY SANITATION

e.g. If only 2000 people have access to excreta disposal facilities yet the total population is 8000 people, the percentage of people with access to these facilities is:

$$\text{Percentage} = \frac{2000}{8000} \times 100\% = 25\%$$

3.13 Assessment reports

A brief assessment report should be produced following any rapid or detailed assessment. This can adopt the following structure:

- Author, date and location
- Purpose of assessment
- Background to situation: social, political, technical, health and environmental
- Executive summary: synopsis of assessment findings
- Summary assessment table: sector appraisal scores (see Chapter 16)
- Brief situation summary for each sanitation sector
- Brief list of recommendations

At this point the report will not include an outline plan of action but the recommendations made will form the basis of any future plan. An example of an assessment report is provided in the Case Study.

References and further reading

- Adams, John (1999) *Managing Water Supply and Sanitation in Emergencies*. Oxfam: Oxford.
- Davis, Jan and Lambert, Robert (1996) *Engineering in Emergencies: A practical guide for relief workers*. RedR / IT Publications: London.
- Gosling, Louisa and Edwards, Mike (1995) *Toolkits: A practical guide to assessment, monitoring, review and evaluation*. Save the Children: London.
- House, Sarah and Reed, Bob (1997) *Emergency Water Sources: Guidelines for selection and treatment*. WEDC, Loughborough University: UK.
- Nichols, Paul (1991) *Social Survey Methods: A fieldguide for development workers* (Development Guidelines No. 6). Oxfam: Oxford.

Chapter 4

Background information

It is important that well-documented records are kept of all background information that may have a direct or indirect effect on the programme. Reliance on non-documented information held by a single member of staff should be avoided at all costs, and all members of the assessment team should be encouraged to record activities, observations and data gathered.

4.1 General information

Before a rapid assessment is carried out general information can be recorded in a table such as Table 4.1 below. This may prove very useful as a cover page for the assessment report for the agency headquarters, for subsequent field staff or for other agencies working in the area.

EMERGENCY SANITATION

Table 4.1. Assessment cover page

Location	<i>IFRC/TRCS Camp Lugufu, Tanzania</i>
Date	<i>05/03/01</i>
Organisation carrying out assessment	<i>WEDC</i>
Name and position of assessor(s)	<i>Peter Harvey and Bob Reed (researchers)</i>
Dates of assessment	<i>03/03/01 - 04/03/01</i>
General location of affected area or site	<i>Lugufu I refugee camp, Western Tanzania, secondary scrub woodland, 100km East of Kigoma, camp established 1997</i>
Nature of emergency and likely resolutions	<i>Civil strife/unrest in DRC, no indication of likely resolution or return to DRC</i>
Origin of affected population	<i>DR Congolese refugees, few local Tanzanians</i>
Seasonal/climatic implications	<i>1000mm/year rainfall, wet season Nov.-Apr.</i>
Government involvement	<i>Ministry of Home Affairs present at camp, responsible for security</i>
Relationship between local and displaced populations	<i>Low local population but relationship reported to be good with minimal conflict</i>
Other organisations working in the area (current and planned activities)	<i>IFRC/TRCS - watsan, health, shelter; UNHCR - co-ordination; WFP - food distribution; CARE - environment; CORD - schools and social services</i>

4.2 Demographic data

The affected population includes all those people whose sanitation practices or facilities have been affected by the emergency situation. It includes refugees, internally displaced people, local populations whose sanitary facilities have been destroyed but remain in the area, and host populations who have accommodated refugees and internally displaced people and share their facilities with them.

It is important that reliable data is used and figures quoted by others are followed up to ensure that the source of these is reliable. The likely population increase over the coming month may be difficult to determine but a rough estimate can help in planning appropriate responses, especially in the immediate and short term. For this reason, the total affected population figure should include the current population **and** the expected increase in population over the next month.

The total affected population will be used to find out the total ratio of facilities to the affected population.

BACKGROUND INFORMATION

Total affected population = present population in the affected area +
potential increase in population over next month

Ratio of facilities = total affected population ÷ total number of facilities

This gives the number of people per facility.

Furthermore, if necessary the gender/age profile can be used to find the ratio of facilities available to different groups. It will also help the assessor to identify the most vulnerable groups in the affected area and determine any imbalances that may affect programme implementation.

e.g. Ratio of facilities (for females) = total affected population (female) ÷ total number of facilities available to them

A table such as Table 4.2 can be used to record the demographic structure of the affected population.

Table 4.2. Demographic profile					
Age range	Male	Female	Disabled	Total	Remarks
0-5 years	4,262	4,365	No data	8,627	
5-18	11,875	11,033		22,908	
19-60	11,479	12,171		23,650	
60+	485	736		1,221	
Totals	28,101	28,305		56,406	
% of totals belong to vulnerable groups				2% (1,006)	Widows>50; + disabled
Number of households				11,280	Avg family size = 5
Likely increase in population over next month				0	New arrivals directed to Lugufu 2 camp

4.3 Physical features

In addition to background information concerning the affected population, it is important that information on the physical environment is recorded. This can include any or all of the following:

- Large-scale features such as mountains, forest, marshland, vegetation and water sources
- Human features including settlement patterns, public places, industry, roads and institutions
- Concentration of affected population
- Areas where future expansion is likely
- Rock and soil types
- Groundwater levels (if known)
- Location and types of existing sanitary facilities with estimates of key distances
- Location of indiscriminate dumping of solid waste
- Location of indiscriminate dumping of medical waste
- Areas of indiscriminate defecation
- Water storage and distribution points
- Pooling of wastewater
- Burial / cremation sites
- Slope directions and drainage patterns

Much of this is best shown on a map. In addition to such features, the physical space available is a key factor in selecting and designing appropriate emergency interventions. The total area available can be used to calculate the average area per member of the affected population.

The average area available per member of the affected population =

$$\frac{\text{Total affected population}}{\text{Total area available for affected population}}$$

The total area should be large enough to be used for shelters, roads, sanitation facilities, water supply facilities, schools, health centres and feeding centres / markets.

UNHCR (2000) gives the following recommended minimum area requirements for refugee sites:

Ideally, the recommended minimum surface area is 45m² per person when planning a refugee camp (including garden space). However, the actual surface area per person (excluding garden space) should not be less than 30m² per person.

BACKGROUND INFORMATION

4.3.1 Maps

The most effective way of presenting the prevalent physical features is through the production of appropriate maps. This is likely to include an environmental map of the entire affected area or region, as well as a larger scale sketch map of the camp or dwelling areas.

Information for maps can be gathered through interview and discussion and other participatory approaches (see 12.6). Global Positioning Systems (GPS) can also be used for rapidly producing to-scale maps.

Environmental sketch maps are typically of a scale of 1:5000 or 1:10,000 and can be produced from observation, existing maps, aerial photographs and satellite images. Such maps are designed to show the key physical and human environmental features of the area. Figure 4.1 shows an example map from Tanzania.

A sketch map of the camp or dwelling areas can be very useful to indicate the location of key practices, facilities and problems affecting the population. This is generally a schematic map and not to scale. An example from Tanzania is shown in Figure 4.2.

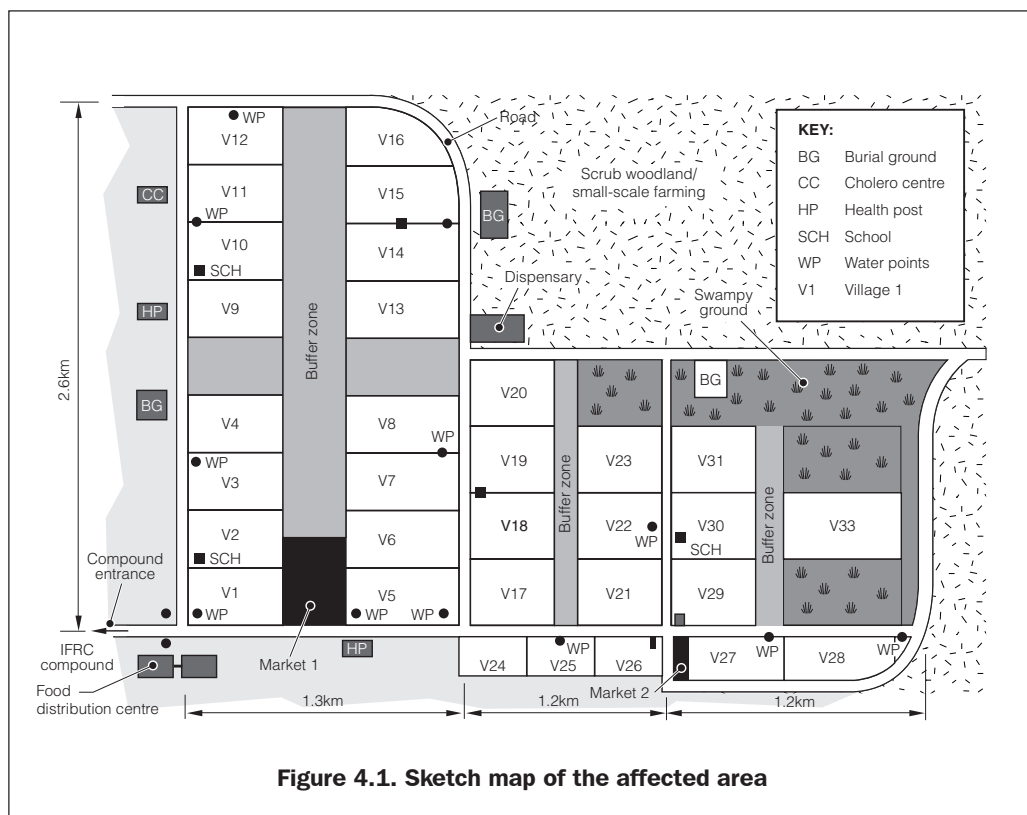

EMERGENCY SANITATION

4

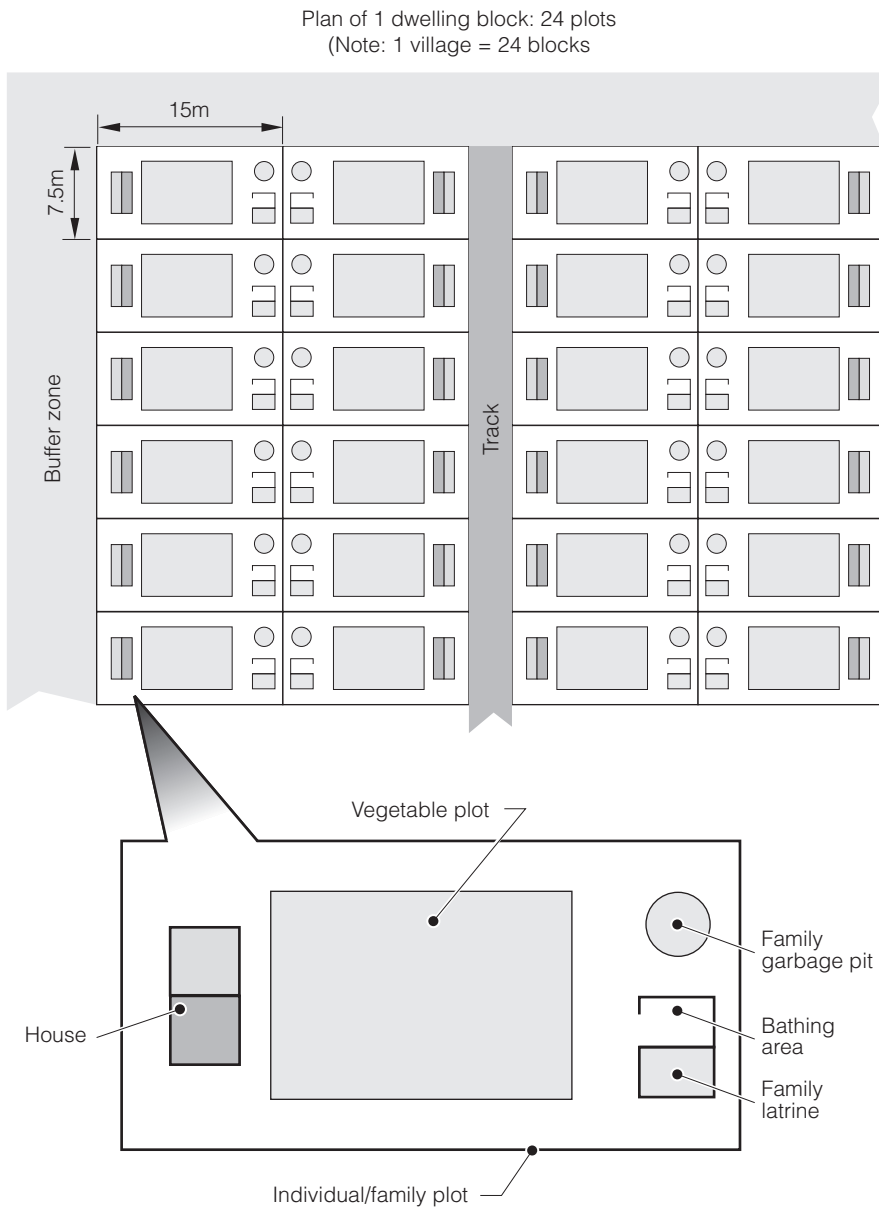

Figure 4.2. Sketch map of dwelling area

BACKGROUND INFORMATION

4.3.2 Ground conditions

The soil and rock condition is particularly relevant in wastewater management and excreta disposal where pits or soakaways are to be used, and is a key factor in the selection of appropriate actions.

Hard rocky ground may make manual excavation impossible, whilst heavy clayey soil is likely to limit infiltration severely. Unstable sandy soil will also make excavation difficult if the pit walls collapse easily whilst digging.

Table 4.3 gives guideline infiltration rates for clean water and wastewater in different types of soil and simple descriptions to assist soil identification. Note that infiltration rates for wastewater are much lower than those for clean water and are also likely to decrease with time as the soil becomes saturated and blocked.

Where the information is insufficient to determine the suitability of ground conditions a simple method to estimate infiltration in the field can be used. One such method is highlighted below (adapted from Davis and Lambert, 1996). This will give a general feel for the infiltrative capacity of the soil under test and provide relevant information for infiltration from soak pits or latrines. Such a test should be undertaken at the same depth as the base of the pit to ensure that the test is not distorted by any variation in material with depth.

Soil type	Description	Infiltration rate litres/m ² /day (mm/day)	
		Clean water	Wastewater
Gravel, coarse and medium sand	Moist soil will not stick together	1,500-2,400	50
Fine and loamy sand	Moist soil sticks together but will not form a ball	720-1,500	33
Sandy loam and loam	Moist soil forms a ball but still feels gritty when rubbed between fingers	480-720	24
Loam, porous silt loam	Moist soil forms a ball which easily deforms and feels smooth between fingers	240-480	18
Silty clay loam and clay loam	Moist soil forms a strong ball which smears when rubbed but does not go shiny	120-240	8
Clay	Moist soil mould like plasticine and feels very sticky when wetter	24-120	Unsuitable for soak pits

^aSource: Reed and Dean, 1994

Method: Force an open steel cylinder (i.e. without ends) of about 300mm diameter a few centimetres into the soil so that it stands upright. Place an upright ruler or gauge stick marked in millimetres into the cylinder. Fill the cylinder with clean water and measure the fall in water level at convenient intervals (5, 10, 20, 30 minutes) as water infiltrates into the soil.

Interpretation: Determine the infiltration rate during each time period and take the average of the results. This will give a very rough guide to the infiltration rate, which is likely to be all that is required for this application.

$$\text{The percolation value (or infiltration rate) in mm /day} = \frac{\text{drop in level (mm)}}{\text{time (days)}}$$

e.g. If the water level drops 12mm in 30minutes:

$$\text{Infiltration} = \frac{12}{30} \times 60 \times 24 = 576 \text{ mm/day (typical value for sandy loam)}$$

*Note: The value in mm/day is always **equal** to the value in litres/m²/day*

For soakpits or pit latrines to function correctly the infiltration rate for **clean** water should be **at least** 120mm/day (see Table 4.3).

4.3.3 Groundwater level

In addition to the rock and soil conditions, groundwater levels may be a vital physical factor in determining appropriate actions. This is especially the case where high water tables are predominant, which may make traditional infiltration methods for excreta or wastewater disposal impossible. However, this will depend on whether there is sufficient dry space above the water table to create a hydraulic gradient and contribute to the infiltration area.

Seasonal variations should also be taken into account, pits which are dry during the dry season may fill with water during wetter periods of the year. Estimates of groundwater levels can be made through observation of nearby wells and interviews with local people. If the water table is so deep that this is impossible then groundwater is not likely to pose a serious constraint in terms of pit construction or infiltration.

4.3.4 General description of affected area

A general description of the affected area may be useful in complementing the maps. This can include any information that it was not possible to show in the maps, such as vulnerability of area to natural threat, available space per affected person, available space for construction of new sanitary facilities, soil condition and groundwater levels.

A completed example is presented in the Case Study.

4.4 Other organisations

It is important for an agency to interact with other organisations working in the affected area. These may include other aid agencies, host institutions (churches, hospitals, etc.) and government authorities. Agency staff should establish key contacts within such organisations and ensure that regular consultation occurs. This should avoid unnecessary duplication of activities and will minimise tension or conflict between organisations. Regular inter-agency meetings should be set up and should be open to relevant government personnel.

References and further reading

- Adams, John (1999) *Managing Water Supply and Sanitation in Emergencies*. Oxfam: Oxford.
- Davis, Jan and Lambert, Robert (1996) *Engineering in Emergencies: A practical guide for relief workers*. RedR / IT Publications: London.
- Médecins Sans Frontières (1994) *Public Health Engineering in Emergency Situation*. Médecins Sans Frontières: Paris.
- Reed, R. and Dean, P.T. (1994) Recommended Methods for the Disposal of Sanitary Wastes from Temporary Field Medical Facilities. *Disasters* Vol 18, No 4.

Chapter 5

Recommended minimum objectives

This chapter contains detailed information on the recommended minimum objectives for each sanitation sector and definitions of the key terms used. These objectives are broadly based on the *Sphere Project (1999) Minimum Standards in Water Supply and Sanitation*. The *Sphere Project* is the product of international inter-agency collaboration and its aim is to improve the quality of assistance provided to people affected by disasters, and to enhance the accountability of the humanitarian system in disaster response. The minimum standards describe what people should have as a minimum for their health and dignity. Agencies should strive to do better wherever possible.

5.1 Minimum objectives

The minimum objectives are the recommended levels to be aimed for at respective stages of an emergency sanitation programme. Whilst they are based on the *Sphere Project* minimum standards they have been considerably expanded to incorporate more detailed objectives for each sanitation sector. These additions and any interpretation are solely those of the authors and do not necessarily reflect the opinions of the *Sphere Project*, however they were agreed by the advisory panel for this book.

Each of the following sections (5.2 – 5.7) consists of a table containing the minimum objectives for that sector. These are divided into immediate, short-term and long-term objectives for quality, quantity and usage of services. Each table is followed by a series of definitions of terms used within that table.

The objectives developed here are **not** standards, they are simply designed to guide and assist the practitioner in achieving adequate and appropriate service levels for each of the sanitation sectors. ‘Emergency’ situations vary greatly and these objectives should always be viewed in the broader context of local conditions and adapted accordingly.

Simply because objectives are set does not mean that agencies should strive to achieve these at all costs. A consultative approach should always be taken in programme design and this may identify times at which some objectives may be inappropriate or irrelevant.

Many of the terms and descriptions used in the Guidelines checklists and analysis tables are identical to those in the minimum objective tables and hence reference to these definitions can be used for clarification to assist in the completion of rapid assessments. Worked examples of checklists and analysis tables can be found in the Case Study.

EMERGENCY SANITATION

5.2 Excreta disposal

Table 5.1. Recommended minimum objectives for safe excreta disposal

<i>Criteria</i>	<i>Immediate</i>
Quality	<ul style="list-style-type: none"> • Technically basic* • Barely socially and culturally acceptable** • Basic health protection measures in place★ • Technology sustainable for one month★★
Quantity	<ul style="list-style-type: none"> • Ratio of one space/cubicle to 100 persons accessible to all population or immediate responses only† • Maximum walking distance 70m (one way) • Availability of sufficient numbers of facilities at: <ol style="list-style-type: none"> 1. Medical centres (one latrine space to 50 beds or 100 outpatients) 2. Schools (one to 50 girls and one to 100 boys) 3. Market areas (one to 100 stalls) 4. Feeding centres (one to 100 adults and one to 50 children)
Usage	<ul style="list-style-type: none"> • 50% of affected population has access to domestic facilities (100% in medical and feeding centres) ^ • 50% using facilities correctly on a regular basis

RECOMMENDED MINIMUM OBJECTIVES

Short-term	Long-term
<ul style="list-style-type: none"> • Technically appropriate* • Socially and culturally acceptable** • Minimal health hazard★ • Technology sustainable for six months★★ 	<ul style="list-style-type: none"> • Technically very appropriate* • Very socially and culturally acceptable** • No health hazard★ • Technology sustainable for three years★★
<ul style="list-style-type: none"> • Ratio of one space/cubicle to 50 persons accessible to all population • Maximum walking distance 50m (one way) • Availability of sufficient numbers of facilities at: <ol style="list-style-type: none"> 1. Medical centres (one latrine space to 20 beds or 50 outpatients) 2. Schools (one to 30 girls and one to 60 boys) 3. Market areas (one to 50 stalls) 4. Feeding centres (one to 50 adults and one to 20 children) 	<ul style="list-style-type: none"> • Ratio of one space/cubicle to 20 persons accessible to all population • Maximum walking distance 25m (one way) • Availability of facilities at: <ol style="list-style-type: none"> 1. Medical centres (one latrine space to 10 beds or 20 outpatients) 2. Schools (one to 15 girls and one to 30 boys) 3. Feeding centres (one to 20 adults and one to 10 children) 4. Market areas (one to 20 stalls) 5. Offices (one to 20 staff)
<ul style="list-style-type: none"> • 75% of affected population has access to domestic facilities (100% in medical and feeding centres) ^ • 75% using facilities correctly on a regular 	<ul style="list-style-type: none"> • 95% of affected population has access to domestic facilities (100% in medical and feeding centres) ^ • 95% using facilities correctly on a regular basis

EMERGENCY SANITATION

Definitions of excreta disposal terminology

(see Chapter 6 for further information)

***Technical appropriateness**

Technical appropriateness includes the following design factors:

- Keyhole size and shape (of slab)
- Foot rest position (if applicable)
- Minimum dimension for inside latrine 1m x 1m
- Superstructure provides necessary privacy and appropriate weather protection
- Drainage around excreta disposal facilities
- Access path to the space/facilities
- Seasonal variation has minimum affect on access to the space/facilities
- Accessible and easy to use by all vulnerable groups (i.e. children, women, especially pregnant women, disabled and the elderly)
- Lit at night if necessary
- Personal security for vulnerable groups especially women

Inappropriate: None of the above

Technically basic: Few of the above

Appropriate: Most of the above

Very appropriate: All of the above

****Social and cultural acceptability**

In determining whether current provision is socially and culturally acceptable, the following factors should be taken into consideration:

- Religious or cultural factors affecting use of facilities
- Methods of anal cleansing
- Preferred defecation position
- Need for privacy
- Segregation of sexes or different groups and individuals for whom it is culturally unacceptable to share a latrine
- Provision for the disposal of women's sanitary protection or privacy for washing and drying sanitary protection cloths
- Cultural taboos
- Special arrangements for children

Very unacceptable: None of the above

Barely acceptable: Few of the above

Acceptable: Most of the above

Very acceptable: All of the above

★Potential health hazard of current system

The potential health hazard of the current system can be divided into the following categories of measurement:

Major hazard: Open and indiscriminate defecation being practiced by most of the affected population; no anal cleansing materials available; no handwashing facilities near latrines, or

RECOMMENDED MINIMUM OBJECTIVES

no soap and water available for family latrines; high population of excreta-related vectors; potential water source (surface or ground) pollution from human excreta; and no O&M structures in place.

Basic health protection measures in place: Controlled defecation in designated locations; some anal cleansing materials available; some handwashing facilities available; possibility of water source (surface or ground) pollution minimised; and some O&M structures in place.

Reduced hazard: One space available per 50 people and not more than 50m away from dwellings; anal cleansing materials available; handwashing facilities near public facilities; some measure of vector control in place; no water source pollution; and community mobilisation and O&M activities taking place.

Minimal hazard: One space available per 20 people and not more than 25m away from dwellings; widespread availability of anal cleansing materials, handwashing facilities near public facilities and availability of soap and water at family latrines; minimum vector population; no water source pollution; and affected population responsible for O&M activities.

Measures that will increase the impact on disease transmission include:

- the facilities are hygienic, i.e. they are kept and maintained in a clean state inside and outside, they do not present a health hazard to all users and they minimise fly and mosquito populations;
- anal cleansing material is either accessible or has been provided;
- handwashing facilities are available at public latrines and soap and water at family latrines;
- the base of pits are at least 1.5m above the wet season water table and facilities are at least 30m away from surface water sources; and
- in open defecation systems the drainage system does not run towards any surface water source and they are sited downstream of all water sources.

★★Sustainability of facilities

The sustainability of facilities is a measure of how long they are likely to be able to be used and maintained in a safe and appropriate manner, without detrimental effect to the community or environment. This includes latrine pit and superstructure life, as well as the ability and willingness of users to maintain facilities, appropriate funding, equipment and staff skills. Facilities should be designed with these factors in mind. Design lives are divided into immediate (<one month), short-term (three-six months) and long-term (>one year).

†Immediate responses

Where the term ‘immediate responses’ is used this refers to immediate interventions which are designed to contain excreta. These include controlled open-field defecation which may provide adequate defecation space but does not provide any individual latrine spaces. Such measures only satisfy immediate standards and must not be relied upon beyond this.

^ Accessibility of facilities

The accessibility of facilities means how easily various groups (including vulnerable groups) of the affected population have access to the facilities. This includes physical access such as paths or roads, as well as segregation to provide access to minority or disadvantaged groups.

EMERGENCY SANITATION

5.3 Solid waste management

Table 5.2. Recommended minimum objectives for solid waste management

Criteria		Immediate
Quality		<ul style="list-style-type: none"> • Technically basic* • Basic health protection measures in place★ • Technology sustainable for one month★★
Quantity	Storage and collection	<ul style="list-style-type: none"> • One bin or container (100litre) to 200 people for domestic solid waste • Maximum walking distance from bin 70m • Bins available in feeding centres, market places and distribution centres • One bin (100litre) to 40 market stalls • One bin (100litre) to 500 people using feeding centres
	Transport	<ul style="list-style-type: none"> • 0.2litre collection vehicle volume per person per day • 5litre collection vehicle volume per market stall per day
	Disposal	<p><i>Direct (on-site)</i></p> <ul style="list-style-type: none"> • 45m to family pit • 200m to communal pit • 6m³ pit/ 200 persons <p><i>Remote (off-site)</i></p> <ul style="list-style-type: none"> • 500m to final disposal site from nearest habitable building • 0.25m³ / person for landfilling • 6m³ pit/ 200 persons
Usage		<ul style="list-style-type: none"> • 50% of affected population has access ^ to facilities and is using them correctly on a regular basis • 50% of collected solid waste transported correctly • 50% of collected solid waste disposed of correctly

RECOMMENDED MINIMUM OBJECTIVES

Short-term	Long-term
<ul style="list-style-type: none"> Technically appropriate* Minimal health hazard★ Technology sustainable for six months★★ 	<ul style="list-style-type: none"> Technically very appropriate* No health hazard★ Technology sustainable for three years★★
<ul style="list-style-type: none"> One bin (100litre) to 100 people for domestic solid waste Maximum walking distance from bin 50m Bins available in feeding centres, market places and distribution centres One bin (100litre) to 20 market stalls One bin (100litre) to 200 people using feeding centres 	<ul style="list-style-type: none"> One bin (100litre) to 50 people for domestic solid waste Maximum walking distance from bin 15m Bins available in feeding, centres market places and distribution centres One bin (100litre) to 10 market stalls One bin (100litre) to 100 people using feeding centres
<ul style="list-style-type: none"> 0.4litre collection vehicle volume per person per day 10litre collection vehicle volume per market stall per day 	<ul style="list-style-type: none"> 1.0litre collection vehicle volume per person per day 20litre collection vehicle volume per market stall per day
<p><i>Direct (on-site)</i></p> <ul style="list-style-type: none"> 30m to family pit 150m to communal pit 6m³ pit/ 100 persons <p><i>Remote (off-site)</i></p> <ul style="list-style-type: none"> 750m to final disposal site from nearest habitable building 0.25m³ / person for landfilling 6m³ pit/ 100 persons 	<p><i>Direct (on-site)</i></p> <ul style="list-style-type: none"> 6m³ pit/ 50 persons 15m to family pit 100m to communal pit <p><i>Remote (off-site)</i></p> <ul style="list-style-type: none"> 1000m to final disposal site from nearest habitable building 0.25m³ / person for landfilling 6m³ pit/ 100 persons
<ul style="list-style-type: none"> 75% of affected population has access ^ to facilities and is using them correctly on a regular basis 75% of collected solid waste transported correctly 75% of collected solid waste disposed of correctly 	<ul style="list-style-type: none"> 95% of affected population has access ^ to facilities and is using them correctly on a regular basis 95% of collected solid waste transported correctly 95% of collected solid waste disposed of correctly

EMERGENCY SANITATION

Definitions solid waste management terminology

(see Chapter 7 for further information)

***Technical appropriateness**

Inappropriate: Open and indiscriminate dumping of solid waste; no storage, collection, transport and disposal facilities; and no formal systems in place for solid waste management.

Technically basic: Solid waste disposed in designated areas which are cleared at least every two weeks; and community mobilisation in place to control open dumping.

Appropriate: On-site disposal facilities in place or basic containers provided and emptied at least every one-two weeks for domestic areas and two-three times a week at markets and feeding centres; off-site disposal in designated areas; and basic management system in place.

Very appropriate: On-site disposal facilities in place or well-designed solid waste containers emptied at least weekly and every day at markets and feeding centres; suitable collection vehicles of sufficient capacity and design used for off-site disposal to well-designed pits or landfill; and programme managed by skilled staff through formal structures integrated with other sanitation and health activities.

★Potential hazard to health

The potential hazard to health of solid waste systems can be divided into the following categories of measurement:

Major hazard: There is pollution of food and water sources; high vector population close to habitable buildings; medical waste mixed with general waste; no tools or protective clothing provided for workers; and access for people and animals is uncontrolled.

Basic health protection measures in place: Medical waste is separated from general waste; no pollution of food and water sources; and workers are provided with basic tools, boots and gloves.

Reduced hazard: Medical waste is separated from general waste; no pollution of food and water sources; workers are provided with basic tools, boots and gloves; access to off-site disposal facilities by people and animals is controlled; and disposal site does not cause smoke or odour hazard to communities.

Minimal hazard: Medical waste is separated from general waste; no pollution of food and water sources; workers are provided with full complement of tools and protective clothing plus facilities for changing and bathing; animals are prevented from accessing storage and disposal sites; and disposal site does not cause smoke or odour hazard to communities.

RECOMMENDED MINIMUM OBJECTIVES

Measures that will increase the impact on disease transmission and minimise health hazards include:

- The bases of communal pits, general land-filling sites and medical waste pits should be at least 1.5m above the wet season water table (especially where groundwater is used for water supply) and 30m from surface water sources,
- Appropriate drainage systems should be in place to avoid the flooding of pits and landfill areas.
- Communal pits should be fenced to protect people (especially children) from falling into them.
- Insect-vectors and vermin numbers should be minimised by burning and covering waste with layers of soil.
- At no time should medical waste be mixed with domestic and communal waste.
- All workers handling solid waste and medical waste should be provided with and wear protective clothing.

5

★★Sustainability of facilities

The sustainability of facilities is a measure of how long they are likely to be able to be used and maintained in a safe and appropriate manner, without detrimental effect to the community or environment. This includes pit or vehicle life, as well as the ability and willingness of users to maintain facilities, appropriate funding, equipment and staff skills. Facilities should be designed with these factors in mind. Design lives are divided into immediate (< one month), short-term (three-six months) and long-term (> one year).

^ Accessibility of facilities

The accessibility of facilities means how easily various groups (including vulnerable groups) of the affected population have access to the facilities. This includes physical access such as paths or roads, as well as segregation to provide access to minority or disadvantaged groups.

Recycling

A long-term goal should be to promote the recycling of solid waste (excluding medical waste). This is more environmentally friendly and can lead to income-generation activities which may create less dependency on external aid agencies. The way that relief goods are packaged is a key factor in minimising waste and promoting recycling.

EMERGENCY SANITATION

5.4 Waste management at medical centres

Table 5.3. Recommended minimum objectives for waste management at medical centres

<i>Criteria</i>		<i>Immediate</i>
Quality		<ul style="list-style-type: none"> • Technically basic* • Basic health protection measures in place★ • Technology sustainable for one month★★
Quantity	Storage and collection	<ul style="list-style-type: none"> • One set of three segregated containers per 40 beds • 20m average one-way distance to containers
	Transport	<ul style="list-style-type: none"> • Transport volume of 0.5litre per bed
	Disposal	<ul style="list-style-type: none"> • Original pit volume of 400litre per bed • Capacity of incinerator insufficient† • Incinerator 5m from nearest habitable building • Pit 50m from nearest habitable building
Usage		<ul style="list-style-type: none"> • 75% of waste appropriately collected and sorted • 75% of collected waste transported correctly • 75% of collected waste disposed of correctly

RECOMMENDED MINIMUM OBJECTIVES

<i>Short-term</i>	<i>Long-term</i>
<ul style="list-style-type: none"> • Technically appropriate* • Minimal health hazard★ • Technology sustainable for six months★★ 	<ul style="list-style-type: none"> • Technically very appropriate* • No health hazard★ • Technology sustainable for three years★★
<ul style="list-style-type: none"> • One set of three segregated containers per 30 beds • 10m average one-way distance to containers 	<ul style="list-style-type: none"> • One set of three segregated containers per 20 beds • 5m average one-way distance to containers
<ul style="list-style-type: none"> • Transport volume of 1.0litre per bed 	<ul style="list-style-type: none"> • Transport volume of 1.5litre per bed
<ul style="list-style-type: none"> • Original pit volume of 800litre per bed • Capacity of incinerator sufficient† • Incinerator 15m from nearest habitable building • Pit 75m from nearest habitable building 	<ul style="list-style-type: none"> • Original pit volume of 1200litre per bed • Capacity of incinerator ideal† • Incinerator 30m from nearest habitable building • Pit 100m from nearest habitable building
<ul style="list-style-type: none"> • 90% of waste appropriately collected and sorted • 90% of collected waste transported correctly • 90% of collected waste disposed of correctly 	<ul style="list-style-type: none"> • 100% of waste appropriately collected and sorted • 100% of collected waste transported correctly • 100% of collected waste disposed of correctly

EMERGENCY SANITATION

Definitions of medical waste management terminology

(see Chapter 8 for further information)

***Technical appropriateness**

Inappropriate: Medical centres do not have any segregated medical waste management system in place and medical waste is indiscriminately disposed of with domestic waste in public or dwelling areas. There are no formal storage, collection; transport or disposal facilities for medical waste

Technically basic: All medical centres have a very basic medical waste management system in place which is technically unsophisticated. Medical waste and general waste are segregated but all types of medical waste are disposed of together in a pit where they are burned at low temperature.

Appropriate: All medical centres have a medical waste management system in place which is technically appropriate. General waste, pathological waste and sharps/needles are segregated into different collection containers at source. These are safely transported to the final disposal sites where medical waste is incinerated and the ash deposited in a deep pit.

Very appropriate: All medical centres have a medical waste management system in place and this is technically appropriate. General waste, pathological waste and sharps/needles are segregated into different collection containers at source and transported separately. Disposal facilities are a combination of incineration and sealed disposal pits. The medical waste is incinerated at the correct temperature.

★Potential hazard to health

The potential hazard to health of waste management systems at medical centres can be divided into the following categories of measurement:

Major hazard: The pollution of food and water sources; high vector population close to habitable buildings; medical waste mixed with general waste; no tools, gloves or protective clothing are provided for workers; no disinfection; no incineration; and access for people and animals is uncontrolled.

Basic health protection measures in place: Medical waste separated from general waste; no pollution of food and water sources; workers are provided with basic tools, boots and gloves; and medical waste is disposed of in pits where it is burned.

Reduced hazard: Medical waste segregated into sharps, pathological and general waste and stored and transported in sealed containers; no pollution of food and water sources; workers are trained and provided with basic tools, boots and gloves; access to disposal facilities is controlled; and after incineration ash is deposited in deep pits.

Minimal hazard: Medical waste segregated into sharps, pathological and general waste and disinfected, stored and transported separately in sealed containers; no pollution of food and water sources; workers are fully trained and provided with full complement of tools and protective clothing plus facilities for changing and bathing; access to incinerator which operates at the correct temperature and does not cause smoke or odour hazard to communities is controlled; and ash from incineration deposited in a deep sealed pit.

Measures that will increase the impact on disease transmission and minimise health hazards include:

RECOMMENDED MINIMUM OBJECTIVES

- The base of pits for medical waste should be at least 1.5 m above the wet season water table and at least 30m from surface water sources.
- Appropriate drainage systems should be in place to avoid the flooding of pits and landfill areas.
- Medical waste should be disinfected before disposal (but note 8.5.3).
- All staff handling medical waste should be properly trained and provided with and wear protective clothing at all times.
- At the source, medical waste should be segregated into pathological waste, sharps, etc., and transported and disposed of accordingly.
- Medical waste containers should be sealed and leak-proof.
- Medical waste storage places, collection areas, and transport modes should be regularly disinfected.
- At no time should medical waste be disposed of at general waste sites.
- Incinerators should be correctly designed, constructed and operated to minimise the pollution of the environment.
- All ashes from incinerators should be disposed of in deep pits.
- If medical waste cannot be incinerated correctly, it should be buried in plastic containers to minimise the contamination of soil and water.

★★Sustainability of facilities

The sustainability of facilities is a measure of how long they are likely to be able to be used and maintained in a safe and appropriate manner and without detrimental effect to the community or environment. This includes pit or incinerator life, as well as the ability and willingness of users to maintain facilities, appropriate funding, adequate equipment and staff skills. Facilities should be designed with these factors in mind. Design lives are divided into immediate (< one month), short-term (three-six months) and long-term (> one year).

†Capacity of incinerator

The capacity of the incinerator applies to the mass it is able to incinerate and the temperature at which it operates or the effectiveness of incineration. The minimum objectives have been divided into the following categories:

Very insufficient: Not properly incinerated – non-combusted solid waste clearly visible after attempted incineration, or the incinerator is unable to cope with the quantity of medical waste produced per day.

Insufficient: Incinerated at low temperature, some non-combusted waste after attempted incineration but most rendered inert; and able to cope with majority of medical waste produced each day.

Sufficient: All generated medical waste successfully incinerated each day to produce residual ash.

Ideal: All generated waste successfully incinerated each day at 1,000°C or above; and a uniform fine ash is produced.

It is estimated that an ideal incinerator should be able to incinerate 10kg of waste/ 10,000 people/day based on the total affected population.

It is important that medical waste is incinerated at the correct temperature. It is recommended that this should be a minimum temperature of 1,000°C. This will not be obtained by open burning in pits and will only be reached in a properly designed and operated incinerator.

EMERGENCY SANITATION

5.5 Disposal of dead bodies

Table 5.4. Recommended minimum objectives for safe excreta disposal

<i>Criteria</i>	<i>Immediate</i>
Quality	<ul style="list-style-type: none"> • Technically basic* • Socially and culturally unacceptable** • Basic health protection measures in place★ • Technology sustainable for one month★★
Quantity	<ul style="list-style-type: none"> • Burial: 500m² of land available per 10,000 people • Cremation: basic supply of fuel† • Distance from nearest habitable building to burial or cremation site 100m • Minimum of 75% of bodies collected and buried/cremated before decomposition
Usage	<ul style="list-style-type: none"> • Transport, cremation and/or burial facilities accessible to 75% of the population

RECOMMENDED MINIMUM OBJECTIVES

<i>Short-term</i>	<i>Long-term</i>
<ul style="list-style-type: none"> • Technically appropriate* • Socially and culturally acceptable** • Minimal health hazard★ • Technology sustainable for six months★★ 	<ul style="list-style-type: none"> • Technically very appropriate* • Very socially and culturally acceptable** • No health hazard★ • Technology sustainable for three years★★
<ul style="list-style-type: none"> • Burial: 1,000m² of land available per 10,000 people • Cremation: adequate supply of fuel† • Distance from nearest habitable building to burial or cremation site 300m • Minimum of 90% of bodies collected and buried/cremated before decomposition 	<ul style="list-style-type: none"> • Burial: 1,500m² of land available per 10,000 people • Cremation: plentiful supply of fuel† • Distance from nearest habitable building to burial or cremation site 500m • Minimum of 100% of bodies collected and buried/cremated before decomposition
<ul style="list-style-type: none"> • Transport, cremation and/or burial facilities accessible to 90% of the population 	<ul style="list-style-type: none"> • Transport, cremation and/or burial facilities accessible to 100% of the population

EMERGENCY SANITATION

Definitions of terminology for disposal of the dead

(see Chapter 9 for further information)

***Technical appropriateness**

The different levels of technical appropriateness are defined as follows:

Inappropriate: The affected population has no access to land, resources or tools to bury or cremate dead bodies.

Technically basic: The affected population has some access to designated land/fuel, transport and tools. Dead bodies are buried in shallow graves or crudely cremated.

Appropriate: Most of affected population has access to designated sites, fuel, transport and tools to enable them to bury or cremate dead bodies. Bodies are buried at a depth of at least 1.5m or cremated. Some O&M structures in place.

Very appropriate: The whole of the affected population has access to designated sites, fuel, transport and tools to enable them to bury or cremate dead bodies. Bodies are buried at a depth of at least 2m or cremated at sufficient temperature. Well-managed O&M structures in place. A field morgue of 10 bodies capacity per 10,000 people is available.

****Social and cultural acceptability**

In determining whether current provision is socially and culturally acceptable, the following factors should be taken into consideration:

- Religious or cultural factors affecting the disposal of the dead
- Traditional funeral practices
- Cultural taboos
- Special arrangements for different religious groups within the community
- Special arrangements for different social groups within the community

Very unacceptable: None of the above

Barely acceptable: Few of the above

Acceptable: Most of the above

Very acceptable: All of the above

★Potential hazard to health

The potential hazard to health of the disposal of dead bodies can be divided into the following categories of measurement:

Major hazard: No disposal system is in place; high population of vectors and no protection of bodies from animals; actual or potential water source (surface or ground) pollution from dead bodies; and likely contamination from infected corpses. Bodies not disposed of promptly. During a cholera or ebola epidemic dead bodies disposed of without disinfection.

RECOMMENDED MINIMUM OBJECTIVES

Basic health protection measures in place: Technically basic measures in place, but still high population of vectors and only limited protection from animals. During a cholera or ebola epidemic some dead bodies disposed of without disinfection creating potential for contamination.

Reduced hazard: Technically appropriate facilities in place; some measure of vector population control in place; no water source pollution; unlikely transmission of disease; O&M activities in place; all bodies from cholera or ebola epidemics disinfected before disposal and protective clothing provided for workers where appropriate.

Minimal hazard: Very technically appropriate facilities in place, minimum vector population, no water source pollution, and no contamination from infected corpses. Well-managed O&M activities are in place; all bodies from cholera or ebola epidemics are disinfected before disposal and protective clothing provided for workers where appropriate.

Measures that will increase the impact on disease transmission and minimise health hazards include:

- Workers handling dead bodies should be provided with and wear protective clothing to minimise contamination, especially those workers disposing of dead bodies from epidemics.
- All bodies should be collected and stored promptly.
- The burial activities should not pollute ground or surface water sources.
- Burial and cremation sites should not become breeding grounds for vectors or pests.

★★Sustainability of facilities

The sustainability of facilities is a measure of how long they are likely to be able to be used and maintained in a safe and appropriate manner, without detrimental effect to the community or environment. This includes cemetery life or fuel availability, as well as the ability and willingness of users to maintain facilities, appropriate funding, equipment and staff skills. Facilities should be designed with these factors in mind. Design lives are divided into immediate (< one month), short-term (three-six months) and long-term (> one year).

†Availability of fuel for cremation

It is difficult to determine the appropriate amount of fuel necessary for cremation, since this will depend upon cultural practice and type of fuel available. This will therefore have to be determined by observation of the current scenario, whereby fuel availability can be expressed in terms of none, basic, adequate and plentiful.

EMERGENCY SANITATION

5.6 Wastewater management

Table 5.5. Recommended minimum objectives for wastewater management

<i>Criteria</i>	<i>Immediate</i>
Quality	<ul style="list-style-type: none"> • 50% of systems are technically appropriate for current purpose* • Basic health protection measures in place★ • 50% of wastewater systems are adequately maintained and managed★★
Quantity	<ul style="list-style-type: none"> • At least 50% of facilities such as water points, bathing areas, laundry places, slaughter areas, medical facilities, kitchens and handwashing facilities installed with appropriate wastewater disposal system
Usage	<ul style="list-style-type: none"> • 50% of wastewater disposed to designated sites

RECOMMENDED MINIMUM OBJECTIVES

Short-term	Long-term
<ul style="list-style-type: none"> • 75% of systems are technically appropriate for current purpose* • Minimal health hazard★ • 75% of wastewater systems are adequately maintained and managed★★ 	<ul style="list-style-type: none"> • 95% of systems are technically appropriate for current purpose* • No health hazard★ • 95% of wastewater systems are adequately maintained and managed★★
<ul style="list-style-type: none"> • At least 75% of facilities such as waterpoints, bathing areas, laundry places, slaughter areas, medical facilities, kitchens and handwashing facilities installed with appropriate waste water disposal system 	<ul style="list-style-type: none"> • At least 95% of facilities such as waterpoints, bathing areas, laundry places, slaughter areas, medical facilities, kitchens and handwashing facilities installed with appropriate waste water disposal system
<ul style="list-style-type: none"> • 75% of wastewater disposed to designated sites 	<ul style="list-style-type: none"> • 95% of wastewater disposed to designated sites

EMERGENCY SANITATION

Definitions of wastewater management terminology

(see Chapter 10 for further information)

***Technical appropriateness**

Wastewater management systems can be said to be appropriate if:

- the system can cope with all wastewater produced without over-flowing;
- wherever necessary grease traps have been installed and are working effectively to prevent oil or grease entering wastewater systems;
- wherever appropriate screening is provided to trap food waste;
- water, shelter, storage and sanitation facilities are not flooded or eroded by wastewater; and
- there is no standing water around facilities.

★Potential hazard to health

The potential hazard to health of wastewater can be divided into the following categories of measurement:

Major hazard: No wastewater disposal systems are in place; no easy access to sanitary facilities; high population of water-related vectors; potential water source (surface or ground) pollution from wastewater; there is standing water around facilities and slippery surfaces.

Basic health protection measures in place: Immediate drainage measures are in place but these cannot cope with the wastewater produced, so standing water still present in places.

Reduced hazard: Appropriate facilities are in place, vector population under reasonable control; minimal standing water; and community mobilisation and O&M structures are in place.

Minimal hazard: High quality facilities are in place, vector population under control; minimal standing water; and community mobilisation and well-managed O&M structures are in place.

Measures that will decrease potential hazards to health include:

- minimisation of breeding sites for vectors (e.g. mosquitoes) by ensuring that there is no standing wastewater around facilities or within the affected area;
- good drainage to ensure surfaces around sanitary facilities are not liable to erosion or slippery and dangerous; and
- appropriate drainage around shelters and latrines and other sanitation facilities to ensure that they are not in danger of flooding and to ensure constant access.

RECOMMENDED MINIMUM OBJECTIVES

★★Maintenance and management of facilities

In order to ensure the sustainability of facilities it is necessary to ensure that they are maintained and managed correctly. Appropriate measures include the following:

- The affected population does not throw any items of solid waste that might block drainage or domestic wastewater systems.
- Grease and food traps are cleaned and emptied away from wastewater systems.
- Community members dispose of domestic wastewater in designated locations.
- O&M teams and activities exist and are properly managed to ensure that systems are working effectively.

EMERGENCY SANITATION

5.7 Hygiene promotion

Table 5.6. Recommended minimum objectives for hygiene promotion

<i>Criteria</i>	<i>Immediate</i>
Quality	<ul style="list-style-type: none"> • 50% of facilitators are from the same social background as those with whom they work within the affected population and are able to communicate in the same language • 50% of facilitators (outreach workers) are trained • 50% of promotional messages are accurate, currently appropriate to the target audiences and completely cover the topic* • 50% of messages are delivered in a way that is compatible with socio-cultural aspects of affected population**
Quantity	<ul style="list-style-type: none"> • One facilitator per 1000 people • 50% of affected area covered by hygiene promotion programme • Appropriate use promoted for 50% of relevant sanitation sectors
Usage	<ul style="list-style-type: none"> • 30% of population receiving, understanding and remembering promotion messages★ • 30% of the affected population is putting programme messages into practice★★ • 30% of messages delivered are actually implemented by the population★★

RECOMMENDED MINIMUM OBJECTIVES

Short-term	Long-term
<ul style="list-style-type: none"> • 75% of facilitators are from the same social background as those with whom they work within the affected population and are able to communicate in the same language • 75% of facilitators (outreach workers) are trained • 75% of promotional messages are accurate, currently appropriate to the target audiences and completely cover the topic* • 75% of messages are delivered in a way that is compatible with socio-cultural aspects of affected population** 	<ul style="list-style-type: none"> • All facilitators are from the same social background as those with whom they work within the affected population and are able to communicate in the same language • All facilitators (outreach workers) are trained • All promotional messages are accurate, currently appropriate to the target audiences and completely cover the topic* • All messages are delivered in a way that is compatible with socio-cultural aspects of affected population**
<ul style="list-style-type: none"> • Two facilitators per 1000 people • 75% of affected area covered by hygiene promotion programme • Appropriate use promoted for 75% of relevant sanitation sectors 	<ul style="list-style-type: none"> • Two or more facilitators per 1000 people • 100% of affected area covered by hygiene promotion programme • Appropriate use promoted for all sanitation sectors
<ul style="list-style-type: none"> • 50% of population receiving, understanding and remembering promotion messages★ • 50% of the affected population is putting programme messages into practice★★ • 50% of messages delivered are actually implemented by the population★★ 	<ul style="list-style-type: none"> • 75% of population receiving, understanding and remembering promotion messages★ • 75% of the affected population is putting programme messages into practice★★ • 75% of messages delivered are actually implemented by the population★★

EMERGENCY SANITATION

Definitions of hygiene promotion terminology

(see Chapter 11 for further information)

***Accuracy and appropriateness of messages**

The accuracy and current appropriateness of messages can be determined by using the following checklist:

- Are messages factually correct?
- Are messages relevant to the current scenario?
- Are the messages simple and easy to understand?
- Are members of the affected population physically able to put messages into practice at the current time?
- Are vulnerable and gender groups (disabled, elderly, children, women and men) targeted by specific messages using appropriate media?

In addition, it is important to assess whether messages completely cover the topic tackled, and whether there are any major gaps in the information provided.

****Socio-cultural acceptability**

The socio-cultural acceptability of the messages and materials adopted in any hygiene promotion campaign is a key factor in ensuring programme effectiveness. It is important that members of the affected community are recruited and trained to be involved in campaign activities, and that their inputs are incorporated into the programme.

Through the consultation process, the facilities provided should be socio-culturally appropriate which in itself should promote their use by the population. However, an in-depth understanding of the existing social and cultural practices among the community is also essential in determining appropriate promotional methods and activities. Group discussions, poster campaigns and other media employed must be acceptable and comprehensible in order to have positive effects. For example, written messages will have little effect if many of the population are illiterate.

★Impact of messages

In order to determine whether community members are receiving, understanding and remembering hygiene promotion messages it is recommended that a series of interviews be conducted with individuals or small groups. This can be done by selecting people at random and asking a few questions.

These questions should be broad-ranging rather than specifically directed towards known hygiene promotion activities. For example:

- Are you aware of hygiene promotion activities in this area?
- Has a hygiene promoter visited you?
- Have you attended any community meetings on hygiene promotion?
- What messages have you received?
- What have you done as a result of these messages?
- Are there any problems concerning these messages?
- Do you think that the hygiene promotion activities are useful and/or important?

RECOMMENDED MINIMUM OBJECTIVES

★★Hygiene practice

The interviews described above can also provide some measure of whether the affected population is putting hygiene promotion messages into practice. In order to determine this more accurately, however, their behaviour needs to be observed. This is by no means a straightforward task, as hygiene behaviour is difficult to observe and may be affected by the observers themselves, but this can be done by using various indicators to determine whether the hygiene promotion campaign is having its desired effect:

- Are sanitation facilities being used?
- Are the facilities appropriately maintained by the community?
- Are the facilities correctly used by the community?
- Are the actions of community members adversely affecting the operation and maintenance of facilities?
- Are any existing hygiene practices unsafe? Have these been addressed by the hygiene promotion programme?
- Are community members using the hygiene equipment and materials provided?
- Are there particular sections of the community in which hygiene practices and the use of facilities are presenting problems?

These indicators should be useful in determining both the proportion of the population putting messages into practice and the proportion of messages delivered that are actually implemented by community members.

References and further reading

Ferron, Suzanne; Morgan, Joy and O'Reilly, Marion (2000) *Hygiene Promotion: From relief to development*. CARE/Intermediate Technology: UK.
The Sphere Project (1999) *Humanitarian Charter and Minimum Standards in Disaster Response*. Standing Committee for Humanitarian Response (SCHR): Geneva.
<http://www.sphereproject.org>

Chapter 6

Excreta disposal

Excreta disposal is undoubtedly one of the key elements of any emergency sanitation programme. Containment and safe disposal of human excreta is the primary barrier to transmission of excreta-related disease. Implementing agencies often focus solely on the quantity of toilets in emergency situations, however, and pay scant attention to their quality and usage.

6.1 Associated risks

6.1.1 Sources of disease

Inadequate and unsafe disposal of human faeces can lead to the contamination of ground and water sources, and can provide breeding sites for flies and mosquitoes which may carry infection. In addition, faeces may attract domestic animals and vermin which can both increase the potential for disease. It can also create an unpleasant environment in terms of odour and sight.

The introduction of safe excreta disposal can reduce the incidence of intestinal infections and helminth infestations. Excreta-related communicable diseases include cholera, typhoid, dysentery (including shigellosis), diarrhoea, hookworm, schistosomiasis and filariasis (Franceys et al., 1992). The likelihood of all these diseases, and especially epidemics such as cholera, increases significantly when a population is displaced.

6.1.2 Transmission of disease

Transmission of excreta-related diseases is largely faecal–oral or through skin penetration. Figure 6.1 illustrates the potential transmission routes for pathogens found in excreta.

Poor hygiene practice, particularly involving food and hands, may be a major cause of disease transmission, even where appropriate excreta disposal facilities are in place. For this reason it is difficult to obtain a direct correlation between the incidence of excreta-related disease and the provision of appropriate facilities.

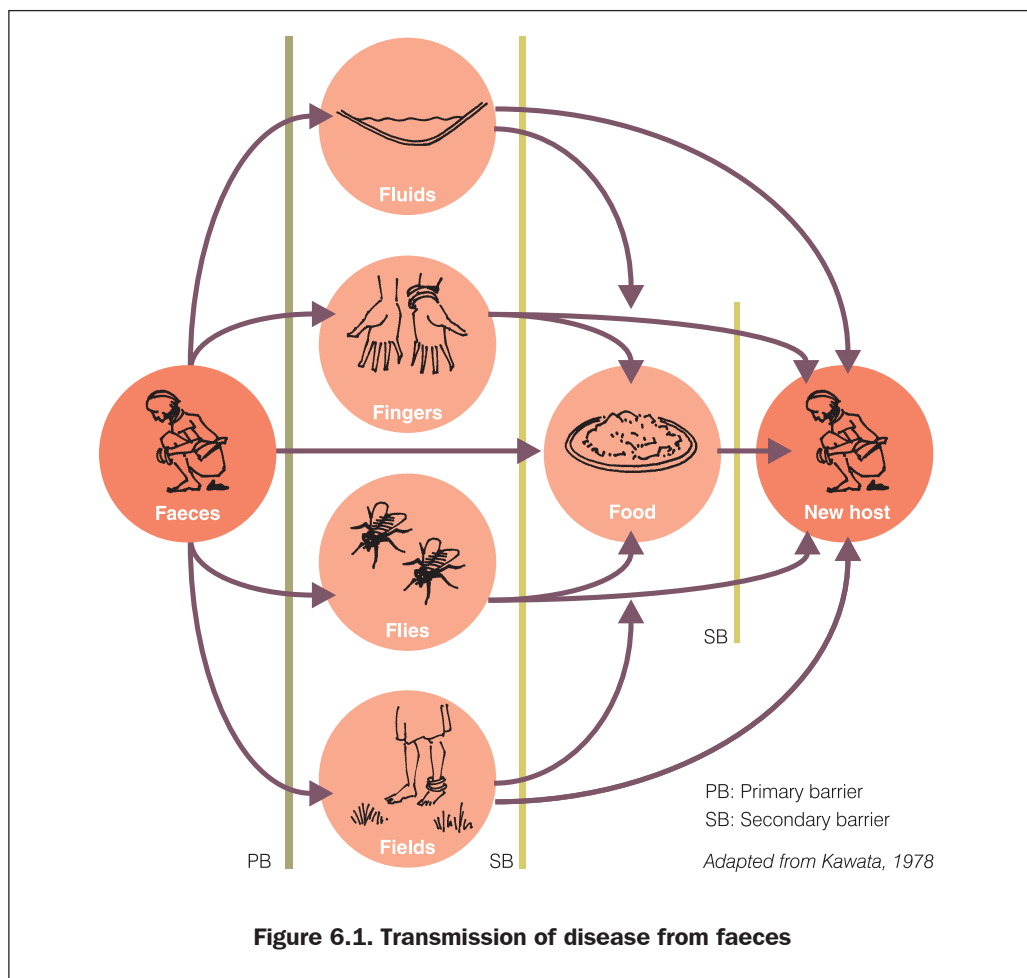

6.1.3 High-risk groups

Children under five years of age are most at risk from communicable diseases since their immune systems have not developed. Increased malnutrition, as is common in emergencies, increases this risk further. Since young children are unaware of the health risks associated with contact with faeces it is essential that faeces are safely contained.

Severely malnourished children and adults are at increased risk from diarrhoeal disease, as are elderly people especially if exhausted after travelling considerable distances.

6.2 Selection criteria for excreta disposal

In selecting appropriate excreta disposal interventions there are many criteria that must be considered. These include:

- Socio-political factors
- Socio-cultural factors
- Available space

EXCRETA DISPOSAL

- Ground conditions
- Water availability
- Anal cleansing material
- Menstruation
- User-friendliness (for children, etc.)
- Time constraints
- Design life
- Mandate of agency
- Financial constraints
- Availability of local materials
- Transportation means
- Human resources
- Operation and maintenance

6.2.1 Socio-political factors

The host country or central authorities are often reluctant to allow family units or long-term solutions to be provided for a displaced population. This is often because they do not want the affected population to feel that they are going to stay permanently in the affected area. This is generally unnecessary since people do not want to stay anyway, but where the authorities believe this, temporary communal facilities may have to be provided. If appropriate, permission for family or shared facilities should still be sought.

6.2.2 Socio-cultural aspects

The facilities provided should be as compatible as possible with the previous practices of the affected population and, where people have been displaced, also with those of the indigenous society. People are much more likely to use latrines if they are accustomed to the type of technology used. In addition, in some cultures it is unacceptable for different cultural groups to use the same latrine and this must be considered. Consultation with different groups within the affected community is essential to ascertain these factors.

6.2.3 Space

The availability of space will influence the type, design and density of latrines. For example, where space is limited family latrines may not be an option. Also, there may not be enough space to replace full pit latrines, meaning that some provision for pit emptying is required (see 6.9), or the distribution of latrines within the site may be severely limited.

6.2.4 Ground conditions

Ground conditions have a particular impact on latrines that rely on soil infiltration (such as pit latrines). The main considerations are:

- Bearing capacity of the soil (to support superstructure)
- Soil stability (to prevent pit collapse and allow excavation)
- Depth and ease of excavation possible
- Infiltration rate
- Groundwater pollution risk

See Chapter 4 for more detailed information.

6.2.5 Water availability

An important constraint in deciding on wet or dry excreta disposal systems is the availability of water in the area. Often the quantity of water available in emergency situations is severely limited. If this is the case it is likely to be inappropriate to use latrines which rely on heavy water use, such as water closets. This factor must be weighed against whether the population will use dry systems, however. Where the local custom is to use water for anal cleansing this must be also be considered.

6.2.6 Anal cleansing material

The importance of anal cleansing materials should not be underestimated. These can have a big effect on sludge accumulation rates (see 6.8.9) and water use. It is important to consider the materials the community members usually use and the materials currently available. Care should be taken to avoid making assumptions by speaking to community members and inspecting existing defecation sites to determine what materials are being used in the present situation.

6.2.7 Menstruation

Women and girls of reproductive age need access to appropriate materials for the absorption and disposal of menstrual blood. Latrines should therefore allow for the disposal of women's sanitary protection, or provide women with the necessary privacy for washing and drying sanitary protection cloths in a hygienic manner. There may also be a need to supply appropriate materials for this use.

6.2.8 Time constraints

Time is especially important in the immediate stage of an emergency, when the aim is to provide facilities rapidly in order to minimise the spread of excreta-related disease in the affected area. Possible time-constrained scenarios include:

- the sudden occurrence of a natural disaster where most infrastructure is destroyed (e.g. flood or earthquake); and
- the mass movement of an affected population to an area where there are no facilities (i.e. movement of refugees or internally displaced people).

In the above scenarios, it is likely to be appropriate to begin with the provision of simple communal facilities which can be constructed quickly. The life span of these facilities will depend on how quickly the affected population can be mobilised to construct improved family units and how long the people are likely to be displaced.

Another time constraint could be the time taken to procure equipment and materials due to the scarcity of local resources. Where this is the case, immediate emergency measures should be taken until appropriate materials can be obtained.

6.2.9 Design life

The design life of the facilities to be constructed must be considered from the onset. If the affected population is staying in a temporary camp and it is known that they will be moving within a fixed period of time, temporary facilities must be designed accordingly. Conversely,

EXCRETA DISPOSAL

if it known that the population will be staying in the area indefinitely, solutions must be designed for long-term use. Often it is not known how long a situation will last and this is a frequent cause of controversy. Latrine programmes, therefore, should be designed in such a way that they can be adapted to suit changing circumstances.

6.2.10 Mandate of agency

Some implementing agencies have a mandate to deal with the initial stages of an emergency and after that to withdraw from the affected area or hand over activities to another agency. Furthermore, if the mandate of the agency is 'direct emergency response' then a relationship has to be worked out between it and those responsible for longer term solutions, otherwise tension may be created which could adversely affect the population concerned.

It is therefore essential that all agencies should consider a long-term solution in their outline design, allowing flexibility for upgrading even if they do not have any intention of implementing these plans themselves. Such an approach will help to ensure continuity from direct response to long-term solutions.

6.2.11 Financial constraints

The financial resources available to the implementing agency may influence the choice between communal or family facilities, and the type and quality of latrine selected. For this reason it is important that a draft budget is produced in the outline programme design and that materials (including transportation) and labour are properly costed.

6.2.12 Availability of local materials and tools

If facilities can be constructed from local materials this may reduce the implementation time and cost considerably. For these reasons it is important to ascertain what resources are available and whether they can be used without adverse effect on the local environment and economy. Detailed designs that rely on high-quality imported materials may be totally inappropriate when the logistics of procuring and transporting these items is considered.

6.2.13 Human resources

The skills and experience of the available personnel may be important constraints or opportunities for selecting appropriate interventions. Complex technical designs may be inappropriate if construction personnel are unable to implement them. If staff have solid experience of particular construction techniques, however, it may be appropriate to use these, although the high turnover of staff in some situations should be considered.

6.2.14 Operation and maintenance

The operation and maintenance (O&M) of latrines should be given equal emphasis to their construction. If responsibility for O&M has to be taken by the implementing agency (i.e. the end-users will not, or cannot, clean and maintain facilities) then only communal facilities should be provided. If community members are willing to take on the responsibility for O&M, however, family latrines may be a more appropriate option.

The availability of cleaning materials, the ease of cleaning of latrine slabs or basins, and facilities for emptying pits must also be considered in latrine selection and design.

6.3 Communal or family latrines?

It is widely accepted that family excreta disposal facilities are preferable to communal facilities. Many of the factors outlined in Section 6.2 may influence this decision, however.

6.3.1 Operation and maintenance

Perhaps the most important factor concerning the choice between communal and family latrines is operation and maintenance. Field experience tends to indicate that there is a direct relationship between the ratio of facilities to the affected population and the involvement of

Table 6.1. Advantages and disadvantages of communal and family latrines (adapted from Adams, 1999)

<i>Factor</i>	<i>Communal</i>	<i>Family</i>
Speed of construction	Can be constructed fast by well-trained and well-equipped team, although rate of construction limited by number of staff and equipment.	May take considerable time to train families in the initial stages, but large numbers of latrines may be built quickly.
Technical quality	Quality of design and construction easier to control but innovative ideas from users may be missed.	Potential for innovative ideas of users, but more difficult to ensure good siting and construction.
Construction costs	Use of materials can be easily controlled but labour must be paid for.	Construction labour and some materials may be free of charge, but families may not have the time or the right skills.
Maintenance costs	Maintenance, repair and replacement costs are easier to predict and plan, but staff are required to clean and maintain facilities in long-term.	Users take responsibility for cleaning and maintenance but recurrent costs are less predictable.
Technical possibilities	Heavy equipment and specialised techniques may be used where necessary (e.g. rocky ground).	Families may not be able to dig in hard rock or build raised pit latrines where the water table is high.
Cleaning and hygiene	Users do not have to clean latrines, but these are often dirty, and a greater mix of users increases the risk of disease transmission.	Latrines are often cleaner but many users may prefer not to be responsible for construction, cleaning and maintenance.
Access and security	Latrines may be less accessible and more insecure, particularly for women.	Latrines are often more accessible (closer to dwellings) and safer.
Development issues	People may lose or not acquire the habit of looking after their own latrine.	People keep or develop the habit of managing their own latrine.

EXCRETA DISPOSAL

that population in O&M activities. Responsibility for O&M of communal latrines is often the source of tension or resentment, and as a result facilities may not be adequately maintained leading to increased health hazards.

It is also important to consider that it is possible to implement one type of facility parallel to another in such a way that they complement each other. For example, communal latrines may be provided for new arrivals at a refugee camp but after a short period of time these are replaced with family latrines.

6.3.2 Advantages and disadvantages

There are many advantages and disadvantages of both communal and family latrines. The final decision will depend on a variety of factors as outlined in Table 6.1.

6.3.3 Communal latrine scenarios

It is likely that in the following scenarios communal latrines will be the most appropriate or only option:

- Hard shelters (schools, public buildings, factory buildings, emergency centres)
- Enclosed centres (prisons, hospitals, orphanages, feeding centres, etc.)
- Difficult physical conditions (e.g. rocky ground, high water table level)
- Over-crowded peri-urban areas
- Crowded camps with little available space (population density >300 per hectare)
- Transit camps where facilities are temporary
- Where the local authorities do not permit family units

6.4 Immediate measures

Immediate measures are designed for use in the initial stage of an emergency only.

6.4.1 Clearing of scattered excreta

Where indiscriminate open defecation is practiced the first step in excreta disposal is to provide designated defecation sites and clear existing scattered faeces. This is an unpleasant task and in some cultures it may be especially difficult to find willing and suitable personnel, but it is essential to minimise the spread of faecal-oral disease. Faeces can be covered with lime and should be removed to a safe disposal site such as a pit. Workers must be provided with appropriate tools and protective clothing.

6.4.2 Controlled open field defecation

In the initial stages of an emergency, areas where people **can** defecate, rather than where they cannot, should be provided immediately. These should be located where excreta cannot contaminate the food chain or water sources. Open areas or fields surrounded by screening may be set up (Figure 6.2), with segregated sites for each sex. People should be encouraged to use one strip of land at a time and used areas must be clearly marked. It is also possible to use internal partitions to provide more privacy and encourage greater use.

EMERGENCY SANITATION

It is essential that defecation areas are:

- far from water storage and treatment facilities;
- at least 50m from water sources;
- downhill of settlements and water sources;
- far from public buildings or roads;
- not in field crops grown for human consumption; and
- far from food storage or preparation areas.

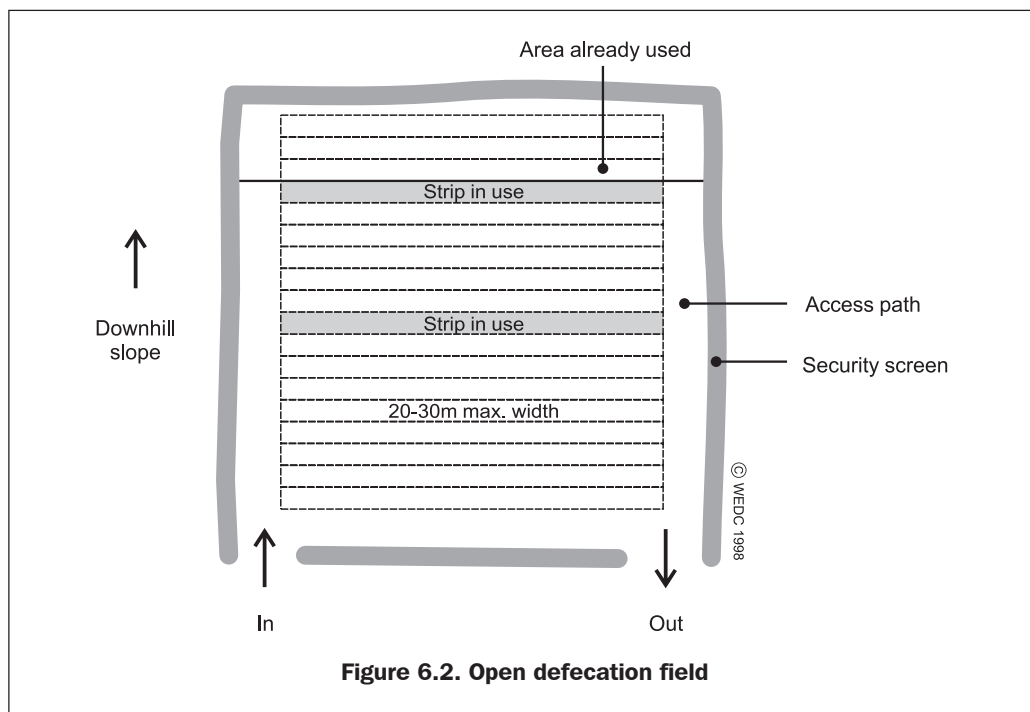

Advantages: It is rapid to implement; minimal resources are required; and it minimises indiscriminate open defecation.

Constraints: There is a lack of privacy for users; considerable space is required; it is difficult to manage; there is potential for cross-contamination of users; and it is better suited to hot dry climates.

6.4.3 Shallow trench latrines

A simple improvement on open defecation fields is to provide shallow trenches in which people can defecate (Figure 6.3). This allows users to cover faeces and improves the overall hygiene and convenience of an open defecation system. Trenches need only be 20-30cm wide and 15cm deep, and shovels may be provided to allow each user to cover their excreta with soil.

EXCRETA DISPOSAL

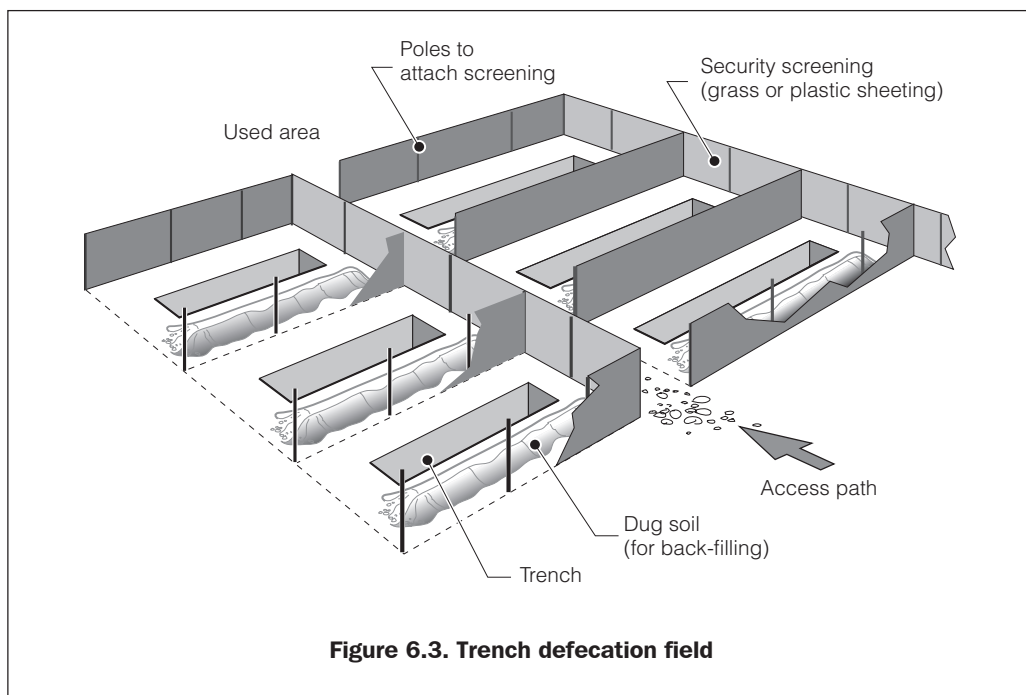

Figure 6.3. Trench defecation field

Advantages: It is rapid to implement (one worker can dig 50m of trench per day); and faeces can be covered easily with soil.

Constraints: There is limited privacy; a short life-span; and considerable space is required.

6.4.4 Deep trench latrines

Deep trench latrines are often constructed in the immediate stage of an emergency and will be appropriate if there are sufficient tools, materials and human resources available (see 6.5.3).

6.4.5 Shallow family latrines

In some situations it may be more appropriate to provide shallow family (rather than trench) latrines. This is particularly suitable where people are keen to build their own latrines or have experience of latrine construction. A shallow pit of approximately 0.3m x 0.5m and 1m deep may be excavated. Wooden foot rests or a latrine slab (approximately 0.8m x 0.6m) can be placed over this, overlapping by at least 15cm on each side. This latrine should be an immediate measure only and back-filling should occur when the pit is full to within 0.2m of the slab. A simple superstructure for privacy can be made from local materials (Figure 6.4).

Advantages: There is increased privacy; it is rapid to implement; reduced labour input is required from agency; and it allows people to actively participate in finding an appropriate solution.

Constraints: The community must be willing and able to construct family latrines; it can be difficult to manage siting and back-filling of pits; and large tools and materials required.

EMERGENCY SANITATION

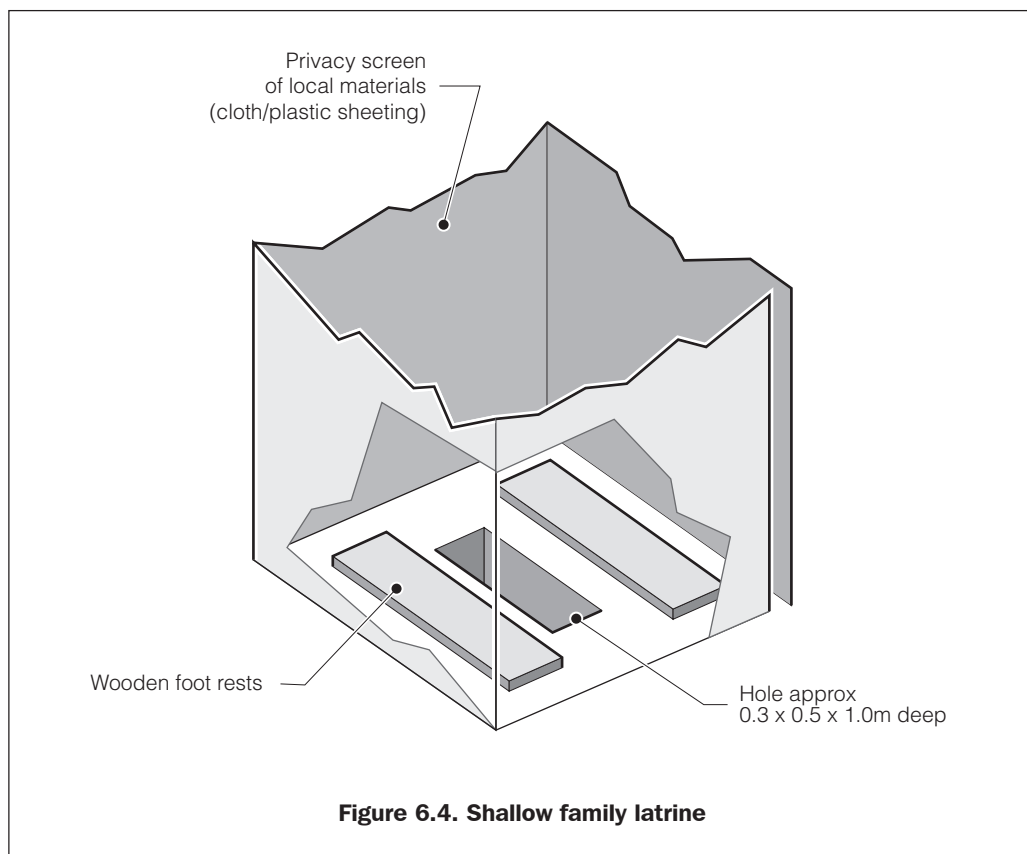

6.4.6 Bucket/container latrines

In situations where there is limited space it may be appropriate to provide buckets or containers in which people can defecate. These should have tight-fitting lids and should be emptied at least daily. Disinfectant may be added to reduce contamination risks and odour. Containers can be emptied into a sewerage system, a landfill site or waste-stabilisation ponds. This measure will only be appropriate where there are no other immediate action options and users find the method acceptable, so it is not used in most situations.

Advantages: Defecation containers can be procured easily and transported; once the containers are provided only the final disposal system need be constructed; and they can be used in flooded areas.

Constraints: Many people find the method unacceptable; large quantities of containers and disinfectant are required; extensive education regarding final disposal is required; and containers may be used for alternative purposes.

6.4.7 Storage tank latrines

In some emergency situations, such as in flooded areas or where ground excavation is difficult, large storage tanks can be situated above ground with wooden platforms and a simple superstructure fitted above. Here the user must climb steps to the latrine and the

EXCRETA DISPOSAL

effluent is collected in the tank. This is suitable as an immediate or short-term measure only and the tank is likely to require regular emptying. A suitable emptying mechanism and final disposal site are therefore needed from the onset.

Advantages: Large storage tanks are often available in relief shipments; they are rapid to construct; and they can be used on rocky ground or in flooded areas.

Constraints: Regular emptying is required; a large number of tanks may be needed which could be used for other purposes; and appropriate materials must be available to build steps and simple superstructures.

6.4.8 Packet latrines

In some emergency situations relief agencies have provided disposable packet latrines. These are plastic packets (similar in appearance to a plastic bag) in which the user can defecate. The packets contain a blend of enzymes which assists the breakdown of the excreta and must be disposed of in a safe place.

Advantages: Packets are lightweight and easy to transport; and may be used where space is severely limited or in flooded areas.

Constraints: The method may not be acceptable to affected population; and final disposal site must be clearly marked, accessible and used.

6.4.9 Chemical toilets

Chemical toilets are commonly used on a temporary basis in developed countries. These are normally single prefabricated plastic units incorporating a sit-down toilet, lockable door and effluent tank containing chemicals to aid digestion and reduce odour. They have been used in emergency situations such as the Kosova refugee crisis in 1999. In general, however, they are an expensive and unsustainable solution.

Advantages: They are hygienic; and odour is minimised.

Constraints: They are high cost; difficult to transport; and require regular emptying.

6.4.10 Repair or upgrading of existing facilities

In some emergency situations the affected community may remain or be displaced in sites where there are existing sanitation facilities. These facilities may have been damaged, however, or may be inappropriate for the changed circumstances. In such cases the repair or upgrading of these facilities is likely to be the most appropriate intervention measure, but it will depend on how quickly this can be implemented as to whether this may be an appropriate immediate measure.

Advantages: The basic infrastructure is in place to build on; and indigenous technology and materials are used.

Constraints: There are limited expansion possibilities; and repair and upgrading may take time.

6.5 Technology choice: Longer term intervention

Once it has been decided whether communal or family facilities should be provided, and what the design life of these should be, the choice of technology must be made. The selection criteria outlined in Section 6.2 should be used to make this decision.

6.5.1 Open defecation

In some emergency situations it may be perfectly acceptable for the affected population to practice open defecation. Indeed, in some cultures defecating inside a latrine superstructure is unacceptable. Where people are accustomed to open defecation it may be appropriate to continue this, providing there is adequate space and vegetation to allow people to find an appropriate defecation space so that the risk of disease transmission is minimised. Such situations can be assessed in terms of excreta disposal space rather than facilities.

Advantages: There is no cost; and no construction activities are required.

Constraints: Practice is unsuitable where people are living in overcrowded conditions; large space is needed; and this is only acceptable if the population is already accustomed to such practice.

6.5.2 Simple pit latrines

Pit latrines are by far the most common technology choice adopted in emergency scenarios. This is because they are simple, quick to construct and generally inexpensive. Figure 6.5 shows a typical simple pit latrine.

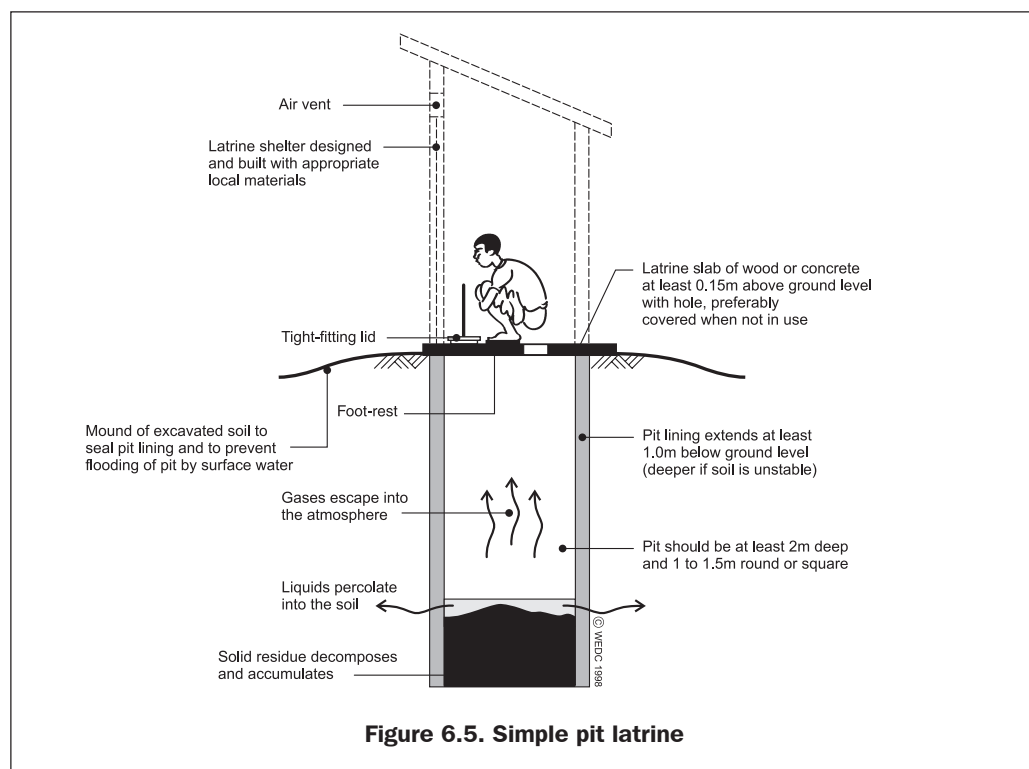

Figure 6.5. Simple pit latrine

EXCRETA DISPOSAL

The pit should be 2m or more in depth and covered by a latrine slab. The slab should be firmly supported on all sides and raised above the surrounding ground level to prevent surface water entering the pit. If the soil is unstable, the pit should be lined to prevent collapse (see 6.8.7). A squat or drophole is provided in the slab which allows excreta to fall directly into the pit. This can be covered with a removable lid to minimise flies and odour.

The superstructure can be made from materials available locally, such as wood, mud and grass, or can be a more permanent structure of bricks and mortar. The rate at which pits fill will depend on the sludge accumulation rate and the infiltration rate of the soil. Design and construction details can be found in Section 6.8.

Advantages: They are cheap; quick to construct; operate without water; and easily understood.

Constraints: They are unsuitable where the water table is high, soil is too unstable to dig or ground is very rocky; and often have odour problems.

6.5.3 Deep trench latrines

If communal latrines are to be constructed, a common option is the construction of deep trench latrines (Figure 6.6). These operate on exactly the same principle as the simple pit latrine but involve the siting of several cubicles above a single trench. Care should be taken to not put too many latrines side by side. The recommended maximum length of trench is 6m, providing six cubicles.

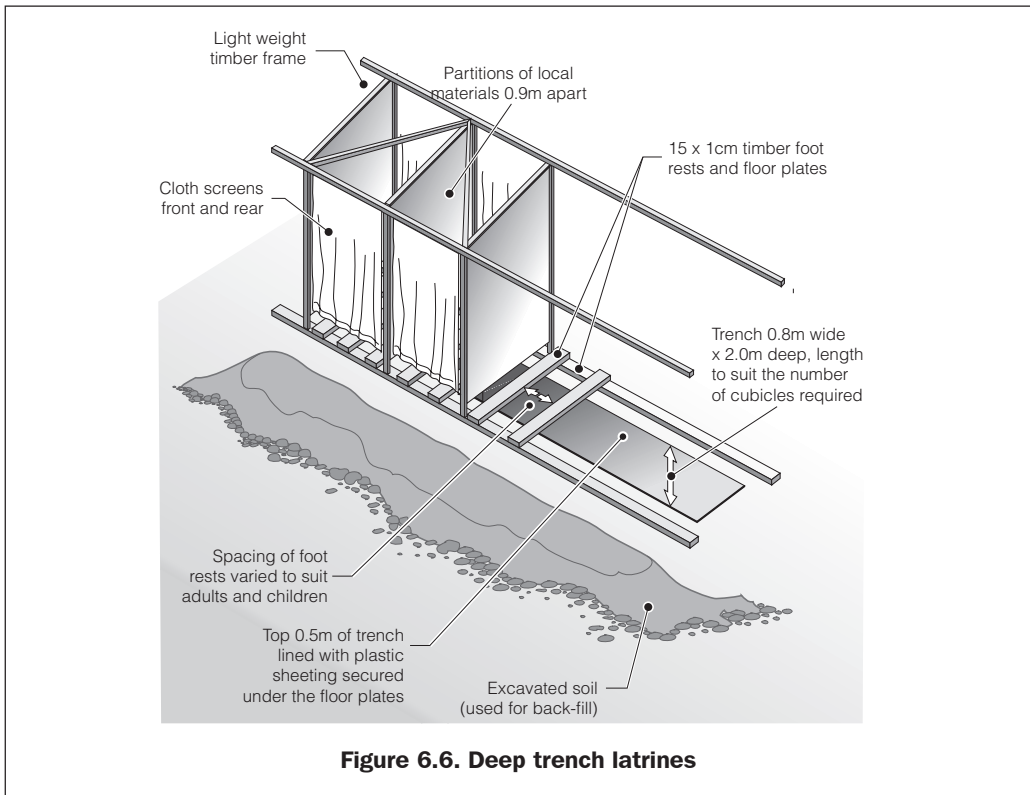

Figure 6.6. Deep trench latrines

EMERGENCY SANITATION

Trenches should be about 0.8m wide and at least the top 0.5m of the pit should be lined. Wooden platforms can be used above the trench and covered with plastic sheeting and soil. Simple wooden footrests may be used beside each drophole in the immediate stage, to be replaced with plastic or concrete latrine slabs later.

Advantages: The same advantages as simple pit latrine.

Constraints: The same constraints as simple pit latrine; and cleaning and maintenance of communal trench latrines are often poorly carried out by users.

6



Simple trench latrines, Bangladesh

6.5.4 VIP latrines

The Ventilated Improved Pit (VIP) latrine (Figure 6.7) is an improved pit latrine designed to minimise odour and flies. A vent pipe is incorporated into the design to remove odorous gases from the pit. This should ideally be situated outside the latrine interior, should extend at least 50cm above the latrine superstructure, and should be painted black to increase solar heating of the air in the vent pipe, causing it to rise (see 6.8.7 for more details). Air should be able to flow freely through the squat hole and vent pipe, therefore no drophole cover is required.

The open end of the pipe is covered with a gauze mesh or fly-proof netting which is designed to prevent flies entering the pit and to trap any flies trying to leave.

The superstructure interior should be kept reasonably dark to deter flies, but there should be a gap, usually above the door, to allow air to enter. This gap should be at least three times the cross-sectional area of the vent pipe (Franceys et al., 1992). Air flow can be increased by facing the door of the superstructure towards the prevailing wind. Each drophole should have its own compartment and there should always be **one vent pipe per compartment**.

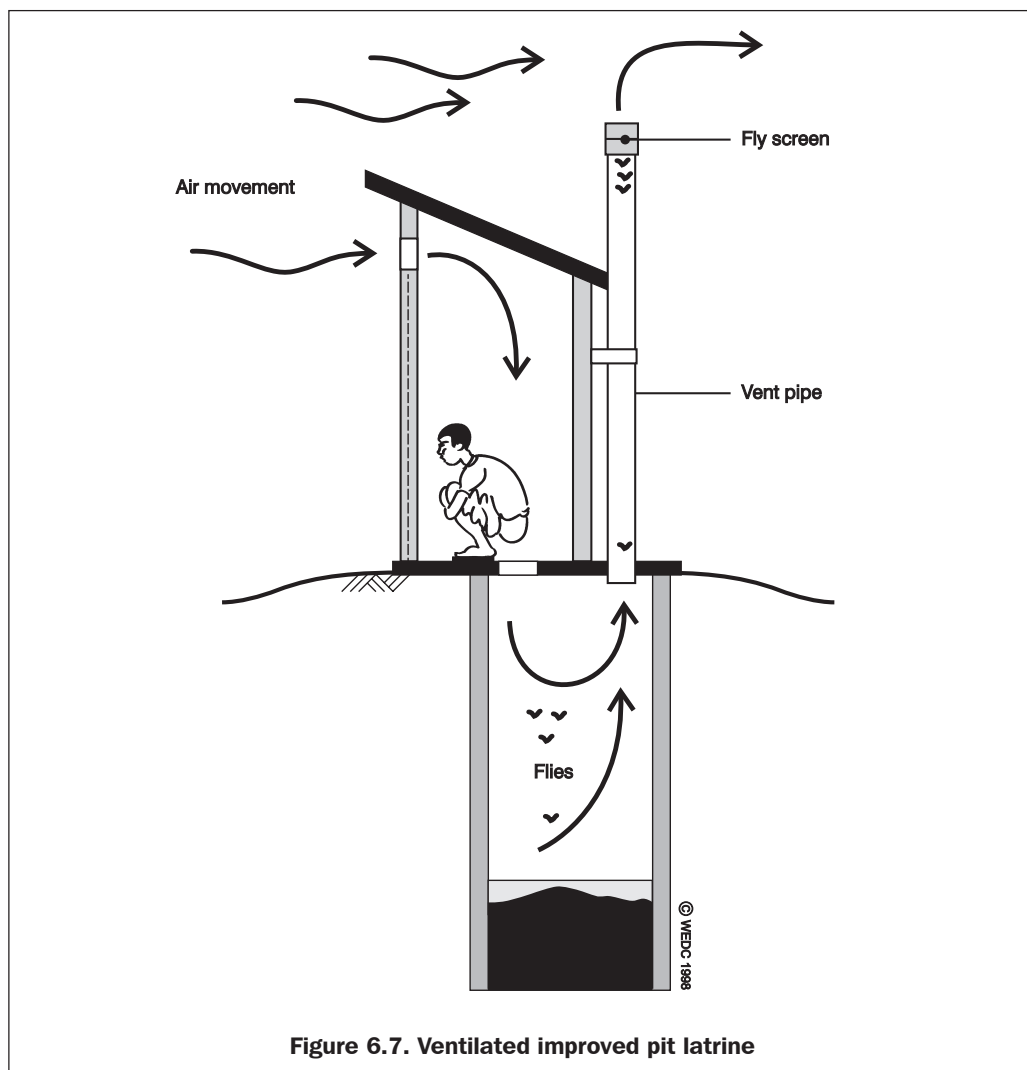

Figure 6.7. Ventilated improved pit latrine

Advantages: Odour and flies are reduced; and a good quality long-term solution.

Constraints: VIPs are difficult and expensive to construct properly; design and operation are often not fully understood; construction may take time; dark interior may deter young children from using the latrine; design does not deter mosquitoes; and there is an increased odour outside.

6.5.5 Pour-flush latrines

Pour-flush latrines rely on water to act as a hygienic seal and to help remove excreta to a wet or dry disposal system. The most simple pour-flush latrines use a latrine pan incorporating a shallow U-bend which retains the water (Figure 6.8). After defecation, a few litres of water must be poured, or thrown, into the bowl in order to flush the excreta into the pit or sewerage system below.

EMERGENCY SANITATION

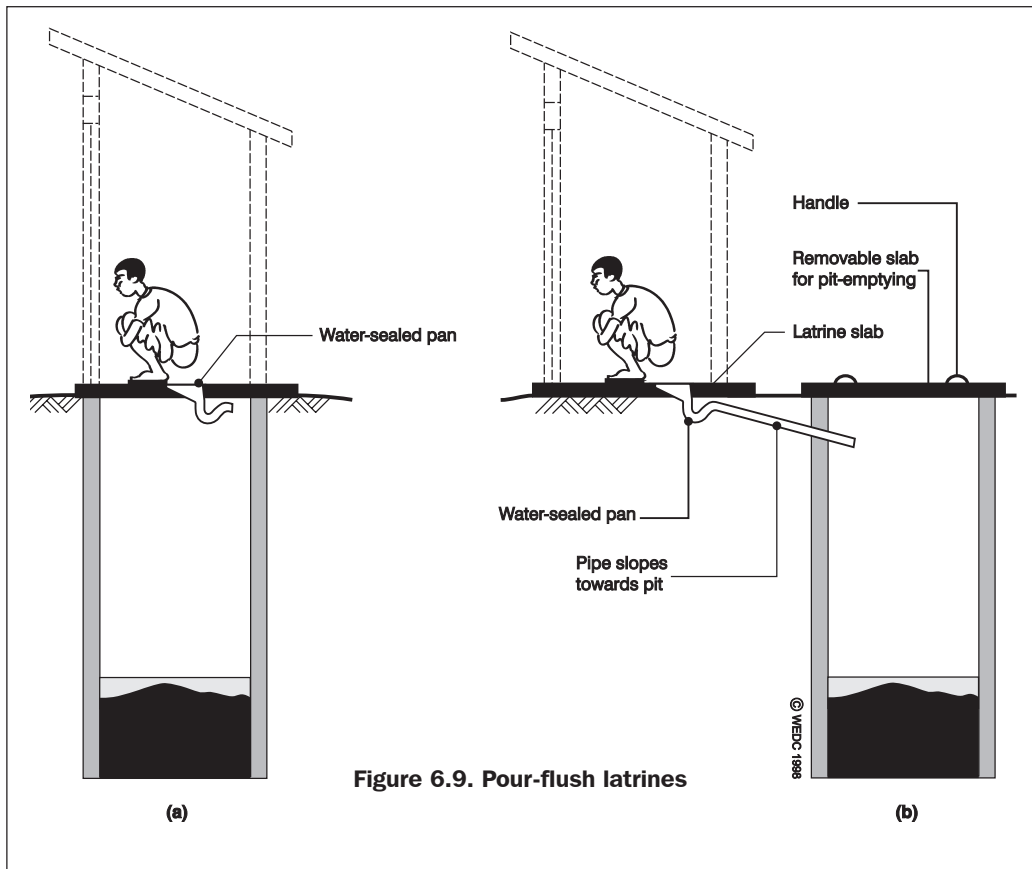
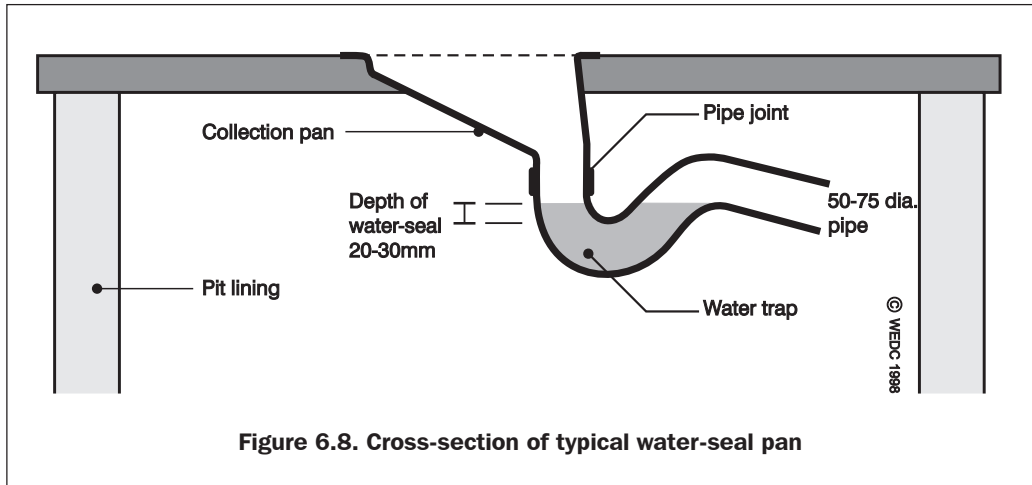

Pour-flush latrines may be constructed directly above a pit or may be offset, whereby the waste travels through a discharge pipe to a pit or septic tank (Figure 6.9).

EXCRETA DISPOSAL

Advantages: There is a lack of odour, ideal where water is used for anal cleansing; and they are easy to clean.

Constraints: An increased quantity of water required; solid anal cleansing materials may cause blockages; and they are more expensive than simple pit latrines.

6.5.6 Over-hung latrines

An over-hung latrine consists of a superstructure and floor built over water (Figure 6.10). A squat hole in the floor allows excreta to fall directly, or via a chute, into the water below. Over-hung latrines are rarely appropriate and should only be considered if other options are not possible, such as in areas prone to continued flooding. The receiving water must be sufficiently deep throughout the year, preferably should be saline to prevent human consumption, and should be flowing away from settlements.

Advantages: May be the only option in flooded areas.

Constraints: Can only be used where the contamination of the watercourse will have no adverse effect downstream; cannot be used over still water or where water is used for recreation, washing etc.; and superstructure must be solidly constructed and safe for users.

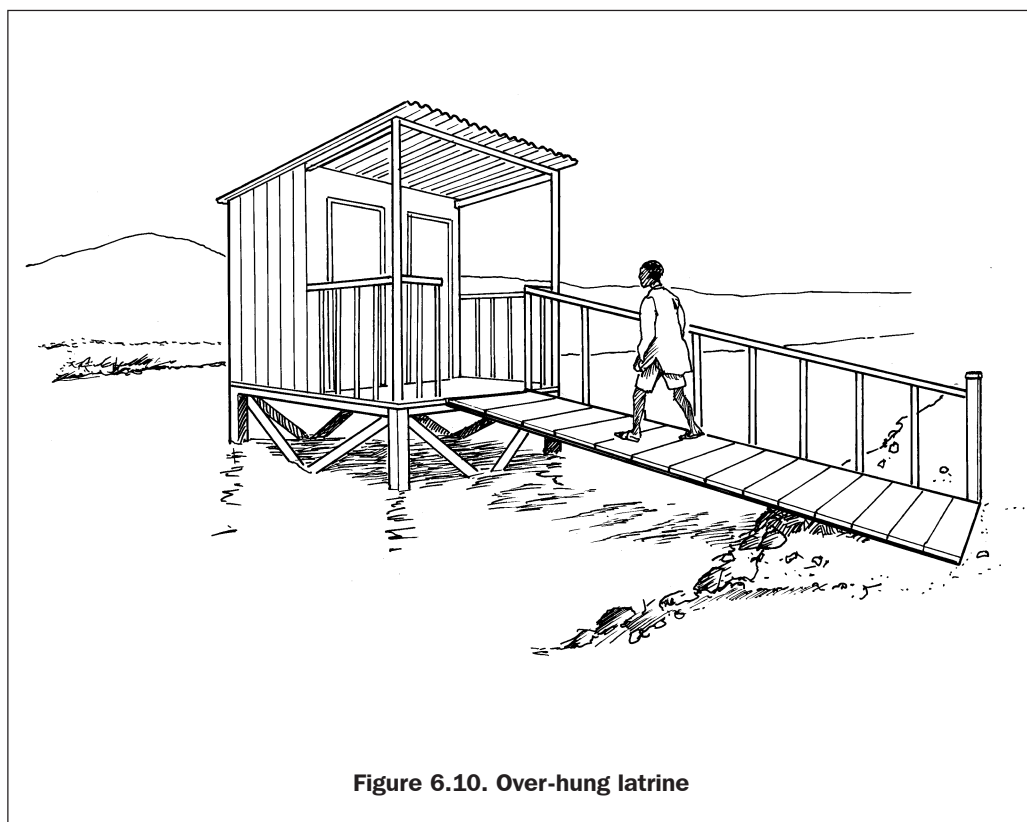

Figure 6.10. Over-hung latrine



Overhung latrine, Bangladesh

6.5.7 Borehole latrines

A borehole drilled by machine or hand-powered auger can be used as a latrine (Figure 6.11). This has a typical diameter of 400mm and a depth of 4-8m. At least the top 0.5 m should be lined although it is rarely necessary or appropriate to line the entire depth.

Borehole latrines are most appropriate in situations where boring/drilling equipment is readily available, where a large number of latrines must be constructed rapidly, and where pits are difficult to excavate, either due to ground conditions or lack of a suitable labour force.

Advantages: The borehole can be excavated quickly if boring equipment is available; suitable in hard ground conditions (where there are no large stones or rocks); and appropriate where only a small workforce is available.

Constraints: Drilling equipment is required; there is a greater risk of groundwater pollution; life span is short; sides are liable to be fouled, attracting flies; and there is a high likelihood of blockages.

EXCRETA DISPOSAL

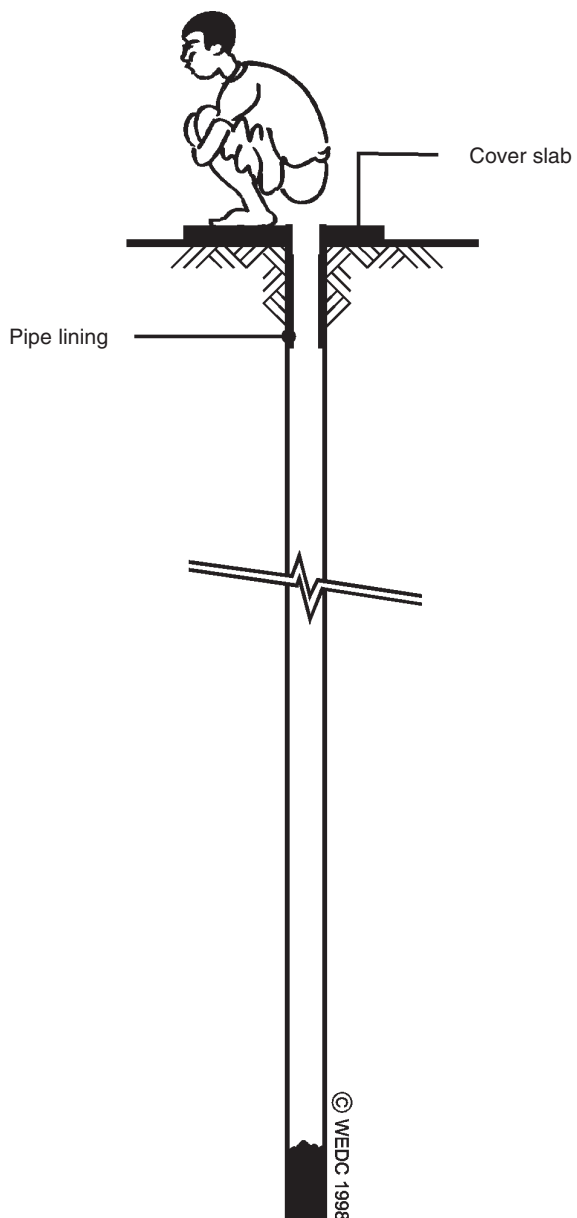

Figure 6.11. Borehole latrine

EMERGENCY SANITATION

6



Drilling boreholes for latrines, Bangladesh



Borehole latrines nearing completion, Bangladesh

EXCRETA DISPOSAL

6.5.8 Sewerage systems

In sites with existing sewerage systems it is logical to make use of this by constructing toilet blocks directly over or slightly offset from sewers (Figure 6.12). Checks should be made to ensure that the system is functioning properly and is able to cope with the increased load. An adequate quantity of water (20-40 litres per user per day) is also required for flushing.

Advantages: An existing disposal system is already in place; and system is relatively quick to implement.

Constraints: Expansion possibilities may be limited; may cause problems due to overloading of system or after the population has moved on; an adequate water supply required for flushing; and freezing may cause blockages.

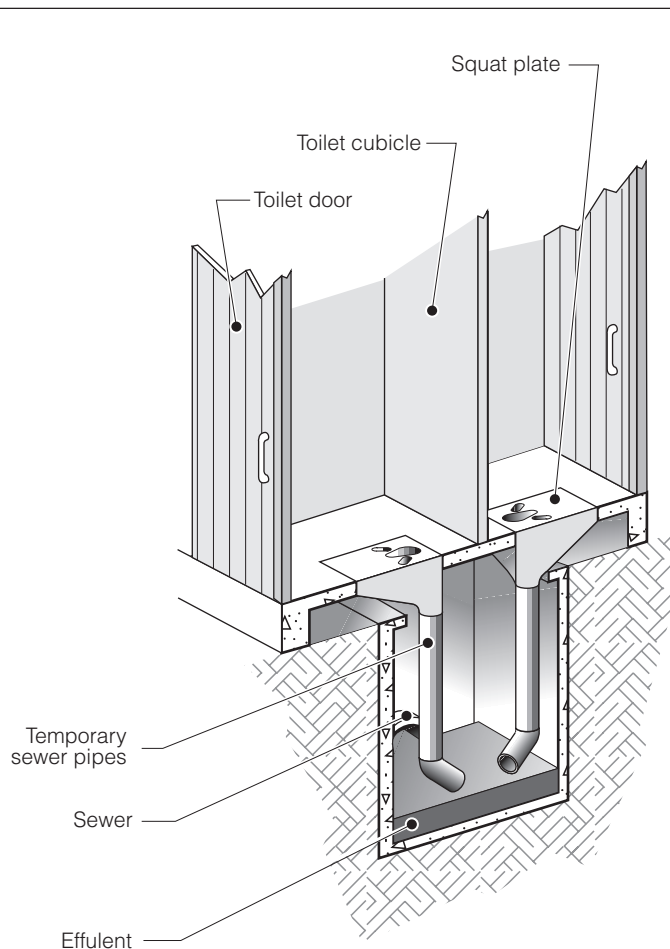

Figure 6.12. Temporary toilet block over existing sewer

6.6 Strategies for difficult conditions

In some situations it may be impossible to use traditional infiltration techniques (such as simple pit latrines) for excreta disposal. This is likely to be the case:

- where the water table is very close to the ground surface, limiting excavation;
- where groundwater sources are likely to be contaminated easily;
- where there is hard rock close to the surface, making excavation very difficult;
- where the ground is so soft that pit walls collapse before an adequate depth can be reached; and
- in flood-affected areas.

Figure 6.13 demonstrates how pollution from a latrine pit travels towards the water table. Generally, the base of the pit must be at least 1.5m above the wet season water table to prevent contamination, but in some geological conditions this may be insufficient. If there is a conflict between latrine provision and water supply it is usually easier and cheaper to develop another water source than provide alternative excreta disposal facilities. This may not always be possible, however, and wherever the groundwater level is high, protective measures should be taken, especially where groundwater is used as a source of drinking water.

If groundwater resources are not exploited for water supply in the area, the prevention of groundwater contamination should be of secondary importance to the provision of adequate excreta disposal facilities.

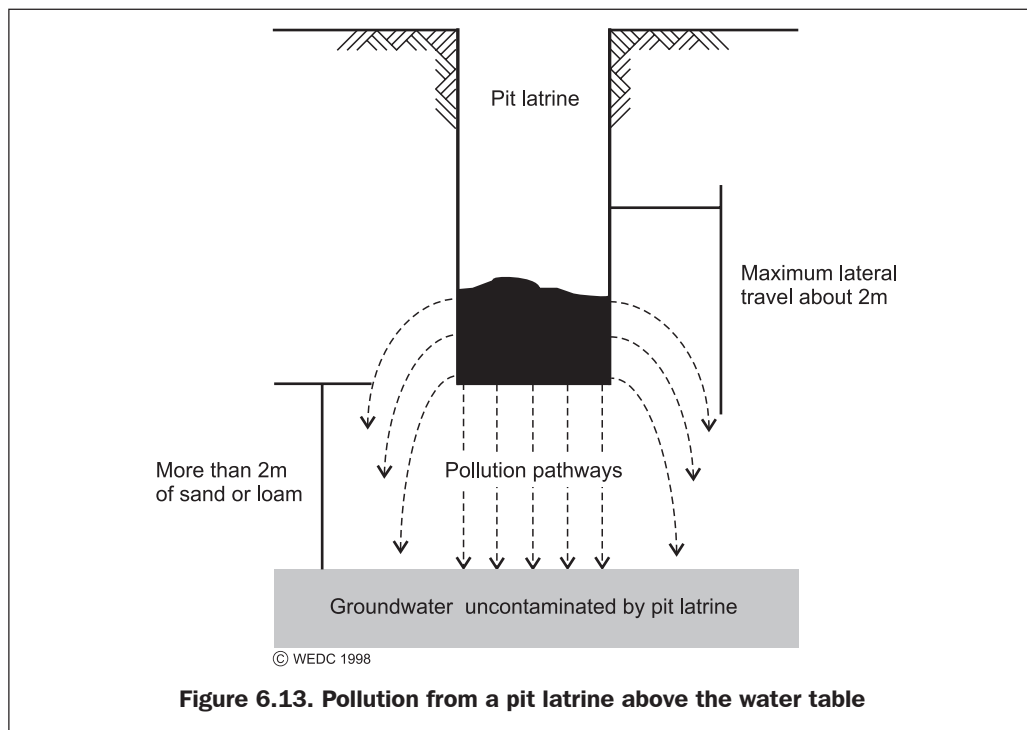

Figure 6.13. Pollution from a pit latrine above the water table



Raised VIP latrines, Tanzania

6.6.1 Raised pit latrines

Where the groundwater table is within a few metres of ground level, or excavation of the ground is extremely difficult, then a raised pit latrine may be a viable solution. This can be in the form of a simple pit latrine or a VIP latrine in which the pit is built upwards above the ground level. This increases cost and construction time considerably and family members may be unable to construct this type of latrine by themselves, but it is a relatively simple measure to minimise groundwater pollution.

6.6.2 Twin pit latrines

Where it is not feasible to dig a deep pit it may be easier and cheaper to dig two shallow pits side by side. This principle can be applied to simple pit latrines, VIP latrines or pour-flush latrines. The superstructure should be built over both pits, each of which has its own drophole. One pit is then used until it is full, at which point it is sealed and the second pit is used. If the contents of the first pit are left to stand for at least two years, virtually all of the pathogenic organisms will have died and the waste will be relatively safe to handle. Unlike a composting latrine (see 6.6.5-6), the pit contents are not a good fertiliser, although they may help to improve the quality of the soil to which they are added. Figure 6.14. illustrates a raised twin-pit VIP latrine.

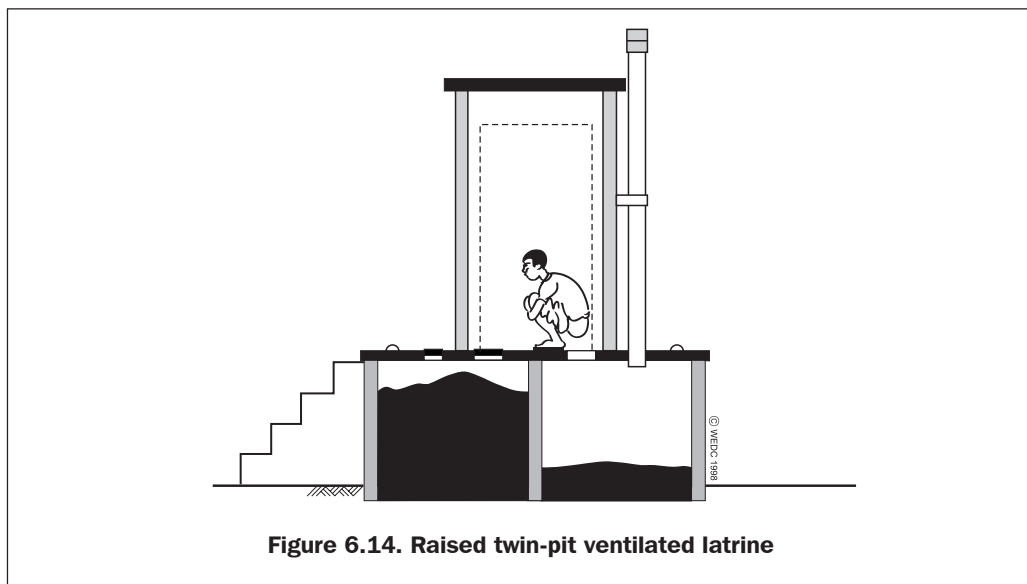

Figure 6.14. Raised twin-pit ventilated latrine

6.6.3 Sand-enveloped pit latrines

Where there is a high risk of groundwater contamination, and it is important to prevent this, a sand envelope can be constructed around a lined latrine pit to reduce pollution (Figure 6.15). This envelope is usually about 0.5m thick and acts as a filter to minimise the transmission of disease-causing micro-organisms. It should not be assumed that this will stop contamination completely. Where the risk of pollution of nearby groundwater sources is especially high, and there is no viable alternative, it may be appropriate to construct sand-enveloped raised pit latrines.

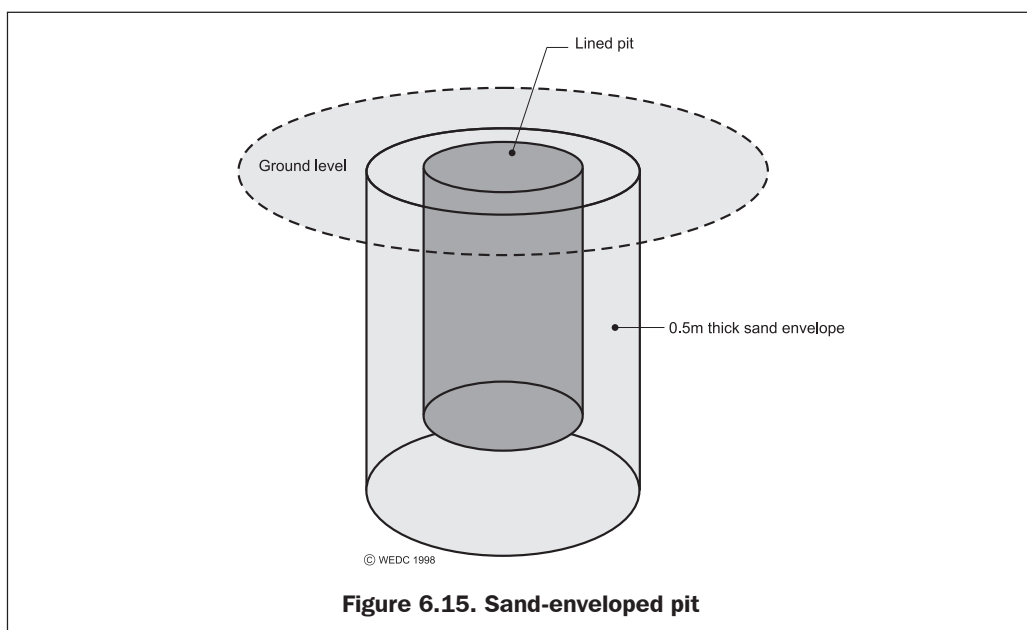

Figure 6.15. Sand-enveloped pit

EXCRETA DISPOSAL

6.6.4 Sealed pits/tanks

Groundwater contamination can also be prevented if the disposal pit or tank is fully lined and sealed, so that the contents are unable to infiltrate into the surrounding ground. The construction of fully lined pits is expensive and time-consuming, however, and is likely to be impractical where family latrines are desired. The second disadvantage is that such pits will need to be emptied relatively regularly, since no infiltration is able to occur.

6.6.5 Anaerobic composting latrines

Anaerobic composting latrines use a dry disposal system in which urine and faeces are managed separately. The deposited faecal matter is dried by exposure to heat or the sun and the addition of lime, ash, sawdust or earth, which controls the moisture content. Vegetable or other organic waste can also be added to control the chemical balance. The latrine contents are then isolated from human contact for a specified period to reduce the presence of pathogens and make the waste safe for handling. This period should be at least ten months and some practitioners recommend longer periods of two years or more. The longer the waste is stored the more pathogens will be destroyed. The waste may then be re-used as fertiliser or as fuel.

The primary difficulty in using this type of toilet is the separation of urine and faeces. Users have to be made aware of the importance of separation and the addition of ash after defecation. Such a system is unlikely to work where water is used for anal cleansing since this will increase the moisture content. This type of latrine is rarely appropriate in the initial stages of an emergency, unless the population is already accustomed to using similar systems. It requires no water and can be adopted where infiltration techniques are impossible, however, and may be a viable longer term option.

Figure 6.16 illustrates a double-vault latrine where one vault is used initially then sealed when full. The second vault is then used until that is full, at which point the first vault can be emptied and re-used. The vault size must be carefully calculated to ensure that the waste is retained for an appropriate period of time (see 6.8.8).

Heavy usage — as is likely in many emergency situations — may lead to serious problems because of inadequate time for decomposition.

EMERGENCY SANITATION

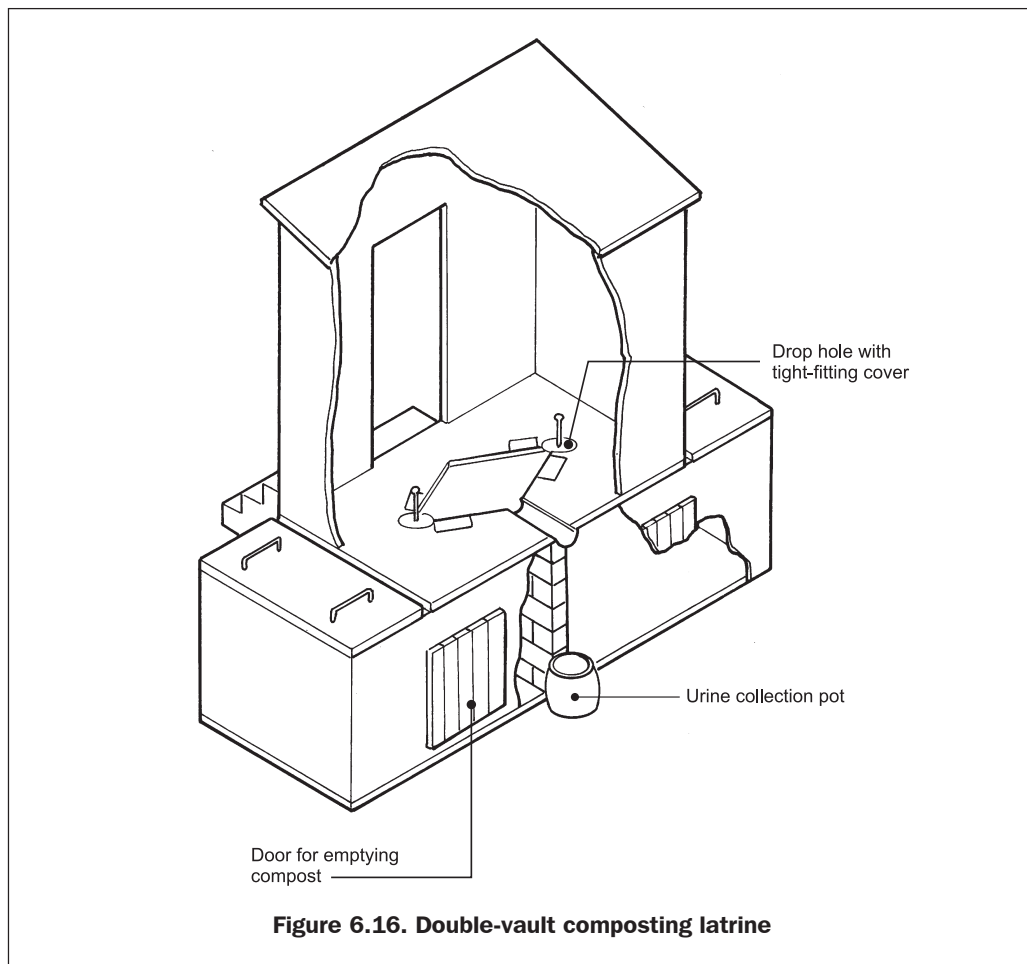

6.6.6 Aerobic composting latrines

Aerobic composting latrines use a similar method to the anaerobic composting latrine and the intended outcome is the same — to reduce excreta to a safe re-usable state. The main difference is that urine does not need to be separated from faecal matter. New wastes must be separated from old, however, and air must be able to circulate freely. In a composting latrine, bacteria, worms, or other organisms are used to break down organic matter to produce compost. This is encouraged through the addition of organic refuse, such as vegetable waste, to the toilet chamber. The final compost produced can then be used as fertiliser for agricultural purposes.

Continuous composting toilets are expensive to construct and have only proved successful in small communities in industrialised countries. Like all composting latrines, this type of disposal system requires considerable user awareness and understanding, and is most appropriate where the affected population has some experience of this type of technology. In general, it is not an appropriate emergency excreta disposal system.

EXCRETA DISPOSAL

6.6.7 Septic tanks

A septic tank is designed to collect and treat toilet wastewater and other grey water (Figure 6.17). Its use is likely to be appropriate where the volume of wastewater produced is too large for disposal in pit latrines, and water-borne sewerage is uneconomic or unaffordable. Septic tanks are therefore particularly suited to systems involving high water use, especially where water is used for anal cleansing.

Wastes from toilets, and sometimes kitchens and bathrooms, pass through pipes to a water-tight tank where they are partially treated. After one to three days the liquid wastes leave the tank and are carried to a secondary treatment system. This is usually some form of underground disposal system, sewer or secondary treatment facility.

The treatment process in a septic tank occurs in four stages:

Settlement: Heavy solids settle to the base of the tank to form a sludge which must occasionally be removed; about 80 per cent of the suspended solids can be separated from the liquid in a well-designed tank.

Flotation: Grease and oil float to the surface to form a layer of scum; over time this scum layer becomes thick and the surface may be hard.

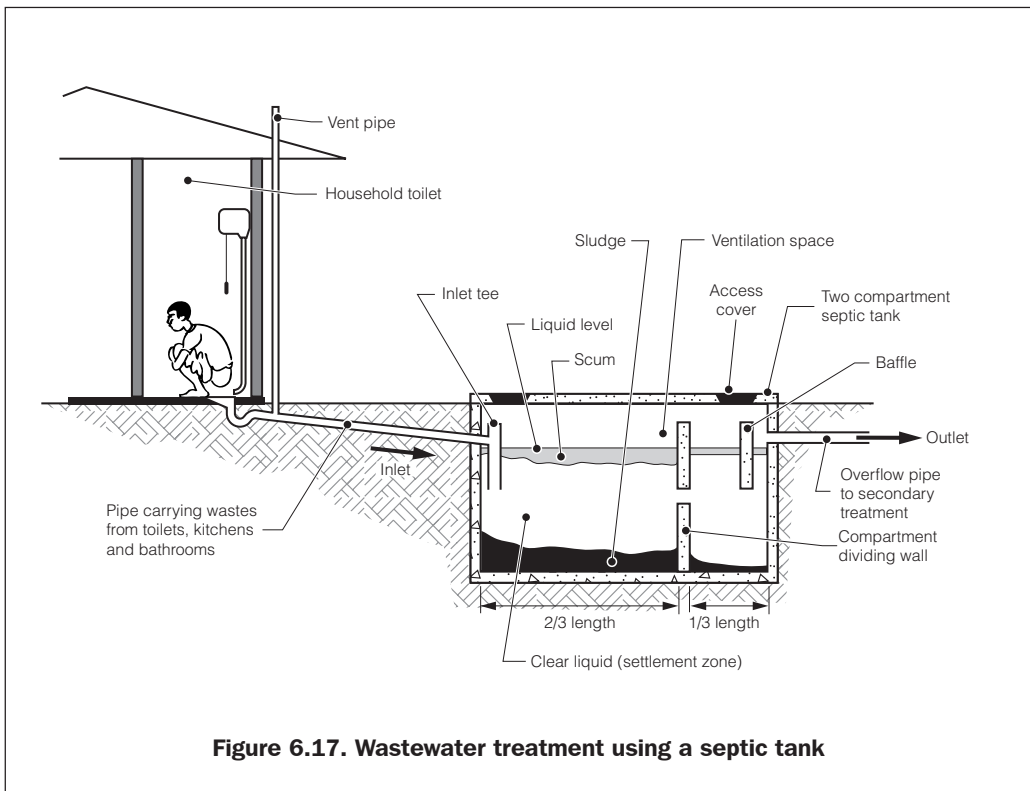

Figure 6.17. Wastewater treatment using a septic tank

EMERGENCY SANITATION

Sludge digestion and consolidation: The sludge at the bottom of the tank is compressed by the weight of new material settling on top, increasing its density; and organic matter in the sludge and scum layers is broken down by bacteria which convert it to liquid and gas.

Stabilisation: The liquid in the tank undergoes some natural purification but the process is not complete; the final effluent is anaerobic and will contain pathogenic organisms such as roundworm and hookworm eggs.

The final effluent leaving the septic tank must be disposed of in an appropriate location such as a sealed pit or sewerage system.

6.6.8 Aqua privies

An aqua privy (Figure 6.18) is simply a latrine constructed directly above a septic tank. Aqua privies are appropriate where pit latrines are socially or technically unacceptable but the volume of sullage is small. The amount of water required for flushing is much smaller than for a septic tank because of the location of the tank. The water-seal pan and extension of the drop pipe 75mm below the water surface helps to exclude odours from the superstructure. The tank of the aqua privy must be watertight to maintain a constant liquid level in the tank. The outlet pipe should extend at least 50mm below the water surface to provide an odour seal.



Communal aqua privy, Bangladesh

EXCRETA DISPOSAL

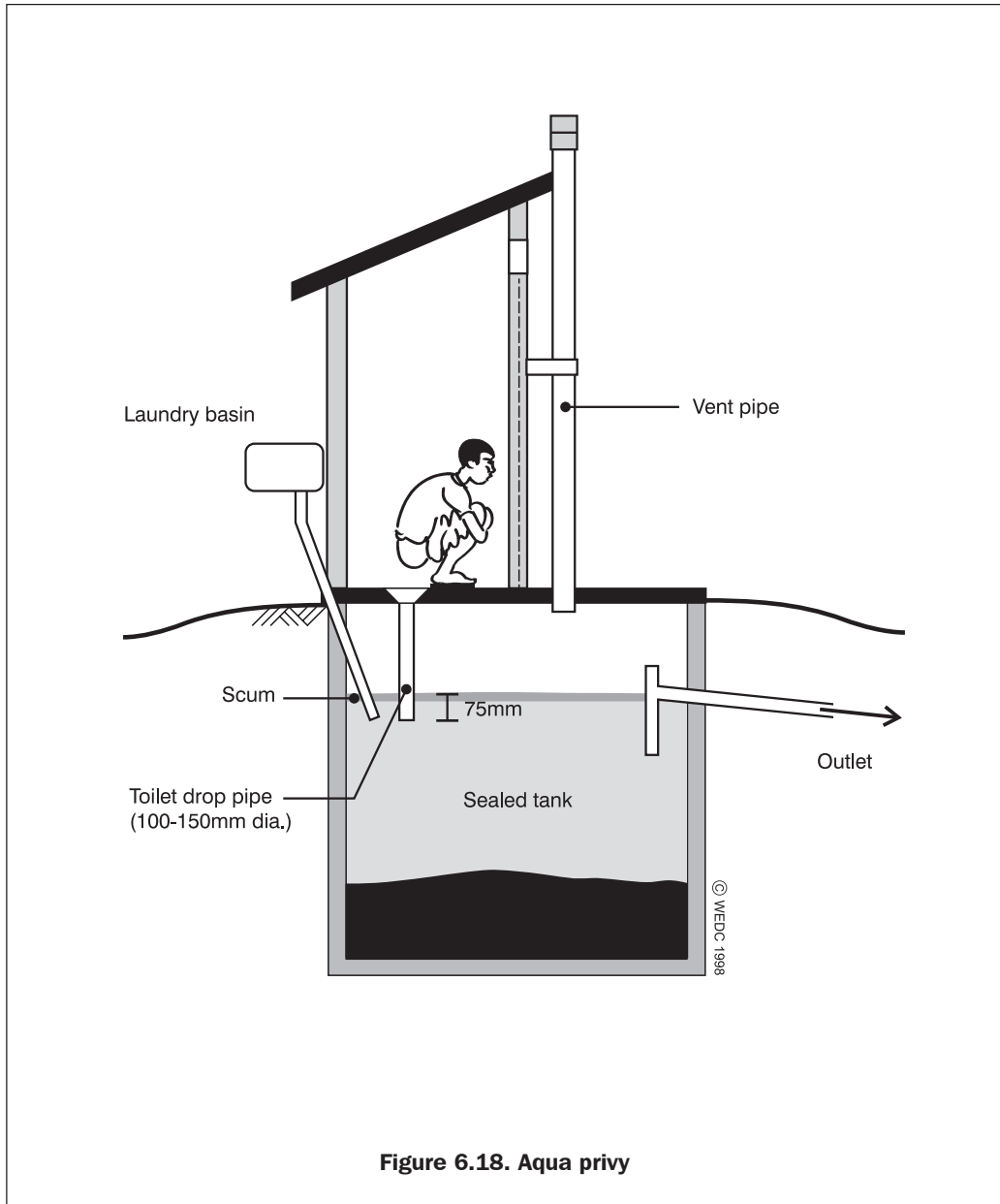

Figure 6.18. Aqua privy

6.6.9 Sewerage systems

Sewerage systems are not common in emergency situations, although they may be used where the affected population remains or relocates in an urban area. Most sewerage systems need at least 20-40 litres of water per user per day to be flushed into the system (Adams, 1999). In addition, pumped sewerage systems and sewage treatment works may require a back-up power supply to keep the system running. This may be a major undertaking.

6.7 Intervention levels

The selection of appropriate actions depends primarily on the actual scenario and the intervention level required. The following tables (6.2-6.4) indicate the most appropriate general options for immediate, short-term and long-term measures for four different scenarios, depending on the amount of space available.

Table 6.2. Recommended interventions for space of more than 30m² per person

<i>Scenarios and recommended interventions</i>	<i>The affected population go through a transit camp immediately after a disaster</i>	<i>The affected population remain in a temporary location for up to six months</i>	<i>The affected population stay in the affected area immediately after a disaster</i>	<i>The affected population move to a new area and are likely to remain for more than a year</i>
Immediate action	<ul style="list-style-type: none"> ■ Clearing of scattered faeces ■ Controlled open defecation ■ Shallow trench latrines ■ Repair of existing facilities ■ Temporary communal or family latrines 			
Short-term measure	<ul style="list-style-type: none"> ■ Semi-permanent family latrines ■ Semi-permanent shared latrines 			
Long-term measure			<ul style="list-style-type: none"> ■ Permanent family latrines ■ Upgrading of existing facilities 	

*Total available space (including space for non-dwelling areas)

EXCRETA DISPOSAL

Table 6.3. Recommended interventions for space of 20-30m² per person

Scenarios and recommended interventions	<i>The affected population go through a transit camp immediately after a disaster</i>	<i>The affected population remain in a temporary location for up to six months</i>	<i>The affected population stay in the affected area immediately after a disaster</i>	<i>The affected population move to a new area and are likely to remain for more than a year</i>
Immediate action	The same as Table 6.2			
Short-term measure	<ul style="list-style-type: none"> ■ Semi-permanent communal latrines ■ Semi-permanent shared latrines 			
Long-term measure			<ul style="list-style-type: none"> ■ Permanent shared or communal latrines ■ Upgrading of existing facilities 	

Table 6.4. Recommended interventions for space of less than 20m² per person

Scenarios and recommended interventions	<i>The affected population go through a transit camp immediately after a disaster</i>	<i>The affected population remain in a temporary location for up to six months</i>	<i>The affected population stay in the affected area immediately after a disaster</i>	<i>The affected population move to a new area and are likely to remain for more than a year</i>
Immediate action	The same as Table 6.2			
Medium-term measure	<ul style="list-style-type: none"> ■ Semi-permanent communal latrines 			
Long-term measure			<ul style="list-style-type: none"> ■ Permanent communal latrines ■ Upgrading of exciting facilities 	

These options are not exhaustive but provide an outline of the main actions to be considered in each scenario.

6.8 Design and construction

In the design and construction of any latrine it is important to consider the following four key factors:

- Safety
- Comfort
- Privacy
- Health

6.8.1 Siting latrines

Perhaps the most important design factor regarding latrine construction is **where** the latrine should be sited. The following factors are important siting selection criteria; each latrine constructed should be:

- not more than 50m away from dwellings to be served;
- at least 30m away from water storage and treatment facilities;
- at least 30m away from surface water sources;
- at least 30m horizontal distance from shallow groundwater sources (more in coarse or fissured ground);
- downhill of settlements and water sources, where possible;
- at least 50m away from communal food storage and preparation areas;
- close to handwashing facilities; and
- easily accessible to all intended users including children, old people, pregnant women and disabled people.

Accessibility is a key issue since this is likely to influence how often latrines are used, and hence whether indiscriminate defecation takes place or not. Security of users, especially women and children, must also be considered, particularly where communal latrines are in place. If necessary, facilities can be lit at night for security and convenience.

6.8.2 Construction materials and tools

The single most important factor in the selection of construction materials and tools is local availability. It is inefficient and inappropriate to import expensive materials if suitable materials are available locally. Possible construction materials include:

- Wood
- Grass
- Mud
- Earth blocks
- Bamboo
- Leaves
- Bricks
- Cement
- Gravel
- Sand
- Corrugated iron sheeting
- Plastic sheeting
- Cloth or sacking

EXCRETA DISPOSAL

There is often a tendency to focus on the use of typical relief agency materials, such as plastic sheeting, when there may be much better local alternatives available. Tools are often available locally, and although these may sometimes be of lower quality than imported ones, they are likely to be much more cost-effective, and the local population will be more accustomed to their use. Heavy equipment, or specialised equipment, may also be available and this may influence the selected construction method as well as the overall technology choice.

6.8.3 Superstructure design

To the user, the superstructure is likely to be the most important part of the latrine. For this reason alone, due attention must be given to its design. In some cultures people prefer to defecate in the open and a superstructure may not be required. In general, however, the superstructure must provide the necessary privacy for the comfort and dignity of the users. Materials and techniques used for the superstructure should generally be the same as those used for people's shelters, as this will facilitate ease of construction.

In areas of high rainfall, or for VIP latrines, a roof will be essential, although roofing materials may be stolen where shelter is a priority. In other situations roofs may not be necessary. The superstructure may have a door where desired, or a spiral-shaped entrance can be constructed. The superstructure can, more or less, be of any size and shape that the user desires, although a minimum base area of 1m² is recommended.

Although the superstructure has little direct impact on the health benefits of the latrine (with the possible exception of a VIP latrine), its design is likely to influence whether the latrine will be used and looked after. It is therefore essential that the users are involved in the superstructure design, to ensure that it is socio-culturally acceptable and to promote the users' pride in their toilet.

6.8.4 Latrine slabs

An important component of a pit latrine is the latrine slab situated above the pit. The purpose of the latrine slab is to cover the top of the pit and, sometimes, to provide a surface on which the user puts their feet. The slab should be able to support the weight of a person, be easy to clean, and should be sloped slightly towards the squat-hole to allow liquid to drain. Figure 6.19 shows a typical cross-section of a latrine slab.

EMERGENCY SANITATION

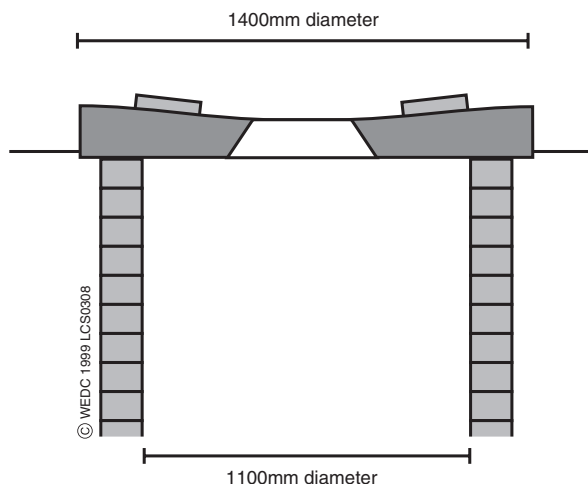

Figure 6.19. Cross-section of latrine slab with footrests

In many cases, the slab is likely to be the most expensive component of a simple pit latrine, since its production may entail skilled labour, cement, gravel and reinforcement.

In the early stages of an emergency, many agencies use pre-moulded plastic squatting plates. These are appropriate for immediate rapid implementation and are often suitable for use in emergency trench latrines, health centres, schools and reception centres. However, for long-term use it is more efficient to use locally manufactured slabs where possible.

The squat-hole in the latrine slab should be large enough to allow defecation and urination without fouling the floor, whilst being small enough for the young and old to span in safety. Ideally, this should be a 'keyhole' shape, about 160mm in diameter and 250mm long.

Slabs can be made of concrete, wood, ferrocement or plastic. Concrete is currently the preferred material since it is cheap, durable, easy to clean and simple to manufacture. Most concrete slabs are reinforced with steel bars to prevent breaking (Figure 6.20), and reinforcing bars should be placed near the base of the slab to carry the tension forces.

EXCRETA DISPOSAL

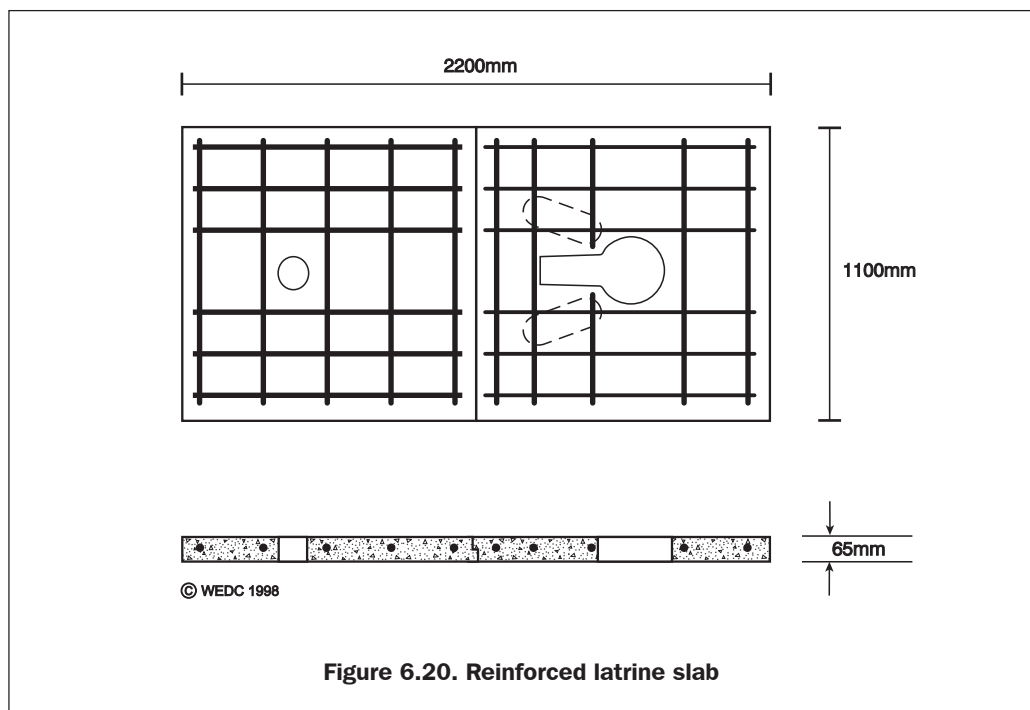

The amount of reinforcement will depend on the size of the slab and the load to be carried. Table 6.5 gives suggestions for the amount of reinforcement required for different slabs. Slabs may be rectangular or circular.

Table 6.5. Spacing for steel reinforcing bars in pit latrine slabs						
Slab thickness (mm)	Steel bar diameter (mm)	Spacing of steel bars (mm) in each direction for minimum spans of:				
		1m	1.25m	1.5m	1.75m	2m
65	6	150	150	125	75	50
65	8	250	250	200	150	125
80	6	150	150	150	125	75
80	8	250	250	250	200	150

Slabs without reinforcement can be made provided the slab is domed (Figure 6.21). The dome shape causes all the forces in the slab (apart from the rim) to be compressed so reinforcement is not needed. Domed slabs are cheaper than reinforced slabs but more care is required in their manufacture and transport. Such slabs have a typical diameter of 1.2-1.5m.

EMERGENCY SANITATION

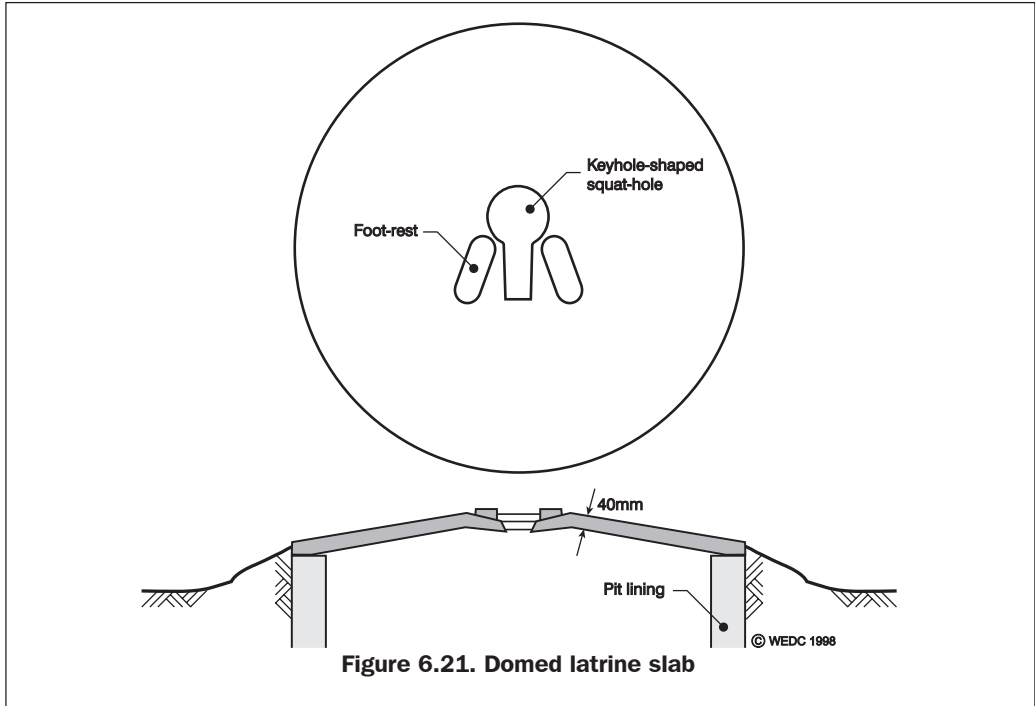

Wooden slabs can also be used where concrete is too expensive or is unavailable. Wooden slabs can consist of whole poles covered in mud or soil (Figure 6.22), or can be sawn-timber platforms.

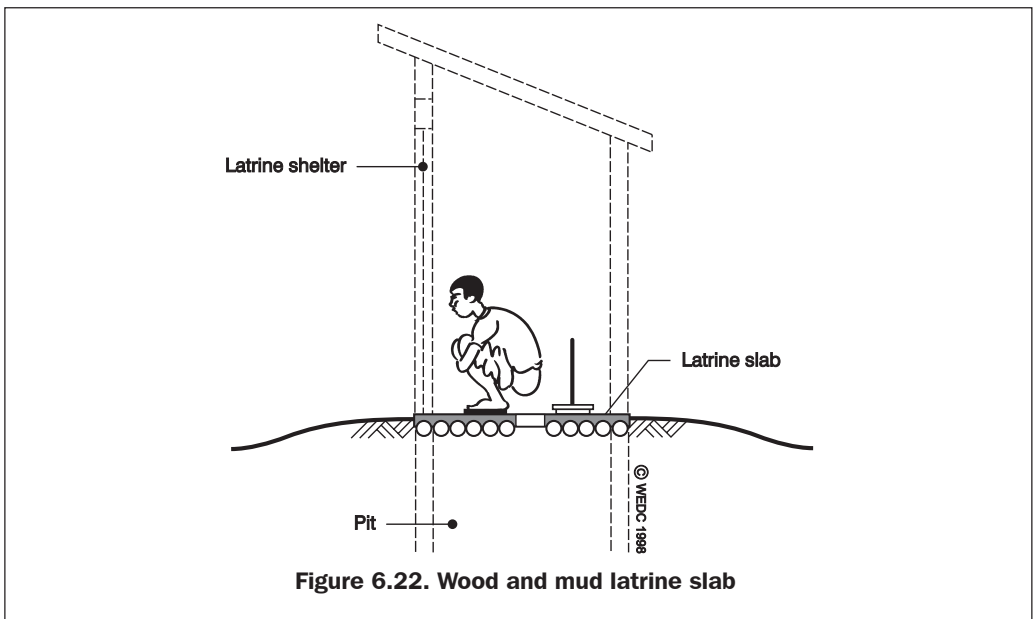

EXCRETA DISPOSAL

Pits with wooden slabs can be improved by placing a small concrete slab (San-plat) on top to cover the area used for defecation. The slab is quite small (typically 400mm x 600mm) but it covers the area of slab most likely to be fouled.

6.8.5 Making concrete

Concrete is a mix of cement, sand, gravel (aggregate) and water. Generally one of the two following design mixes is used:

Cement	Sand	Aggregate	
1	2	4	<i>Mix 1</i>
1	3	6	<i>Mix 2</i>

Mix 1 will be slightly stronger than Mix 2 due to the increased proportion of cement. In both cases gravel makes up approximately 60 per cent of the volume of concrete. The ratio of water to cement is generally:

Water	Cement
1	2 <i>or</i>
1	3

Concrete should be mixed on a clean, level mixing area. The following process should be adopted:

1. Measure out appropriate volumes of cement, sand and aggregate (according to the mix ratios above).
2. Shovel half the aggregate onto the mixing area.
3. Add half the sand.
4. Add half the cement.
5. Add the remaining sand.
6. Add the remaining cement.
7. Add the remaining aggregate.
8. Form a 'well' in the middle of the mix and add a small amount of water.
9. Mix the constituents together.
10. Continue adding water and mixing until uniform consistency is obtained.

Once the concrete is poured into the mould it must be **compacted** to eliminate voids (air holes). This can be done manually by using a wooden plank to pound the concrete surface.

The final stage of concrete preparation is **curing**, which simply means keeping the concrete damp while it sets. Concrete can be cured by covering, regular spraying or submerging in water.

The strength and workability of concrete is affected by the:

- concrete mix;
- water/cement ratio; and
- the curing process.

6.8.6 Squat-hole covers

The squat-hole cover for a simple pit latrine is designed to cover the hole when not in use, and to minimise flies and odour. A common problem concerning these covers is that they are often not replaced on the hole after use. This may be due to worries of faecal–hand contamination, or may be because covers are taken away for alternative uses.

In some cases, the cover is designed with a long handle, or is tied with a piece of string to the surrounding superstructure. An alternative design for a squat-hole cover is illustrated in Figure 6.23. Here, a hinged cover is used which can be opened and closed with the use of an attached piece of string, by hand, or even with the user's foot. The hinges can be made from old tyre rubber, which is available in most situations. The rubber hinges can be attached to the reinforcement within a concrete latrine slab, or tied to the wooden poles of a wooden slab.

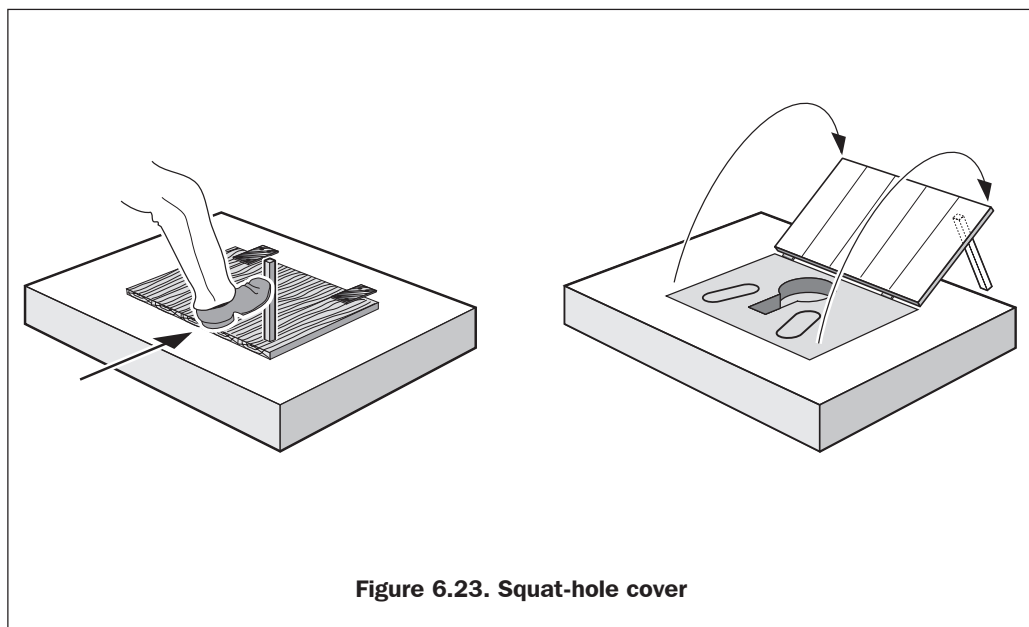

Figure 6.23. Squat-hole cover

6.8.7 Ventilation pipes

For VIP latrines it is important that the ventilation pipe is properly designed. A wide variety of materials can be used, such as uPVC, asbestos cement, fired clay, concrete or even mud covered bamboo or reed. If the pipe is smooth inside (such as plastic or asbestos cement) then an internal diameter of 150mm should be sufficient. Otherwise vent pipes should be at least 200mm diameter or square. The pipe should extend at least 0.5m above the superstructure roof to ensure the air flow is unobstructed.

The fly screen on top of the ventilation pipe should be made of mesh of about 1.2-1.5mm spacing. Mosquito netting is often used. The gases given off by the decomposition of excreta

EXCRETA DISPOSAL

are very corrosive. For this reason, fly mesh made from mild steel will rot very quickly and plastic mesh will last about two years. Aluminium or stainless steel are the best materials to use.

6.8.8 Pit excavation and lining

Most single pits for household or family use are about 1m across and 3m deep. It is difficult to excavate pits less than 0.9m diameter because there is not enough room for the person to work. There is no maximum size for a pit and sizes vary greatly.

The best shape for a pit (in plan view) is circular. Circular pits are more stable because of the natural arching effect of the ground around the hole – there are no sharp corners to concentrate the stresses (Figure 6.24). Pits with flat sides are much more likely to need supporting and require a bigger area of lining than a circular pit of the same internal volume. Many communities prefer to excavate square or rectangular pits, however, as their construction is similar to the process used for building domestic houses.

In general, the top 0.5m of a pit should always be lined, but the decision as to whether to line the rest of the pit will depend on the type of soil in which the pit is dug. When a pit is first excavated it may appear stable, and it may be impossible to tell whether or not the walls will collapse after some time. One way in which this can be assessed is to examine other excavations (such as hand-dug wells) in the area. If existing excavations have not collapsed and are not lined, then it is fairly safe to assume that pit latrine excavations will not need lining. Where there is doubt it is advisable to line the pit. Table 6.6 suggests the types of soil that, in general, do and do not require lining.

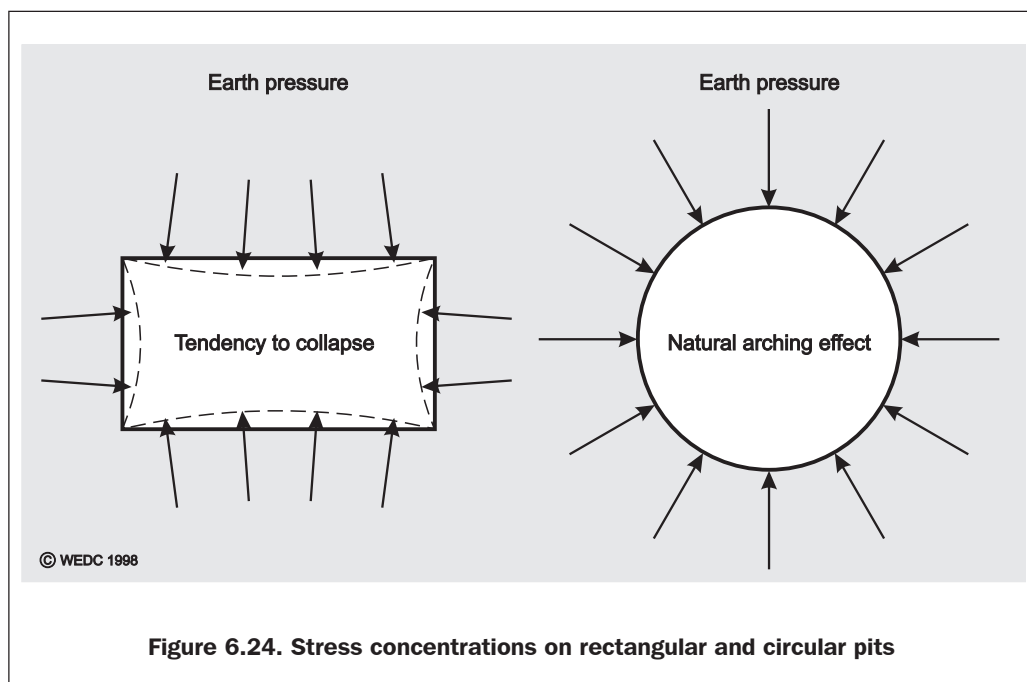

EMERGENCY SANITATION

Table 6.6. Lining requirements for different soil types

<i>Soils that require lining</i>	<i>Soils that do not require lining</i>
Soft sands and gravels Unconsolidated soils Filled land Compressed mudstones and shales	Soils with significant clay content Most consolidated sedimentary rocks Soils with high proportion of iron oxides (laterites)

6

**Failed unlined trench latrines, Sudan**

The following are commonly used pit lining materials:

- Pre-cast concrete rings
- Cast in-situ concrete
- Clay rings
- Oil drums
- Soil/cement blocks
- Local dressed stone
- Burnt bricks
- Concrete blocks
- Termite resistant timber
- Ferrocement

Bamboo and cane can only be used for short-term pits (usually less than two years). Figure 6.25 shows details of the construction of a shallow pit with lining.

EXCRETA DISPOSAL

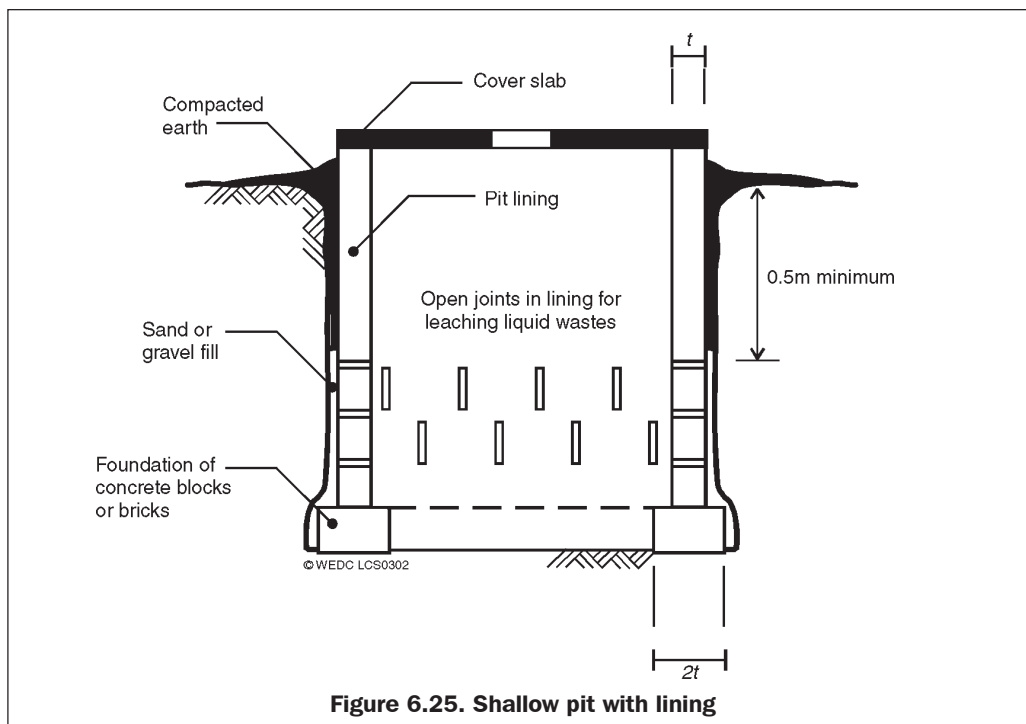

6.8.9 Sizing pits

In order to size pits or tanks it is important to determine the rate at which sludge (including faeces, urine and anal cleansing material) will accumulate, and the rate at which effluent will infiltrate into the surrounding ground. The top 0.5m of a pit should not be filled; this is to allow safe back-filling and to prevent splashing, unpleasant sights and increased incidence of problems with odour and flies.

The approximate size of the pit in m³ can be calculated from the following equation:

$$\text{Volume of pit, } V = \frac{(N \times S \times D)}{1000} + 0.5A \quad \rightarrow \text{Equation 1}$$

Where: N = number of users
 S = sludge accumulation rate (litres/person/year)
 D = design life (years)
 A = pit base area (m²)

If the size of the pit is fixed, the time taken to fill it can be calculated by rearranging Equation 1 to find the design life:

EMERGENCY SANITATION

$$\text{Design life, } D = \frac{(V - 0.5A) \times 1000}{(N \times S)}$$

Sludge accumulation rates vary greatly and local figures should be obtained if possible. In the absence of local knowledge, Table 6.7 gives guideline sludge accumulation rates for different wastes and conditions.

Table 6.7. Suggested maximum sludge accumulation rates^a

Wastes deposited and conditions	Sludge accumulation rate 'S' (litres per person per year)
Wastes retained in water where degradable anal cleaning materials are used	40
Wastes retained in water where non-degradable anal cleaning materials are used	60
Wastes retained in dry conditions where degradable anal cleaning materials are used	60
Wastes retained in dry conditions where non-degradable anal cleaning materials are used	90

^a Source: Franceys et al., 1992

Notes: The term 'wastes retained in water' when applied to a pit latrine means that wastes are in a section of the pit that is below the water table.

In many emergency situations latrines are subjected to heavy use and excreta and anal cleansing materials are added much faster than the decomposition rate. Where this is the case it is suggested that these sludge rates be increased by 50 per cent.

Worked example: A dry pit latrine is to be used by 20 people for a period of two years, and degradable corncobs are used for anal cleansing. The base of the pit is to be 1m by 1m square.

$$\begin{aligned} N &= 20 \\ S &= 60 \text{ l/year (from Table 6.7)} \\ A &= 1 \times 1 = 1 \text{ m}^2 \\ D &= 2 \text{ years} \end{aligned}$$

$$V = \frac{N \times S \times D}{1000} + 0.5A$$

$$\Rightarrow V = \frac{20 \times 60 \times 2}{1000} + 0.5 = 2.9 \text{ m}^3$$

Since the cross-sectional area is 1m², this pit would therefore need to be 2.9m deep.

EXCRETA DISPOSAL

The pit is considered full when the sludge reaches 0.5 m below the latrine slab. At this stage the pit should be replaced or emptied.

Important note: This method assumes that liquid wastes are absorbed by the surrounding ground. If liquid remains in the pit it will fill much more quickly. This is likely to happen where large volumes of water are used, where pit walls have a low infiltration capacity, or where the pit is poorly ventilated. It should also be noted that soil pores become clogged with time, reducing or even stopping infiltration. For this reason, pits should be over-sized rather than under-sized, especially where soil infiltration rates are relatively low.

Infiltration rates for different soil types are difficult to determine; for more information refer to Section 4.3.2.

6.8.10 Septic tank design

In designing a septic tank, in general, the length of the first compartment should be twice the length of the second. Guidelines for the sizing of a septic tank are given below.

$$\text{Total tank volume (C)} = \text{clear liquid retention volume (A)} + \text{sludge and scum volume (B)} + \text{ventilation space (V)}$$

Clear liquid retention volume is the volume required for storing the liquid wastewater:

$$A = Q \times T/24$$

Where: A = retention volume (m³)

Q = volume of wastewater treated per day (m³)

T = tank retention time (hours)

Table 6.8. Recommended septic tank retention times

Daily wastewater flow	Retention time 'T' (hours)
Less than 6m ³	24
Between 6 and 14m ³	33 – 1.5Q
Greater than 14m ³	12

The volume required for storing sludge and scum can be estimated by:

$$B = P \times N \times F \times S$$

Where: B = required sludge and scum volume (m³)

EMERGENCY SANITATION

P = number of people served

N = number of years between desludging (2-5 years)

F = factor for sludge digestion rate (see Table 6.9)

S = rate of annual sludge and scum production (m³/person/year)

Generally, S = 0.025m³/person/year for toilet wastes only

S = 0.040m³/person/year for toilet wastes and sillage

Ventilation space (V) is the volume of air space required between the top of the liquid and the base of the cover. This should be of a depth of 300mm, and is to allow for scum above the liquid and space for gases to escape to the ventilation system.

Total tank volume, C = A + B + V

The minimum size required to produce the necessary calm conditions in a septic tank is 1.3m³. If the value of A + B is less than this then the value 1.3m³ should be used. This minimum value does not apply to aqua privies however.

Table 6.9. Value of sludge digestion factor 'F'

Years between desludging	Average air temperature		
	Greater than 20°C all year	Between 10°C and 20°C all year	Less than 10°C in winter
1	1.3	1.15	2.5
2	1.0	1.15	1.5
3	1.0	1.0	1.27
4	1.0	1.0	1.15
5	1.0	1.0	1.06
6 or more	1.0	1.0	1.0

6.9 Emptying pits

Many of the technology choices described above involve the construction of a pit or tank which does not rely on infiltration but will need emptying if used in the long term. Where possible, pits should be appropriately sized or replaced to prevent the need for regular emptying. This is not always possible, often due to lack of space, and where this is the case facilities for emptying must be in place. Pit emptying is most difficult where pits fill fast, where hard or plastic anal cleansing materials are used, and where vehicular access is difficult.

6.9.1 Mechanical pumps

The easiest and most hygienic method for emptying latrines is to use a vacuum tanker (sometimes know as a 'sludge-gulper') which is a truck with a large tank fitted with a mechanical pump (Figure 6.26). After pumping out the contents of the pit, the tanker can be driven to a safe disposal site, such as an off-site underground pit or sewage treatment works, where the contents can be emptied.

Vacuum tankers are good at removing liquids but poor at removing solid material. Dry pits or pits containing large quantities of solid materials such as stones, sticks, plastic bags, etc. cannot be emptied. Another problem with vacuum tankers is that they are very large and may be difficult to manoeuvre close to latrines.

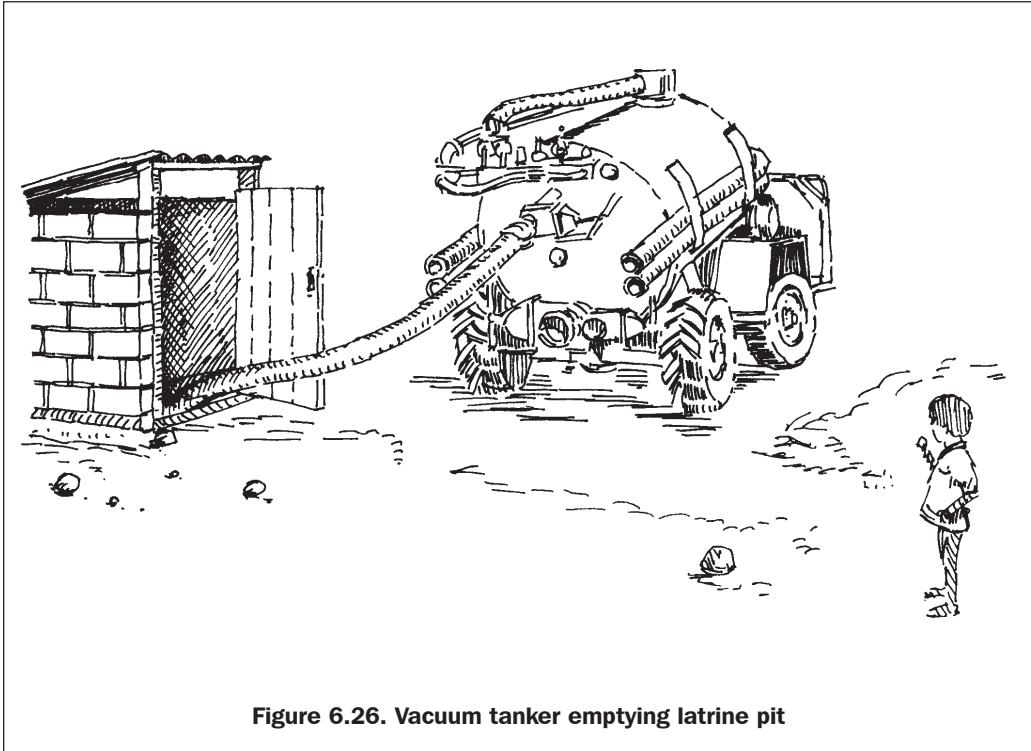
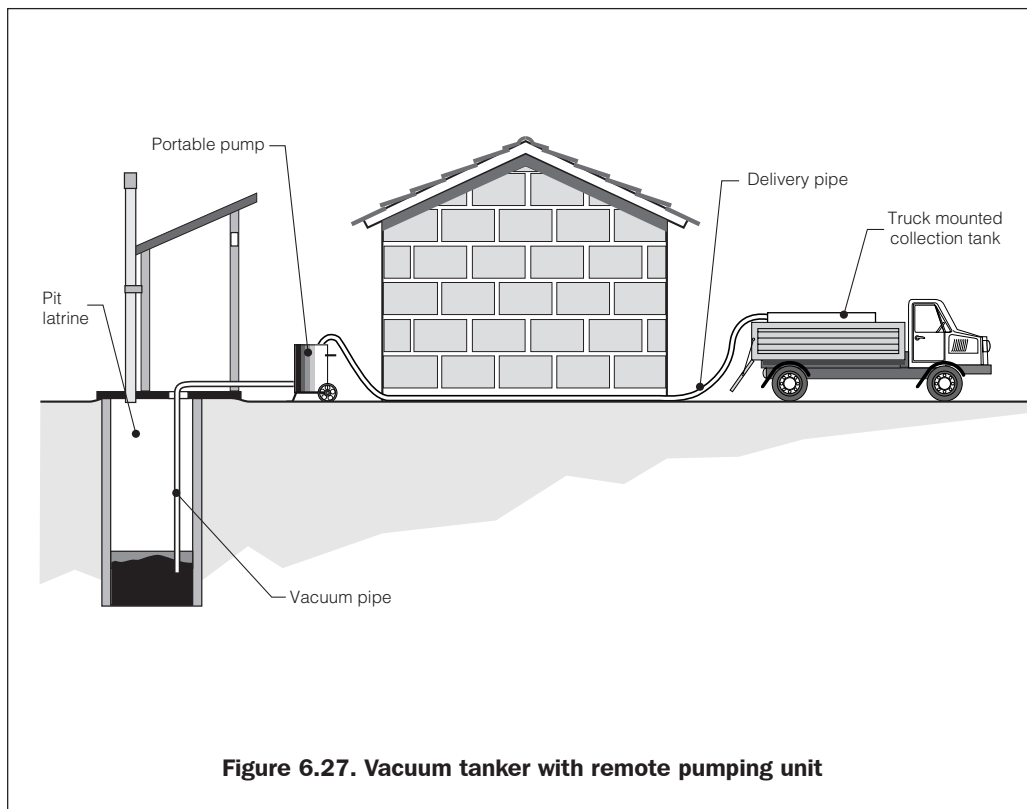

Figure 6.26. Vacuum tanker emptying latrine pit



Where a purpose-built vacuum tanker is unavailable or inappropriate, a collection tank can be mounted on a flat-bed truck, and a portable pump used to pump the waste from the pit to the tank (Figure 6.27). Such pumps must be carefully selected, particularly where hard anal cleansing materials are used, and specialist sewage pumps are recommended. Again, this is most suitable for wet conditions, and if necessary a small volume of water can be pumped into the pit first and stirred into the sludge to help liquify it.

6.9.2 Hand-operated pumps

Hand-operated latrine-emptying pumps are available in some countries. These are usually mounted on a hand-pushed cart which can be wheeled close to the pit to be emptied. These are much slower in operation than a mechanical pump and experience in their use is likely to be necessary. Such pumps are most appropriate if available and used locally, and where pit contents are wet.

6.9.3 Manual emptying

As a last resort, pits can be emptied of waste manually. This generally involves workers climbing into the pit and using shovels and buckets to take the waste out. This can then be placed in a wheelbarrow, or truck, and taken to a safe off-site disposal site. This should only be attempted once a pit has been closed and the contents left to decompose for some time (preferably at least two years).

6.9.4 Sludge reduction

Sludge reducing agents have been developed to speed up the sludge digestion process. These bioadditives are designed to boost one or more of the three basic ingredients of digestion: nutrients, enzymes and bacteria. If successful, such bioadditives could be added to pit latrine contents so that pits will require emptying less frequently. Recent trials have indicated that some bioadditives are successful in reducing sludge volumes and reducing fly infestation (Redhouse, 2001), however there appear to be significant constraints in their application. Due to the generally faster rate of sludge accumulation in emergencies it is not yet known how appropriate such technologies are in emergency sanitation programmes.

6.9.5 Sludge disposal

Sludge that has been left undisturbed for over two years is not a hazard to the environment. It can safely be spread anywhere convenient such as a garden or refuse tip. Its fertiliser value is not good but it will add humus and fibre to the soil which will promote plant growth.

Open disposal of fresh sludge into water or onto land is undesirable as it is an environmental and health hazard. The best solution is to bury sludge in pits where it cannot come into contact with humans or animals, and will not contaminate groundwater sources. Alternatives are to mix it with the influent at a nearby sewage works or compost it with domestic refuse.

References and further reading

- Adams, John (1999) *Managing Water Supply and Sanitation in Emergencies*. Oxfam: Oxford.
- Brandberg, Bjorn (1997) *Latrine Building: A handbook for implementation of the SanPlat system*. Intermediate Technology Publications: London.
- Davis, Jan and Lambert, Robert (1996) *Engineering in Emergencies: A practical guide for relief workers*. RedR / IT Publications: London.
- Franceys, R., Pickford, J. and Reed, R. (1992) *A Guide to the Development of On-site Sanitation*. WHO: Geneva.
- Kawata K. (1978) 'Water and other environmental interventions - the minimum investment concept' *American Journal of Clinical Nutrition Vol. 31 (November)*, pp. 2114 - 23.
- Médecins Sans Frontières (1994) *Public Health Engineering in Emergency Situation*. Médecins Sans Frontières: Paris.
- Redhouse, David (2001) *Less Lump per Dump: Prolonging the life of pit latrines*. Unpublished MSc Dissertation, Cranfield University: Silsoe, UK.
- Reed, R. (2000) *Low-cost Sanitation: A postgraduate distance learning module*. WEDC, Loughborough University: UK.

Chapter 7

Solid waste management

Solid waste refers here to all non-liquid wastes. In general this does not include excreta, although sometimes nappies and the faeces of young children may be mixed with solid waste. Solid waste can create significant health problems and a very unpleasant living environment if not disposed of safely and appropriately. If not correctly disposed of, waste may provide breeding sites for insect-vectors, pests, snakes and vermin (rats) that increase the likelihood of disease transmission. It may also pollute water sources and the environment.

7.1 Associated risks

7.1.1 Disease transmission

Decomposing organic waste attracts animals, vermin and flies. Flies may play a major role in the transmission of faecal-oral diseases, particularly where domestic waste contains faeces (often those of children). Rodents may increase the transmission of diseases such as leptospirosis and salmonella, and attract snakes to waste heaps.

Solid waste may also provide breeding sites for mosquitoes. Mosquitoes of the *Aedes* genus lay eggs in water stored in discarded items such as tins and drums; these are responsible for the spread of dengue and yellow fevers. Such conditions may also attract mosquitoes of the *Anopheles* genus, which transmit malaria. Mosquitoes of the *Culex* genus breed in stagnant water with high organic content and transmit microfilariaes (Médecins Sans Frontières, 1994), appropriate conditions are likely to arise where leachate from waste enters pooling water.

In times of famine or food scarcity, members of the affected population may be attracted to waste heaps to scavenge for food; this is likely to increase the risk of gastro-enteritis, dysentery and other illnesses.

7.1.2 Pollution

Poor management of the collection and disposal of solid waste may lead to leachate pollution of surface water or groundwater. This may cause significant problems if the waste contains toxic substances, or if nearby water sources are used for water supplies.

EMERGENCY SANITATION

Where large quantities of dry waste are stored in hot climates this may create a fire hazard. Related hazards include smoke pollution and fire threat to buildings and people.

7.1.3 Effect on morale

The effect of living in an unhygienic and untidy environment may lead people to become demoralised and less motivated to improve conditions around them. Waste attracts more waste and leads to less hygienic behaviour in general.

7.2 Sources and types of solid waste

7.2.1 Sources of solid waste

In most emergency situations the main sources of solid waste are:

- Medical centres
- Food stores
- Feeding centres
- Food distribution points
- Slaughter areas
- Warehouses
- Agency premises
- Markets
- Domestic areas

Appropriate solid waste management strategies may vary for institutional, communal and domestic sources, depending on types and volumes of waste. Waste from medical centres poses specific health hazards and for this reason is considered separately in Chapter 8.

7.2.2 Type and quantity of waste

The type and quantity of waste generated in emergency situations varies greatly. The main factors affecting these are:

- the geographical region (developed or less-developed country or region);
- socio-cultural practices and material levels among affected population;
- seasonal variations (affecting types of food available);
- the stage of emergency (volume and composition of waste may change over time); and
- the packaging of food rations.

In general, the volume of waste generated is likely to be small and largely degradable where the population is of rural origin and the food rations supplied are unpackaged dry foodstuffs. Displaced urban populations are more likely to generate larger volumes of non-degradable waste, especially where packaged food rations are provided.

SOLID WASTE MANAGEMENT

Guideline values suggest that each person is likely to produce 0.5-1.0 litres of refuse per day with an organic content of 25 to 35 per cent and a moisture content between 10 and 60 per cent (Adams, 1999). However, this is likely to vary greatly and estimates should be made locally.

Different categories of solid waste include:

Organic waste:	Waste from preparation of food, market places, etc.
Combustibles:	Paper, wood, dried leaves, packaging for relief items, etc. (high organic and low moisture content)
Non-combustibles:	Metal, tin cans, bottles, stones, etc.
Ashes/dust:	Residue from fires used for cooking
Bulky waste:	Tree branches, tyres, etc.
Dead animals:	Carcasses of domestic animals and livestock
Hazardous waste:	Oil, battery acid, medical waste
Construction waste:	Roofing, rubble, broken concrete, etc.



Children and solid waste in a refugee camp, Turkey

EMERGENCY SANITATION



Collected market waste, Tanzania

SOLID WASTE MANAGEMENT

7.3 Initial steps

In order to establish effective solid waste management in the affected area the following process should be used:

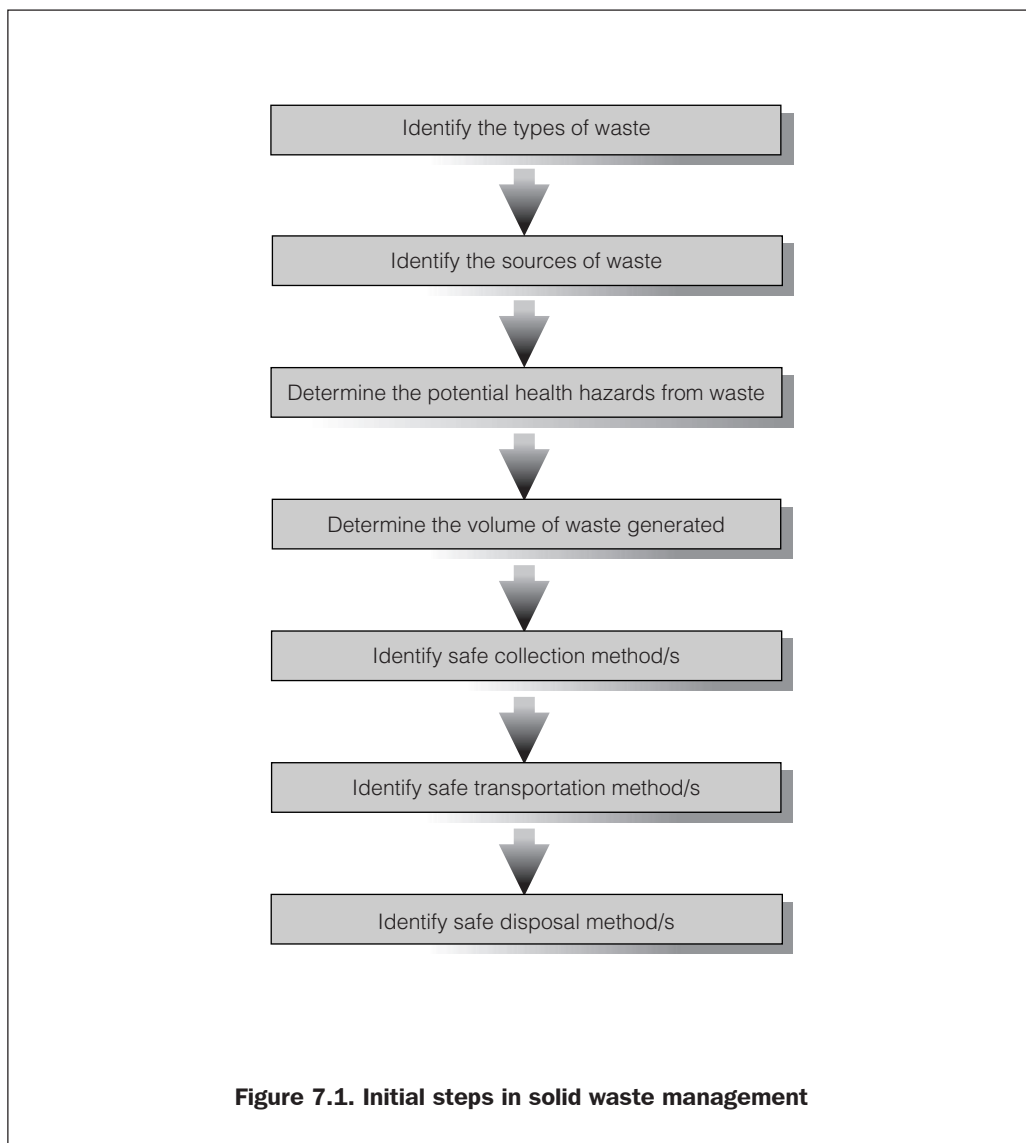

7.4 Key components of solid waste management

Solid waste management can be divided into five key components:

- Generation
- Storage
- Collection
- Transportation
- Disposal

7.4.1 Generation

Generation of solid waste is the stage at which materials become valueless to the owner and since they have no use for them and require them no longer, they wish to get rid of them. Items which may be valueless to one individual may not necessarily be valueless to another. For example, waste items such as tins and cans may be highly sought after by young children.

7.4.2 Storage

Storage is a system for keeping materials after they have been discarded and prior to collection and final disposal. Where on-site disposal systems are implemented, such as where people discard items directly into family pits, storage may not be necessary. In emergency situations, especially in the early stages, it is likely that the affected population will discard domestic waste in poorly defined heaps close to dwelling areas. If this is the case, improved disposal or storage facilities should be provided fairly quickly and these should be located where people are able to use them easily. Improved storage facilities include:

- Small containers: household containers, plastic bins, etc.
- Large containers: communal bins, oil drums, etc.
- Shallow pits
- Communal depots: walled or fenced-in areas

In determining the size, quantity and distribution of storage facilities the number of users, type of waste and maximum walking distance must be considered. The frequency of emptying must also be determined, and it should be ensured that all facilities are reasonably safe from theft or vandalism.

7.4.3 Collection

Collection simply refers to how waste is collected for transportation to the final disposal site. Any collection system should be carefully planned to ensure that storage facilities do not become overloaded. Collection intervals and volumes of collected waste must be estimated carefully.

7.4.4 Transportation

This is the stage when solid waste is transported to the final disposal site (see 7.6 for more details). There are various modes of transport which may be adopted and the chosen method depends upon local availability and the volume of waste to be transported. Types of transportation can be divided into three categories:

SOLID WASTE MANAGEMENT

- Human-powered: open hand-cart, hand-cart with bins, wheelbarrow, tricycle
- Animal-powered: donkey-drawn cart
- Motorised: tractor and trailer, standard truck, tipper-truck

7.4.5 Disposal

The final stage of solid waste management is safe disposal where associated risks are minimised. There are four main methods for the disposal of solid waste:

- Land application: burial or landfilling
- Composting
- Burning or incineration
- Recycling (resource recovery)

The most common of these is undoubtedly land application, although all four are commonly applied in emergency situations. Details of disposal on-site and off-site can be found in Sections 7.5 and 7.7 respectively.

7.5 On-site disposal options

The technology choices outlined below are general guidelines for disposal and storage of waste on-site, these may be adapted for the particular site and situation in question.

7.5.1 Communal pit disposal

Perhaps the simplest solid waste management system is where consumers dispose of waste directly into a communal pit. The size of this pit will depend on the number of people it serves. The long-term recommended objective is six cubic metres per fifty people. The pit should be fenced off to prevent small children falling in and should generally not be more than 100m from the dwellings to be served. Ideally, waste should be covered at least weekly with a thin layer of soil to minimise flies and other pests. Figure 7.2 illustrates a simple communal pit.

Advantages: It is rapid to implement; and requires little operation and maintenance.

Constraints: The distance to communal pit may cause indiscriminate disposal; and waste workers required to manage pits.

EMERGENCY SANITATION

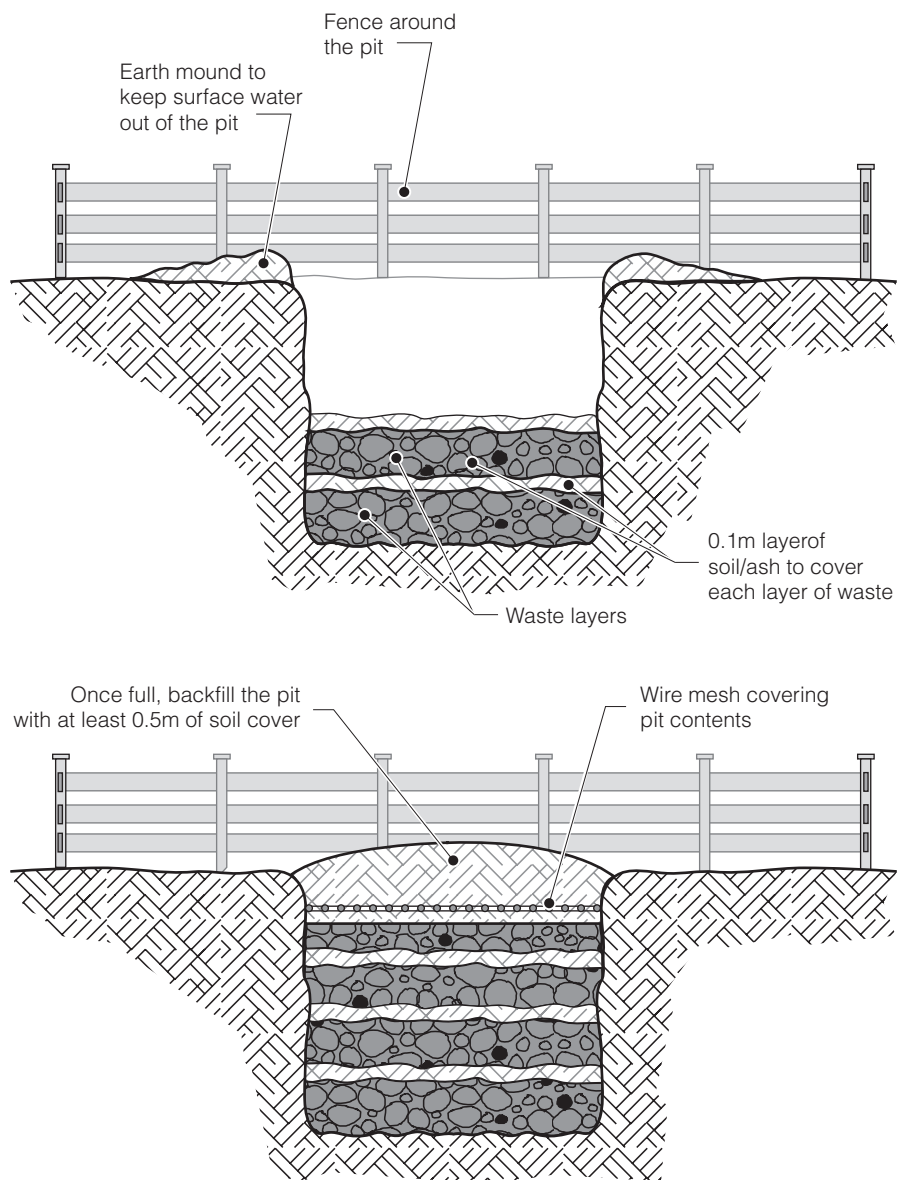

Figure 7.2. Communal solid waste pit

SOLID WASTE MANAGEMENT

7.5.2 Family pit disposal

Family pits may provide a better long-term option where there is adequate space. These should be fairly shallow (up to 1m deep) and families should be encouraged to regularly cover waste with soil from sweeping or ash from fires used for cooking. This method is best suited where families have large plots and where organic food wastes are the main component of domestic refuse.

Advantages: Families are responsible for managing their own waste; no external waste workers are required; and community mobilisation can be incorporated into hygiene promotion programme.

Constraints: Involves considerable community mobilisation for construction, operation and maintenance of pits; and considerable space is needed.

7.5.3 Communal bins

Communal bins or containers are designed to collect waste where it will not be dispersed by wind or animals, and where it can easily be removed for transportation and disposal. Plastic containers are generally inappropriate since these may be blown over by the wind, can easily be removed and may be desirable for alternative uses. A popular solution is to provide oil drums cut in half (Figure 7.3). The bases of these should be perforated to allow liquid to pass out and to prevent their use for other purposes. A lid and handles can be provided if necessary.

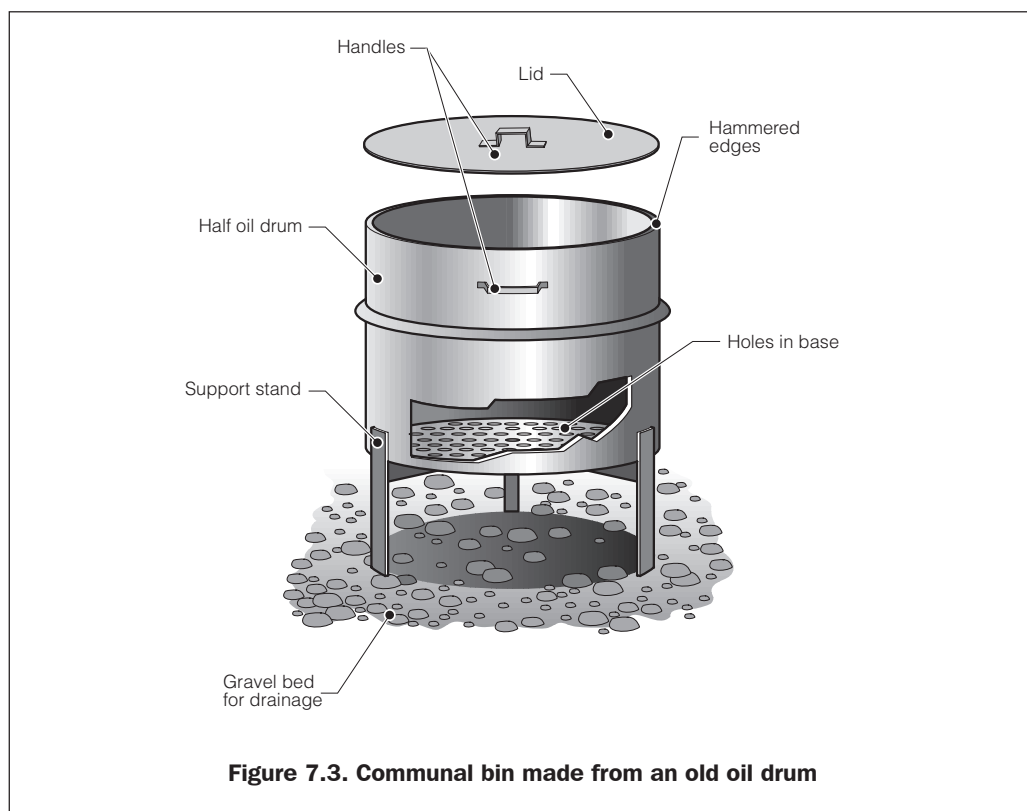

Figure 7.3. Communal bin made from an old oil drum

EMERGENCY SANITATION

In general, a single 100-litre bin should be provided for every fifty people in domestic areas, every one hundred people at feeding centres and every ten market stalls. In general, bins should be emptied daily.

Advantages: Bins are potentially a highly hygienic and sanitary management method; and final disposal of waste well away from dwelling areas.

Constraints: Significant collection, transportation and human resources are required; system takes time to implement; and efficient management is essential.

7.5.4 Family bins

Family bins are rarely used in emergency situations since they require an intensive collection and transportation system and the number of containers or bins required is likely to be huge. In the later stages of an emergency, however, community members can be encouraged to make their own refuse baskets or pots and to take responsibility to empty these at communal pits or depots.

Advantages: Families are responsible for maintaining collection containers; and potentially a highly sanitary management method.

Constraints: In general, the number of bins required is too large; significant collection, transportation and human resources are required; takes time to implement; and efficient management essential.

7.5.5 Communal disposal without bins

For some public institutions, such as markets or distribution centres, solid waste management systems without bins can be implemented, whereby users dispose of waste directly onto the ground. This can only work if cleaners are employed to regularly sweep around market stalls, gather waste together and transport it to a designated off-site disposal site. This is likely to be appropriate for vegetable waste but slaughterhouse waste should be disposed of in liquid-tight containers and buried separately.

Advantages: System rapid to implement; there is minimal reliance on actions of users; and it may be in line with traditional/usual practice.

Constraints: Requires efficient and effective management; and full-time waste workers must be employed.

7.6 Transportation options

Where bins or collection containers require emptying, transportation to the final disposal point is required. As described, waste transportation methods may be human-powered, animal-powered or motorised.

7.6.1 Human-powered

Wheelbarrows are ideal for the transportation of waste around small sites such as markets but are rarely appropriate where waste must be transported considerable distances off-site. Handcarts provide a better solution for longer distances since these can carry significantly more waste and can be pushed by more than one person. Carts may be open or can be fitted with several containers or bins.

SOLID WASTE MANAGEMENT

7.6.2 Animal-powered

Animal-powered transportation means such as a horse or donkey with cart are likely to be appropriate where they are commonly used locally. This may be ideal for transportation to middle distance sites

7.6.3 Motorised

Where the distance to the final disposal site is great, or where the volume of waste to be transported is high, the use of a motorised vehicle may be the only appropriate option. Options include tractor and trailer, a standard truck, or a tipper-truck, the final choice depending largely on availability and speed of procurement.

Figure 7.4 illustrates a number of refuse collection vehicles and containers.

7

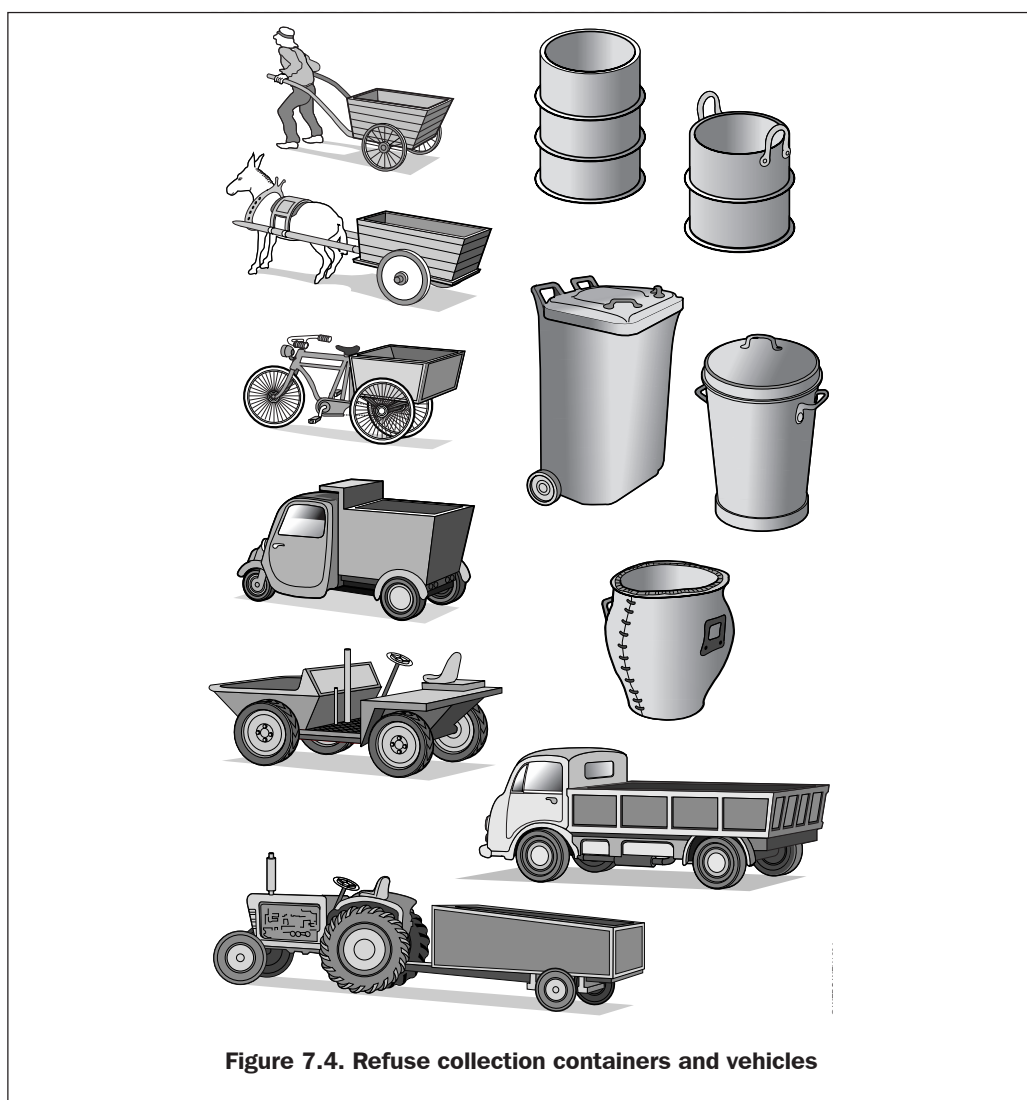

Figure 7.4. Refuse collection containers and vehicles

EMERGENCY SANITATION

For large volumes of waste it may sometimes be appropriate to have a two-stage transportation system requiring a transfer station. For example, waste is transported by handcart to a transfer station where it is loaded into a truck to be taken to an off-site disposal site several kilometres away (Figure 7.5).

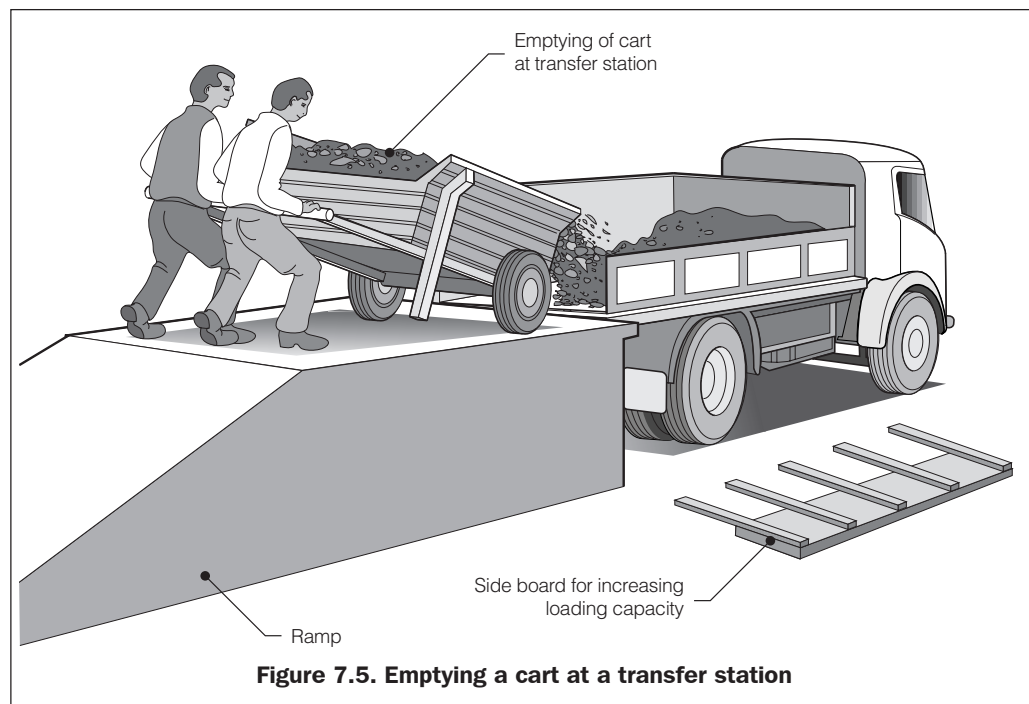

Figure 7.5. Emptying a cart at a transfer station

7.7 Off-site disposal options

The technology choices outlined below are general options for the final disposal of waste off-site.

7.7.1 Landfilling

Once solid waste is transported off-site it is normally taken to a landfill site. Here the waste is placed in a large excavation (pit or trench) in the ground, which is back-filled with excavated soil each day waste is tipped. Ideally, about 0.5m of soil should cover the deposited refuse at the end of each day to prevent animals from digging up the waste and flies from breeding (Figure 7.6).

The location of landfill sites should be decided upon through consultation with the local authorities and the affected population. Sites should preferably be fenced, and at least one kilometre downwind of the nearest dwellings.

Advantages: A sanitary disposal method if managed effectively.

Constraints: A reasonably large area is required.

SOLID WASTE MANAGEMENT

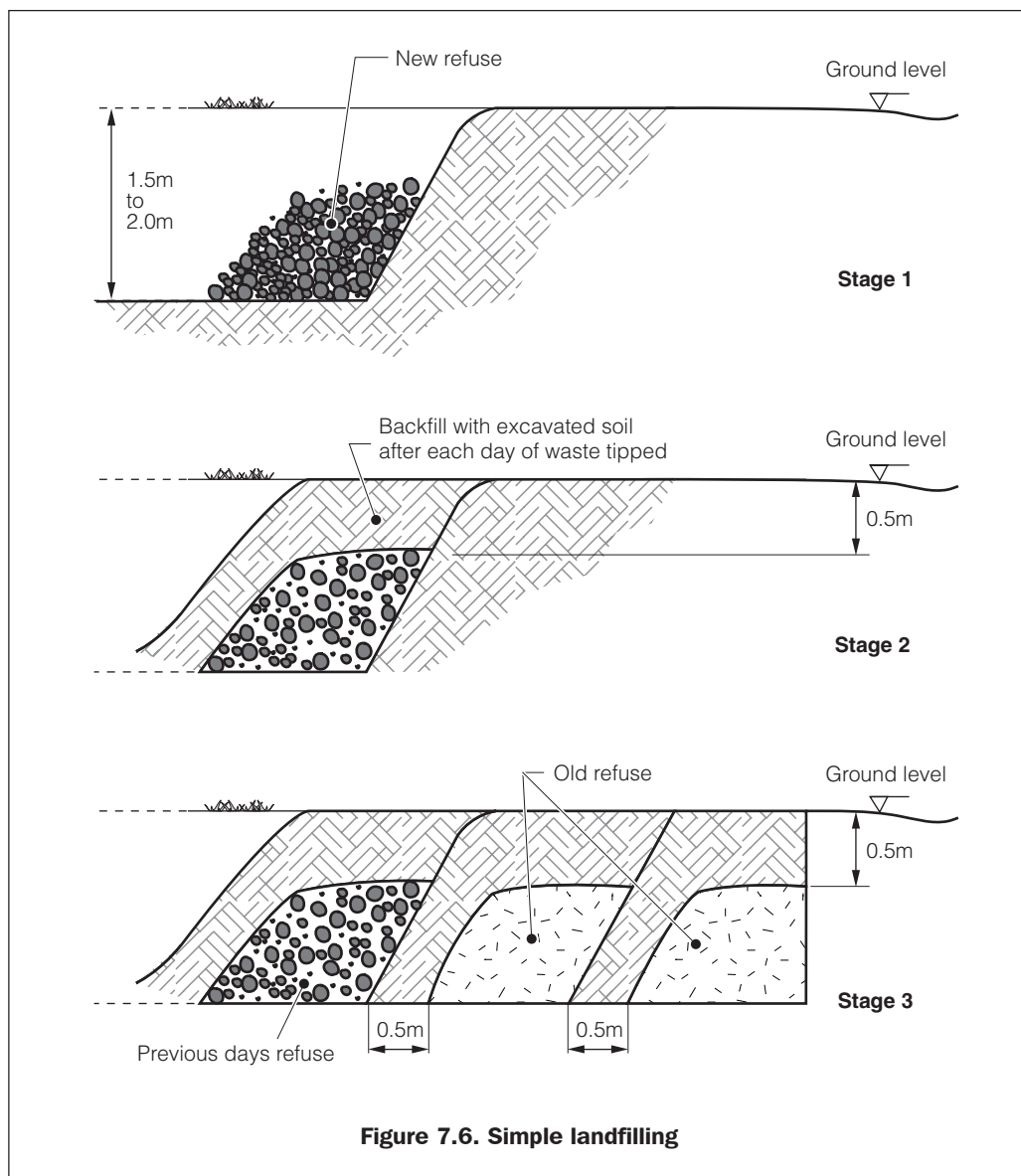
**7.7.2 Incineration**

Although burning or incineration is often used for the disposal of combustible waste, this should generally only take place off-site or a considerable distance downwind of dwellings. Burning refuse within dwelling areas may create a significant smoke or fire hazard, especially if several fires are lit simultaneously. Burning may be used to reduce the volume of waste and may be appropriate where there is limited space for burial or landfill. Waste should be ignited within pits and covered with soil once incinerated, in the same manner as landfilling. The same constraints for siting landfill sites should be applied here also.

Advantages: Burning reduces volume of combustible waste considerably; and it is appropriate in off-site pits to reduce scavenging.

Constraints: There can be smoke or fire hazards.

7.7.3 Composting

Simple composting of vegetables and other organic waste can be applied in many situations. Where people have their own gardens or vegetable plots, organic waste can be dug into the soil to add humus and fibre. This makes the waste perfectly safe and also assists the growing process. This should be encouraged wherever possible, particularly in the later stages of an emergency programme.

Properly managed composting requires careful monitoring of decomposing waste to control moisture and chemical levels and promote microbial activity. This is designed to produce compost which is safe to handle and which acts as a good fertiliser. Such systems require considerable knowledge and experience and are best managed centrally. In general, they are unlikely to be appropriate in emergencies.

Advantages: Composting is environmentally friendly; and beneficial for crops.

Constraints: Intensive management and experienced personnel are required for large-scale operations.

7.7.4 Recycling

Complex recycling systems are unlikely to be appropriate but the recycling of some waste items may be possible on occasions. Plastic bags, containers, tins and glass will often be automatically recycled since they are likely to be scarce commodities in many situations. In most developing country contexts there exists a strong tradition of recycling leading to lower volumes of waste than in many more developed societies.

Advantages: Recycling is environmentally friendly.

Constraints: There is limited potential in most emergency situations; and it is expensive to set up.

7.8 Intervention levels

Table 7.1 indicates general intervention strategies for the storage and disposal of solid waste in different emergency scenarios.

SOLID WASTE MANAGEMENT

Table 7.1. Recommended interventions for different scenarios

<i>Scenarios and recommended interventions</i>	<i>The affected population go through a transit camp immediately after a disaster</i>	<i>The affected population remain in a temporary location for up to six months</i>	<i>The affected population stay in the affected area immediately after a disaster</i>	<i>The affected population move to a new area and are likely to remain for more than a year</i>
Immediate action	<ul style="list-style-type: none"> ■ Clearing of scattered waste ■ Burning and burial of waste on site ■ Temporary communal pits ■ Temporary communal bins and off-site disposal ■ Repairing or upgrading of existing facilities 			
Short-term measure	<ul style="list-style-type: none"> ■ Communal pits ■ Family pits ■ Communal bins and off-site disposal 			
Long-term measure			<ul style="list-style-type: none"> ■ Communal pits ■ Family pits ■ Communal bins and off-site disposal ■ Repairing or upgrading of existing facilities ■ Recycling 	

7.9 Protective measures

In order to minimise disease transmission there are several protective measures that can be undertaken. These concern equipment for staff and the siting and management of disposal sites.

7.9.1 Staff

It is important that workers employed to collect and transport solid waste are provided with appropriate clothing and equipment. Gloves, boots and overalls should be provided wherever possible. Where waste is burned, or is very dusty, workers should have protective masks. Water and soap should be available for hand and face washing, and changing facilities should be provided where appropriate.

7.9.2 Siting of disposal sites

The location of all disposal sites should be determined through consultation with key stakeholders including local government officials, representatives of local and displaced populations, and other agencies working in the area. Appropriate siting should minimise the effects of odour, smoke, water pollution, insect vectors and animals.

EMERGENCY SANITATION

On-site disposal is generally preferred since this requires no transportation and staff needs are low. This is appropriate where volumes of waste are relatively small, plenty of space is available and waste is largely organic or recyclable.

If the volumes of waste generated are large, or space within the site is severely limited, it may be necessary to dispose of waste off-site. Where off-site disposal is to be used the following measures should be taken in selecting and developing an appropriate site:

- Locate sites at least 500m (ideally 1 kilometre) downwind of nearest settlement.
- Locate sites downhill from groundwater sources.
- Locate sites at least 50m from surface water sources.
- Provide a drainage ditch downhill of landfill site on sloping land.
- Fence and secure access to site.

Careful assessment should be made to determine who owns the proposed site and to ensure that apparently unused areas are not in fact someone's farm or back yard.

References and further reading

- Adams, John (1999) *Managing Water Supply and Sanitation in Emergencies*. Oxfam: Oxford.
- Ali, Mansoor, Cotton, Andrew and Westlake, Ken (1999) *Down to Earth: Solid waste disposal for low-income countries*. WEDC, Loughborough University: UK.
- Cairncross, S. and Feachem, R. (1983) *Environmental Health Engineering in the Tropics: An introductory text*. John Wiley & Sons, Chichester.
- Davis, Jan and Lambert, Robert (1996) *Engineering in Emergencies: A practical guide for relief workers*. RedR / IT Publications: London.
- Médecins Sans Frontières (1994) *Public Health Engineering in Emergency Situation*. Médecins Sans Frontières: Paris.
- Reed, R. and P.T. Dean, P.T. (1994) Recommended Methods for the Disposal of Sanitary Wastes from Temporary Field Medical Facilities *Disasters* Vol 18, No 4.

Chapter 8

Waste management at medical centres

The term ‘medical centre’ can be used to refer to field hospitals, outpatient clinics and any other location where medical consultation, diagnosis or treatment is conducted. Some wastes from medical centres pose specific and sometimes severe health hazards; for this reason it is important that medical centre waste is managed separately from general solid waste and that management systems are more strictly controlled. The disposal of dead bodies is dealt with in Chapter 9.

8.1 Types and sources of medical waste

The waste generated in a medical centre can be divided into two main categories:

- general (or non-clinical) waste; and
- medical (or clinical) waste.

General or non-clinical waste usually constitutes between 75 and 90 per cent of the total waste generated at medical centres; this includes office and kitchen waste (WHO, 1988 quoted by Appleton and Ali, 2000). The remaining 10 to 25 per cent of waste can be classed as medical waste which presents the greatest health risk to humans (Figure 8.1).

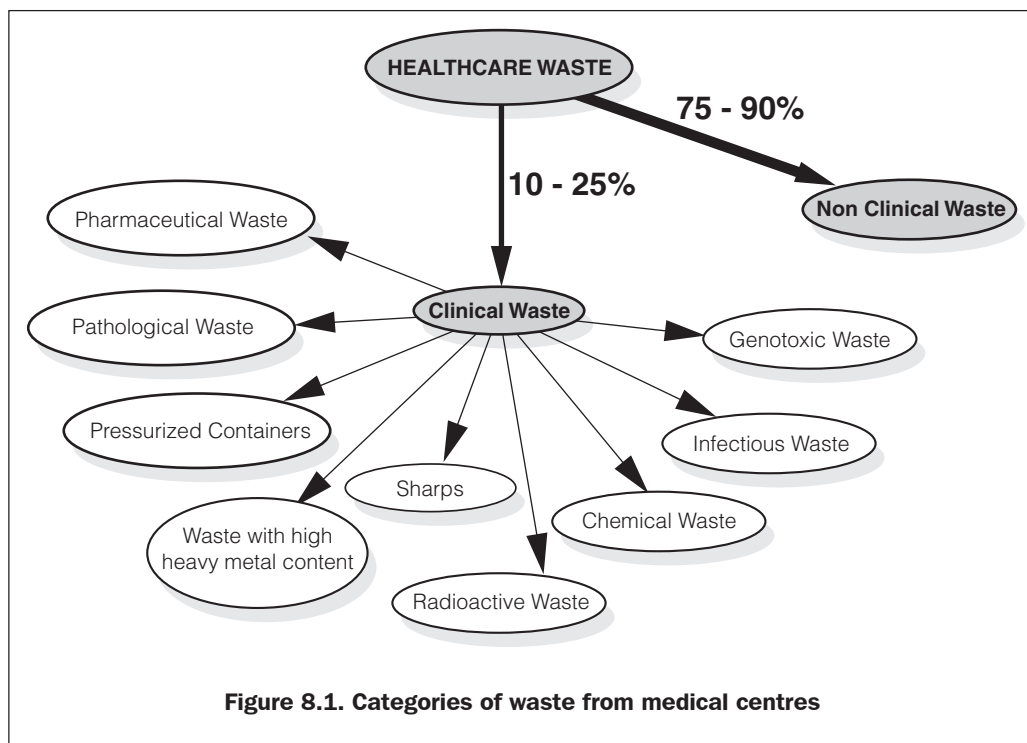

Medical waste can be further divided into the following categories:

- Infectious waste (lab cultures, wastes from isolation wards, tissues, used dressings)
- Pathological waste (body parts, human foetuses, placentas, blood, other body fluids)
- Pharmaceutical waste (unwanted drugs, expired drugs)
- Chemical waste (chemicals from diagnostic work, cleaning materials)
- Sharps (needles, blades and broken glass)
- Radioactive waste (radioactive substances from radiotherapy and lab work)
- Pressurised containers (gas cylinders, cartridges and aerosol cans)
- High heavy metal content (batteries, broken thermometers, blood pressure gauges)

In most emergency situations the predominant types of medical waste are infectious waste, pathological waste and sharps. These may be used as categories for segregation, but this will depend on the technologies selected for the final disposal of different waste types (see 8.5).

8.2 Associated risks

General, non-clinical, waste poses the same hazards as general solid waste (Chapter 7), but medical or clinical waste poses significantly increased hazards. The most obvious of these is the transmission of infectious diseases (e.g. Hepatitis B and HIV) through direct contact with infected waste items such as used needles, discarded dressings and human tissues or fluids.

WASTE MANAGEMENT AT MEDICAL CENTRES

Non-direct risks include disease transmission by vectors and pollution of water sources and the environment. Less common potential risks include the risk of cancer, burns and skin irritation from radioactive waste or toxic chemicals.

8.2.1 Transmission pathways

The first step in waste management is to identify the potential routes for disease transmission. Possible pathways between medical waste and the population include:

- Direct contact
- Contact through vectors
- Airborne transmission
- Pollution of water sources
- Pollution of the environment

In order to minimise risks it is essential to attempt to break potential pathways. Table 8.1 summarises the risks, pathways and hazards of medical waste.

Table 8.1. Risks, pathways and hazards of medical waste (after Appleton and Ali, 2000)		
<i>Risk</i>	<i>Pathway</i>	<i>Hazard</i>
Contraction of disease/ infection	Direct or indirect contact through a carrier	Pathological wastes and infectious wastes may transmit disease and infection through direct contact or via vectors
Cuts	Direct contact	Sharp waste including needles, glass and scalpels may cause cuts which provide entry into the body for infection
Ineffective medical care	Direct	Consumption of expired pharmaceu- ticals possible through inappropriate prescription by unscrupulous medical practitioners
Cancer	Direct or indirect contact, or proximity to waste	Radioactive waste
Burns and skin irritation	Direct or indirect contact, or proximity to waste	Toxic chemicals Radioactive waste
Injury from explosion	Being within the vicinity when explosion occurs	Pressurised containers
Pollution of groundwater, surface water and the air	Direct or indirect contact with polluted water or release to atmosphere	Toxic chemical wastes Pharmaceuticals Waste with heavy metal contact

8.2.2 Who is at risk from medical waste?

Those most at risk from medical waste are:

- Medical staff
- Medical waste workers
- Waste-pickers
- Children (playing near disposal sites)
- Drug addicts (who scavenge for used needles and disposed medicines)
- Medical centre visitors and patients

Specific groups who come directly into contact with medical waste should be targeted for appropriate education and training. This aspect should be given at least equal priority to the provision of appropriate waste management facilities.

8.3 Minimising risks

8.3.1 Key measures to reduce hazards

Actual hazards resulting from medical waste can be reduced by:

- segregating general waste from medical waste;
- efficiently separating different categories of medical waste at the point of generation;
- labelling hazardous wastes;
- disinfecting before disposal (where possible);
- disposing of different categories of medical waste into appropriate disposal systems; and
- incinerating to destroy hazards (note that ineffective incineration may not remove all hazards and may cause air pollution).

8.3.2 Key measures to cut transmission pathways

Direct contact between people and hazardous waste can be prevented by:

- providing personal protective clothing and equipment (e.g. heavy duty gloves, safety glasses, overalls, etc.);
- designing systems to minimise contact (e.g. good storage facilities, more effective transportation, lack of double-handling, etc.);
- restricting access to medical waste pits or landfill sites; and
- improving education about dangers of medical waste.

Indirect contact between people and hazardous waste can be reduced by:

- applying vector control methods (e.g. covering waste);
- protecting water sources from contamination;
- implementing good hygiene practices when dealing with waste (e.g. handwashing); and
- implementing final disposal by effective sanitary landfill.

8.3.3 Key measures to protect the population

Increased protection to those most at risk can be provided by:

- improving education, training and awareness raising (concerning safety and risk recognition) for medical staff, medical waste workers and others who are likely to come into contact with medical waste;
- immunising those in contact with medical waste against certain diseases, e.g. Hepatitis B and tetanus; and
- providing better access to healthcare for those in contact with waste.

8.4 Segregation, storage and transportation

Prior to final disposal, all wastes must be stored safely and transported to respective disposal sites. It is important that different types of waste are stored separately in order to prevent contamination of 'clean' waste by infectious or pathological wastes, and to allow easy transportation.

8.4.1 Segregation

The first step is to determine how waste should be separated or segregated. This will depend on the composition and quantities of waste generated, and how they are to be disposed of. The fact that this may change over time should be considered and on-going monitoring should occur.

In general, the segregation categories and disposal regimes in Table 8.2 are recommended for emergency situations.

In general, it is recommended that each treatment, diagnosis and consultation area of the medical centre (including wards, laboratories and immunisation points) has a set of three segregated containers: the first for general waste; the second for infectious and pathological waste; and the third for sharps. If pathological wastes such as placentas are to be disposed of separately from infectious waste, for example in a placenta pit, then a fourth type of container should be provided for this and disposal should take place immediately.

Table 8.2. Segregation categories

<i>Category of waste</i>	<i>Description</i>	<i>Disposal methods</i>
1. General waste	Kitchen waste, paper and packaging waste, etc.	On-site pit disposal Burning Sanitary landfilling
2. Pathological and infectious waste	Lab cultures, wastes from isolation wards, tissues, body parts, blood and other body fluids, etc.	Incineration Burning and burial Placenta pit
3. Sharps	Needles, blades, scalpels, glassware, infusion sets, etc.	Incineration at sufficient temperature (>1000°C) Sharps pit

EMERGENCY SANITATION

8.4.2 Storage

All containers should have lids and should be water-tight in order to hold liquids. Open cardboard boxes are not recommended since these can easily be tipped over and they disintegrate easily. The size of container will depend on the volume of waste generated in each location but should be easy to handle and transport. It is recommended that containers of uniform colour are provided for each type of waste throughout the medical centre. This facilitates ease of identification and helps to avoid confusion. In addition, containers may be labelled, especially when containing infectious waste or sharps.

It is recommended that needles are stored in specially designed sharps containers. These containers should be disposed of together with their contents to eliminate further handling of potentially hazardous needles. Simple sharps containers can be made from empty pharmaceutical or medicine containers. The lid of the plastic container is glued or taped shut and a small triangular slot is cut in the lid. Following an injection the user inserts the needle and syringe in the slot, slides it to the narrow point of the slot and pulls the syringe away leaving the needle safely in the container (Figure 8.2). This prevents any handling of the used needle.

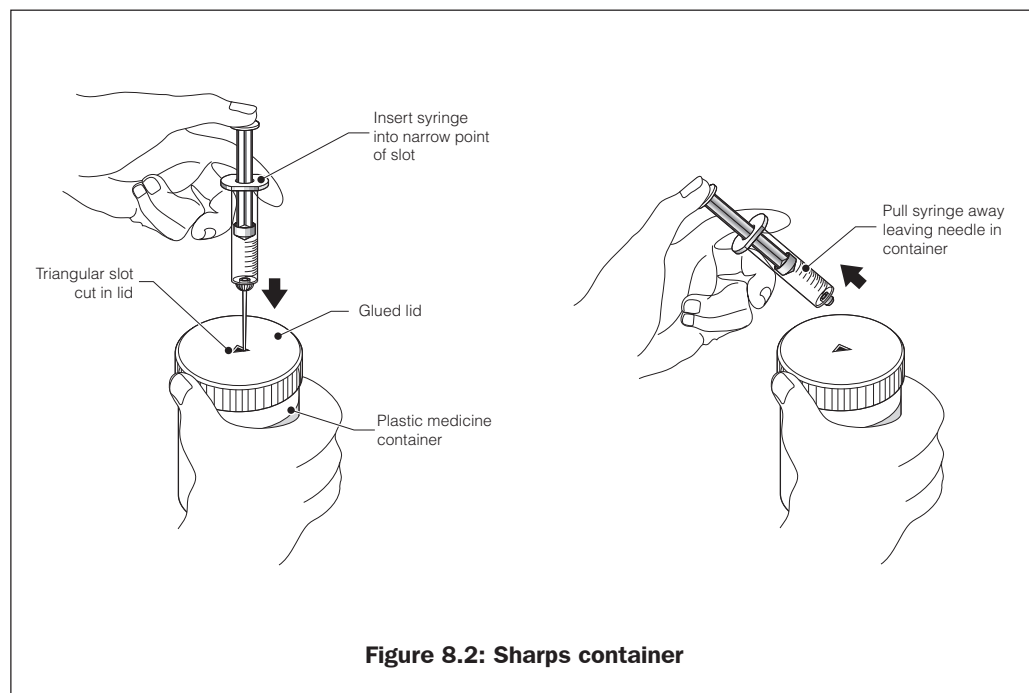

8.4.3 Disinfection

In general, the disinfection of solid waste using chemical disinfectants is only effective if such waste has been shredded beforehand. It is also inadequate for pharmaceutical, chemical and some types of infectious waste (Appleton and Ali, 2000). Disinfectants may themselves be hazardous and their use is not recommended in most emergency situations, unless treating liquid waste or sewage.

8.4.4 Transportation

Segregated storage containers should be designed so that they can be carried directly to the final disposal point. Containers must therefore be easy to carry, preferably with handles and a tight-fitting but easy-to-remove lid. Where waste is disposed of in an incinerator or pit this should be designed so that it is relatively easy to empty the container contents without spillage.

8.5 Disposal technology choices

Possible options for the disposal of different waste types are given below.

8.5.1 General solid waste pits

The disposal options for general solid waste are the same as those in Chapter 7. Where an off-site disposal system is in place, general waste from medical centres can be incorporated into that system. Alternatively, if solid waste is disposed of on-site it is likely to be appropriate to excavate a pit for general waste in the vicinity of the medical centre. This should be approximately 100m from the nearest habitable building.

8.5.2 Incineration

Incineration is an efficient and effective way to reduce organic and combustible waste to inorganic matter. Appropriate wastes should be at least 60 per cent combustible with a moisture content of not more than 30 per cent. A medical waste incinerator is designed to disinfect and render hazardous waste safe. It may be suitable for pathological, infectious or sharp wastes but should not be used for general solid waste, since this is an inefficient use of energy. Incinerators vary greatly from the sophisticated to the basic, and consequently performance, and therefore safety, varies greatly. Additional fuel is usually required if they are to operate correctly.

Figure 8.3 shows a temporary incinerator constructed from a disused oil drum. This is simple, cheap and quick to construct and ideal for the early stages of an emergency, but its efficiency is generally poor. The drum can be fitted with a chimney which should be at least 1m taller than surrounding structures, and this should help to remove smoke and reduce the effects of pollution. The incinerator can be built directly above a sealed pit so that the ash can be emptied from the base of the drum and deposited directly into the pit below. Alternatively the ash can be removed and buried nearby.

EMERGENCY SANITATION

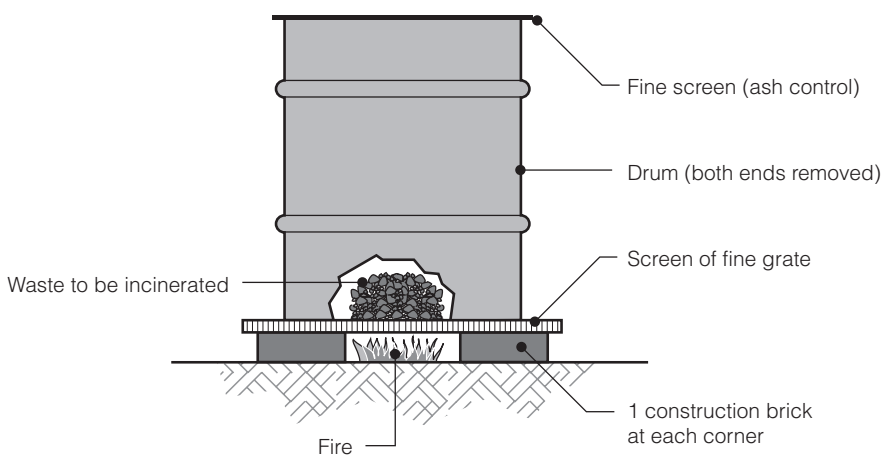

Figure 8.3. Temporary drum incinerator

Strictly speaking this is not an incinerator but a burner since it is unlikely to reduce all waste to ashes. Basic incinerators such as this often cause serious problems with emissions and should always be positioned at least 100m from the medical centre and other habitable buildings, to minimise the effects of smoke pollution. However, it is important that this is accompanied by appropriate containers for transportation and protective clothing. Sharp wastes such as needles will not be incinerated completely and therefore should be disposed of elsewhere if possible.

Advantages: Incinerators are cheap and quick to construct; and destroy infectious waste.

Constraints: There are smoke and odour hazards; and it is ineffective for the disposal of sharps.



Oil drum burner, Zambia

WASTE MANAGEMENT AT MEDICAL CENTRES

A more suitable long-term intervention is a properly designed incinerator (Figure 8.4). This is designed to operate at temperatures of 1000°C and above, and will reduce even metallic waste to a fine uniform ash.

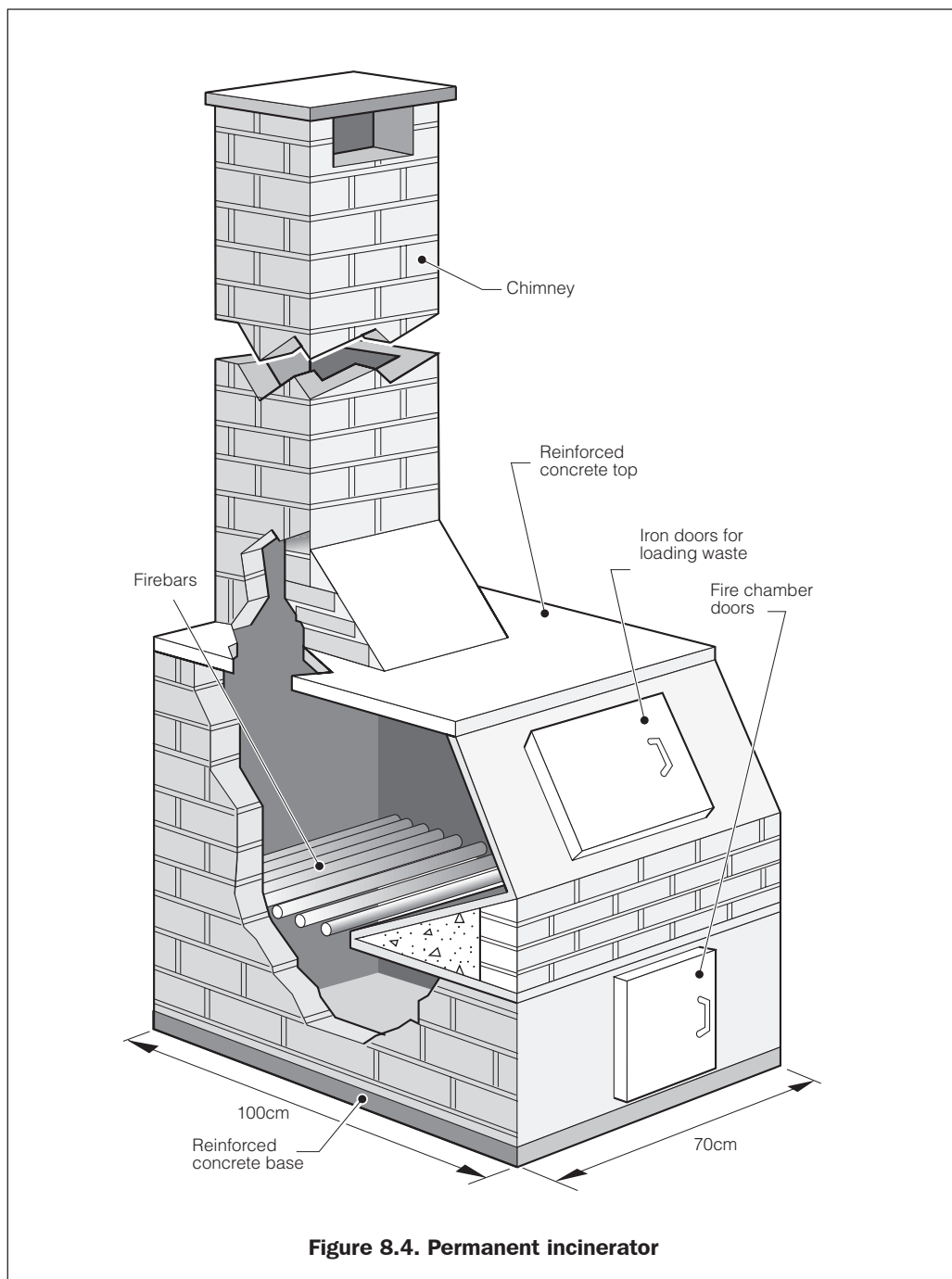

Figure 8.4. Permanent incinerator

EMERGENCY SANITATION

A permanent incinerator may be constructed from brick and concrete with iron or metal doors. An incinerator of this chamber size (approximately 1.0m x 0.5m base) will be able to combust about 100kg of waste per hour (Médecins Sans Frontières, 1994).

Advantages: Highly effective at disposing of sharps, and infectious and pathological waste.

Constraints: Expensive and time-consuming to construct; and difficult to operate at the appropriate temperature.

8.5.3 Sharps pits

Where it is not possible or appropriate to construct a proper incinerator, sharps should be disposed of in a specially built and sealed sharps pit (Figure 8.5). This option is preferable to disposal in an inefficient temporary burner in most situations.

A sharps pit can be a lined or unlined pit in the ground (see 6.8.7 for information on pit linings) with a sealed cover. The cover is normally constructed from reinforced concrete and has a small hole left in the middle. A tube or pipe rises vertically from the hole. This can be made from steel, asbestos or uPVC pipe and should be approximately 200mm in diameter (depending on the size of sharps containers). This is designed to prevent anyone from reaching inside the pit. Sharps containers (such as that in Figure 8.2) can be dropped down the tube into the pit below. Once the pit is full lime can be poured over the waste and the aperture should be sealed; a replacement pit should then be constructed.

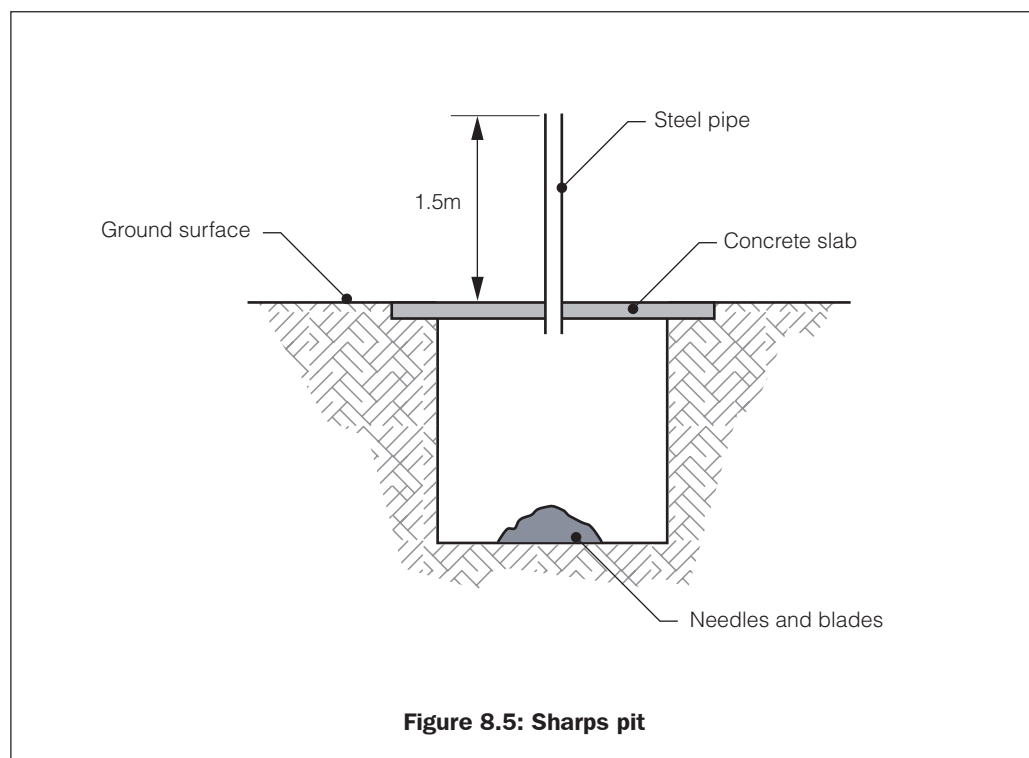

WASTE MANAGEMENT AT MEDICAL CENTRES

Advantages: The pit is cheap and easy to construct; simple to understand; and easy to replace.

Constraints: Sharps containers may be attractive for alternative uses; and staff must be properly trained.



Sealed sharps pit, Zambia

8.5.4 Placenta burial pits

Where appropriate, covered pits can be provided for the disposal of placentas and other pathological wastes. In some cultures, it is normal practice for the family of the newborn to take the placenta home, whilst in other cultures the family prefer to bury it themselves. Where the latter is the case a designated area for burial should be provided where access by animals is prevented. In all cases the mother and her family should be consulted and their wishes respected.

8.6 Intervention levels

The risks posed by medical waste are so significant that in general intervention options are identical for immediate, short-term and long-term. However, basic immediate measures concerning segregation, transportation and disposal can gradually be improved and upgraded in later stages of an emergency. Table 8.3 gives recommended interventions for different emergency scenarios.

EMERGENCY SANITATION

Table 8.3. Recommended interventions for different scenarios

<i>Scenarios and recommended interventions</i>	<i>The affected population go through a transit camp immediately after a disaster</i>	<i>The affected population remain in a temporary location for up to six months</i>	<i>The affected population stay in the affected area immediately after a disaster</i>	<i>The affected population move to a new area and are likely to remain for more than a year</i>
Immediate action	<ul style="list-style-type: none"> ■ Clearing of scattered waste ■ Burning and burial of waste on site ■ Temporary pit for general waste and ashes ■ Temporary containers for segregated waste ■ Temporary sharps pit ■ Temporary burner 			
Short-term measure	<ul style="list-style-type: none"> ■ Sealed containers for segregated waste ■ Pit for general waste ■ Off-site disposal for general waste ■ Temporary incinerator/burner ■ Sealed sharps pit 			
Long-term measure			<ul style="list-style-type: none"> ■ Sealed containers for segregated waste ■ Pit for general waste ■ Off-site disposal for general waste ■ Permanent incinerator ■ Sealed sharps pit ■ On-site sanitary landfill 	

8.7 Education and training

A key aspect of the management of waste from medical centres is appropriate education of all those who may come into contact with waste and training of all those who are responsible for handling waste. Segregation, storage and transportation procedures should be well known among all medical and related staff. Signs and colour-coding should be used extensively within all medical facilities. A senior member of medical or sanitation staff should be given overall responsibility for the management of the system and the following groups should undergo appropriate training in waste management:

- Doctors
- Nurses

- Laboratory staff
- Cleaners
- Hygiene promoters
- Medical support staff

8.8 Key recommendations for waste management

The following key recommendations for waste management at medical centres were identified by Appleton and Ali (2000):

- Improve practices at all stages of the waste stream and do not focus on one stage only, for example final treatment.
- Separate the different types of waste at source: in particular keep infectious waste, pathological waste, sharps and chemical waste from being mixed with non-hazardous material.
- The separation and sale of reusable but non-hazardous materials such as paper, plastic and glass can successfully take place under controlled conditions if the waste is separated at source.
- Be prepared to improve the systems incrementally rather than look to ‘once and for all’ solutions such as incineration of all waste from the outset. Small steps can have significant impacts.
- Establish a distinct management responsibility for dealing with the waste generated.
- Create a dedicated budget for waste management.
- Provide all staff with training on handling waste.
- Work out detailed procedures for storage, handling, transfer and disposal of waste according to its characteristics and potential risks.

References and further reading

- Adams, John (1999) *Managing Water Supply and Sanitation in Emergencies*. Oxfam: Oxford.
- Appleton, Jenny and Ali, Mansoor (2000) *Healthcare or Health Risks? Risks from Healthcare Waste to the Poor*. WELL Study
- Cairncross, S. and Feachem, R. (1993) *Environmental Health Engineering in the Tropics: An introductory text*. John Wiley & Sons, Chichester.
- Coad, A. (1992), *Managing Medical Wastes in Developing Countries: Report on a Consultation on Medical Wastes Management in Developing Countries*. WHO: Geneva.
- Davis, Jan and Lambert, Robert (1996) *Engineering in Emergencies: A practical guide for relief workers*. RedR / IT Publications: London.
- Médecins Sans Frontières (1994) *Public Health Engineering in Emergency Situation*. Médecins Sans Frontières, Paris.
- Reed, R. and Dean, P.T. (1994) Recommended methods for the disposal of sanitary wastes from temporary field medical facilities. *Disasters* Vol 18, No 4.
- Pruss, A., Giroult, E. and Rushbrook, P. (Editors) (1999) *Safe Management of Wastes from Health-care Activities*. WHO: Geneva.
- WHO (1999) *Guidelines for Safe Disposal of Unwanted Pharmaceuticals in and after Emergencies*. WHO: Geneva.

Chapter 9

Disposal of dead bodies

In many emergency situations, especially in the immediate aftermath of a natural disaster such as an earthquake or cyclone, there may be many dead bodies that require appropriate disposal. Despite many myths and rumours to the contrary, exposure to dead human bodies is **not** in itself a serious health hazard except in specific cases. For this reason, bodies should as far as possible be handled and buried or cremated by the families of the dead people, in ways which are as close as possible to their normal cultural and religious practices. Mass cremation or mass burial should be avoided if possible.

9.1 Associated risks: Myths and realities

In many scenarios, the management of corpses is based on the false belief that they represent an epidemic hazard if not immediately buried or burned. In fact, in the vast majority of situations, the health hazard associated with dead bodies is negligible. Indeed, WEDC field assessments by the authors have repeatedly shown that disposal of the dead presents the lowest health hazard of all the sanitation sectors covered in this book.

'The myth that dead bodies cause a major risk of disease, as reiterated in all large natural disasters..., is just that, a myth.' (Goyet, 1999)

The presence of a large number of corpses following a disaster is likely to cause fear and uncertainty among the affected population. It is essential that this is not exacerbated by inaccurate information linking dead bodies and infectious disease. The primary problems and risks associated with dead bodies are social and political, not health-related.

9.1.1 Infectious diseases

One of the most common myths associated with disasters is that dead bodies are responsible for epidemics. In fact, a relationship between corpses and epidemics has never been scientifically demonstrated or reported (WHO, 1999). If people have died from the direct effects of war, famine or natural disaster then the risk of infectious disease is negligible.

Where the person has actually died from typhus or plague, the body may be infested with infected lice or fleas which can transmit these diseases to other individuals (WHO, 2001).

Likewise, a person who has died from cholera or ebola may pose considerable health hazards to those in direct contact with the corpse. However, such situations are not common.

9.1.2 Water-related diseases

Contamination of water sources and the resulting transmission of infection may occur in a very limited number of cases when bodies are in contact with the water system and transmit gastro-enteritis.

Diseases transmitted by mosquitoes such as malaria and dengue fever are not associated with the presence of dead bodies.

9.1.3 Pollution

The pollution of groundwater by buried corpses is rare although burial sites do produce dioxin and furan emissions which are potentially highly hazardous to humans. Possible health effects caused by exposure to dioxins include skin diseases and cancer. There are also some concerns about embalming fluids, such as formaldehyde, entering the groundwater. The risks of this are slight, however, since 4 per cent formaldehyde solution is usually used and most of this degrades in the body and soil before reaching the water table.

Air pollution can be considerable where large funeral pyres are built; this produces smoke hazards and air-borne dioxins.

9.1.4 Mental health

Perhaps the biggest risk associated with dead bodies is that to the mental health of the affected population. This includes the trauma of searching for survivors and retrieving corpses, as well as the unintended social impact of the precipitous and unceremonious disposal of bodies.

Observation of the dead can be deeply disturbing and the odours produced by decomposing corpses may be even more so. It is therefore important that corpses are collected quickly and morgue facilities are provided if bodies cannot be buried or cremated fairly rapidly.

In most situations, the cultural obligation to take care of dead bodies and the mental health consequences of open mass graves and uncollected corpses should be given priority over potential disease transmission.

9.2 Medical epidemics

Medical epidemics where corpses play a key role in disease transmission are relatively rare, even in emergency situations where the population is suffering from widespread malnutrition, or where water supply and sanitation facilities are poor. Epidemics are not **caused** by undisposed corpses; however, where an epidemic already exists, the disposal of the dead may become a more hazardous issue.

9.2.1 Cholera

Cholera is an acute intestinal infection which causes watery diarrhoea and can lead quickly to severe dehydration and death. Despite conflicting rumours, transmission through person-to-person contact is rare (WHO, 2000). The most common pathways for infection are the ingestion of contaminated drinking water or food contaminated during or after preparation.

DISPOSAL OF DEAD BODIES

In general, dead bodies do not usually interfere with the transmission of the disease. However, funerals for people (who die of cholera or any other cause) in a community affected by cholera can contribute to the spread of an epidemic. Funerals may bring people into infected areas from which they can carry the cholera organism elsewhere. For this reason, it may be necessary to limit funeral gatherings, ritual washing of the dead and funeral feasts. Burial or cremation should take place soon after death and near the place of death, to reduce the spread of infection.

Those who prepare the body of a cholera patient for burial can be exposed to high concentrations of cholera vibrios (WHO, 1993). It is important that these people are not responsible for the preparation of funeral food since this may increase the risk of transmission of infection. If this cannot be avoided then meticulous handwashing with soap and water is essential prior to handling food.

Despite these measures, appropriate disposal of the dead is not the main factor in controlling a cholera outbreak. Better excreta disposal systems, improved hygiene practice (especially concerning food) and increased access to safe drinking water are essential for minimising the transmission of cholera.

9.2.2 Ebola

Ebola Hemorrhagic Fever (Ebola HF) is a rare but severe and often fatal disease caused by the Ebola virus. It typically appears in sporadic outbreaks, usually within a health-care setting. The disease can be transmitted through body fluids or secretions, and using the same water. It is a brutal virus and, while inside the body, it can live easily in all fluids such as blood, spit, sputum, vomit, faeces and semen. Once outside the body, Ebola is quite fragile. It can easily be killed with the use of water and soap, but if nothing is done, for instance if a drop of blood is not cleaned, then the virus can remain much longer than the HIV virus (Médecins Sans Frontières, 2001).

Where an Ebola epidemic occurs, it is essential that high levels of awareness are promoted within the community, and that those who work with the sufferers, whether the patients be alive or dead, have the highest level of protection.

Where dead bodies are traditionally bathed by the family prior to burial this may actually assist the spread of the disease. In such cases it may be necessary to avoid traditional ceremonies and explain the risks to the bereaved family.

9.2.3 Typhus and plague

Bodies of people who have died from typhus or plague are likely to be infested with fleas or lice that can spread these diseases. It is recommended that handling of such bodies is conducted by trained medical staff only, that they are provided with appropriate protective clothing such as gloves, overalls and face masks, and that all equipment is thoroughly disinfected after use. Traditional bathing by family members should again be prevented if possible. It is advised that bodies are placed in body bags (if available) prior to burial but contact with corpses should be minimised and embalming should not be carried out (Healing et al., 1995)

9.3 Cultural practices and needs

In general, the cultural practices and needs of the families of the deceased should be given priority over public health concerns. The process of mourning and burial or cremation will be highly significant and emotional to the family and friends of the dead person. It is important that relief workers take time to absorb the wishes and traditions of different groups within the affected population. Misunderstandings between aid personnel and families may result in unnecessary friction.

Cemeteries or cremation facilities should be planned for and provided early on in an emergency, in consultation with members of the affected population. Lack of acceptable funeral facilities and procedures may leave social issues unresolved, which may contribute to the overall grief of those involved, causing rather than reducing trauma. The collection, disposal, burial and/or cremation of corpses requires important human and material resources which should be allocated to the family and friends of the deceased.

People often expend scarce resources on funeral rites and graves, and where this is their wish it should be respected. In emergencies following conflict or genocide, memorials may help to heal wounds, and energies poured into this may speed up the emotional and physical recovery of the community.

In some communities 'burial societies' responsible for burial of the dead may be formed among the affected population; these should be promoted and used where possible.

9.4 Mortuary service and handling of the dead

9.4.1 Morgues

In some situations it may be appropriate for the family of the deceased to keep the body after death to conduct a traditional wake prior to burial or cremation. In the immediate stage of an emergency where there are many casualties, or where there is an epidemic, it may be necessary to set up a mortuary. Ideally, a morgue should consist of:

- a reception room;
- a viewing room;
- a storage chamber for bodies not suitable for viewing; and
- a room for records and storage of personal effects.

Ideally, bodies should be stored at 4°C but this is rarely possible.

9.4.2 Records

Provision should be made for monitoring deaths and funerals to record mortality data and to issue death certificates where appropriate. Depending on circumstances, the recovery and identification of the bodies of family members may be the primary concern of survivors.

In some situations, deaths may not be reported and bodies may be secretly buried to prevent reduction in food rations and other relief items.

When those being buried are the victims of violence, forensic issues should be considered (Sphere Project, 1999).

DISPOSAL OF DEAD BODIES

9.4.3 Body dressing

Depending on local custom, it may be necessary to provide coffins, cloth or other materials for families to wrap their dead before burial or cremation. Blankets and sleeping mats can also be used if cloth is not available. In epidemics sealed body bags should be provided where possible.

9.4.4 Disinfection

In epidemic situations, 'disinfection' with lime (or chloride of lime) is often promoted. This is largely superficial, does little to remove infectious pathogens, and is hazardous to those using it (Healing et al., 1995). The provision of appropriate protective clothing to those handling the dead is likely to be more effective in most cases. Where appropriate, chlorine solution or medical disinfectants can be used by trained people to disinfect areas which have been in contact with infected corpses.

9.4.5 Protective clothing

Gloves and overalls should be provided to those handling dead bodies from epidemics and bodies with open wounds. In most other situations the family will take care of the corpse and will not require special clothing. Health workers in contact with dead bodies should be encouraged to wash themselves thoroughly with disinfectant soap, especially in epidemics or where there is a high prevalence of HIV and open wounds.

9.4.6 Transportation

The most common mode of transport to the burial or cremation site is for the body to be carried in procession by the family group. Only in exceptional cases, such as epidemics, should it be necessary for corpses to be transported by motor vehicle. Where this is the case vehicles should be thoroughly cleaned and disinfected after use by spraying with disinfectant. Taxis or wheelbarrows may sometimes be used and these should be disinfected immediately, prior to leaving the site.

9.4.7 Mass management

In the rare cases where the mass management of dead bodies is required appropriate teams will need to be set up to collect, store and bury or cremate bodies. Record keeping and identification of family members is likely to be complex and time-consuming in such situations, especially in the immediate aftermath of a large scale humanitarian disaster.

9.5 Burial

Burial is the preferred disposal method in general and should be used unless the customs and wishes of the family dictate otherwise.

9.5.1 Burial sites/cemeteries

Burial sites should be determined through consultation with the affected community and local authorities. Soil conditions, water table level and available space must be considered in their selection.

Graveyards should be located at least 50m from groundwater sources used for drinking water and at least 500m from the nearest habitable building. Ideally, an area of at least 1500m² per ten thousand population is required.

EMERGENCY SANITATION

The use of the cemetery should be carefully managed. Where there are different religious groups within the affected population it may be necessary to provide separate burial areas. Depending on local custom cement for grave markers may also be required.

9.5.2 Burial depth

It is important that bodies are buried at sufficient depth to eliminate odours and prevent disturbance by carrion and dogs. A covering of soil of at least 1.0m is recommended.

The base of any grave should be at least 1.5m above the groundwater table where possible, to minimise contamination. In general, it is not necessary to line graves unless there is an especially high risk of contamination.

9.6 Cremation

Health considerations alone provide no justification for cremation and this should only be conducted where it is the traditional or preferred method among the relevant family members.

9.6.1 Fuel

The primary constraint concerning cremation is the availability of fuel. It is estimated that a single traditional cremation in India requires approximately 300kg of firewood (TERI, 2001). It is essential that adequate fuel can be obtained without significant detrimental effect on the local environment. It is also important that those responsible for cremation are experienced, to ensure that corpses are cremated at sufficient temperature.

9.6.2 Smoke pollution

Cremation can cause extreme smoke pollution which may contain harmful dioxins, especially where large numbers of bodies are cremated at the same time. Mass funeral pyres should be avoided and cremation sites should be carefully located at least 500m downwind of habitable dwellings.

9.7 Key recommendations for the disposal of the dead

The following are key recommendations for the disposal of the dead in emergency situations:

- Give priority to the living over the dead (provide sanitation facilities for the survivors first).
- Promote the identification and tagging of corpses.
- Provide accurate information concerning the risks associated with corpses.
- Do not promote mass cremation of bodies.
- Do not support mass burial of unidentified bodies in large graves.
- Conserve fuel and resources.
- **Respect the wishes and social customs of the families.**

References and further reading

- Adams, John (1999) *Managing Water Supply and Sanitation in Emergencies*. Oxfam: Oxford.
- Davis, Jan and Lambert, Robert (1996) *Engineering in Emergencies: A practical guide for relief workers*. RedR / IT Publications: London.
- CDC (2000) *Viral Hemorrhagic Fevers: Fact sheets*. Centres for Disease Control and Prevention: Washington D.C. (<http://www.cdc.gov>)
- Clark, D.H., Nicholls, J. & Gillespie, F (1992) Planning for Mortuary Facilities in Mass Disasters, *Disaster Management* 4(2), pp 98-102.
- Goyet, Claude d.V.d. (1999) *Stop Propagating Disaster Myths*. Pan American Health Organisation: Washington D.C. (<http://www.paho.org>)
- Healing, T.D., Hoffman, P.N. and Young, S.E.J. (1995) The Infection Hazards of Human Cadavers. *Communicable Disease Report*, Vol 5, Review No 5.
- Médecins Sans Frontières (1994) *Public Health Engineering in Emergency Situation*. Médecins Sans Frontières: Paris.
- Médecins Sans Frontières (1997) *Refugee Health: An approach to emergency situations*. Médecins Sans Frontières / Macmillan Education Ltd.: London and Basingstoke.
- MSF (2001) Médecins Sans Frontières. <<http://www.msf.org>> (12 April 2001)
- PAHO (1993) *Manual de Manejo de Cadaveres en Situaciones de Desastre*. Organización Panamericana de la Salud: Washington.
- TERI (2001) Tata Energy Research Institute. <<http://www.teriin.org>> (November 2001)
- UNCHR (2000) *Handbook for Emergencies*. UNHCR: Geneva.
- WHO (1993) *Guidelines for Cholera Control*. WHO: Geneva.
- WHO (1999) *Public Health Consequences of Earthquakes*. Technical Briefing Note, WHO: Geneva.
- WHO (2000) *Cholera*. Fact Sheet N.107, WHO: Geneva. (<http://www.who.int>)
- WHO (2001) *Mortuary Service and Handling of the Dead*. WHO, India. <<http://www.whoindia.org>> (12 April 2001)
- Wilson, K. and B. Harrell-Bond (1990) 'Dealing with dying', *Refugee Participation Network Newsletter (RPN)* No.9, August 1990. Oxford.

Chapter 10

Wastewater management

Within the scope of this book, wastewater is considered to mean sullage, i.e. waste water that does not contain excreta or toilet wastes, except those arising from soiled bodies and clothing (Cairncross and Feachem, 1983). Therefore for the purposes of this Chapter, the term wastewater does not include sewage or rainwater.

10.1 Associated risks

Although wastewater may not pose such obvious health risks as excreta or medical waste, there are several indirect risks which should be considered. It is necessary to provide appropriate wastewater management systems in order to:

- minimise breeding grounds for water-related insect vectors (e.g. mosquitoes);
- prevent erosion of shelters and facilities;
- prevent wastewater entering pit latrines or solid waste pits;
- prevent pollution of surface or ground water sources; and
- allow safe access to shelters and facilities.

Inappropriate systems, as well as lack of intervention, can increase some of these risks rather than reduce them. Systems involving standing water may inadvertently increase mosquito populations and infiltration systems may lead to the pollution of groundwater sources.

Although the quality of the wastewater may not pose a direct risk to humans (assuming it is not ingested), where wastewater intercepts excreta or refuse disposal sites the risk of disease transmission can increase greatly. Wastewater which spreads toilet wastes or refuse will also spread the likelihood of direct human contact with disease-causing pathogens. This is especially the case where children play or people bathe in the watercourse into which the wastewater is disposed of.

Wastewater can also pose considerable environmental risks, especially where it carries significant components of oil or detergent-based products, and where final disposal sites become stagnant. For this reason it is sometimes necessary to treat wastewater prior to disposal in the environment (see 10.4).

10.2 Sources and types of wastewater

The most common sources of wastewater are:

- water taps;
- kitchens/feeding centres;
- laundries;
- bathing areas; and
- clinics.

In most refugee camps, water is carried to dwellings. Where this is the case, volumes of domestic wastewater are generally low and well dispersed, and hence do not pose any serious health hazard. It is still important, however, that people are aware of where and where not to dispose of their domestic wastewater.

Where waterpoints are used for water collection only, the volumes of wastewater produced are likely to be low, resulting from the rinsing of collection vessels and spillage only. The rate of wastewater generation will increase greatly where waterpoints are also used for laundry purposes. For this reason, it is recommended that specified laundry areas are provided with disposal systems able to cope with the quantity of wastewater produced.

In general, wastewater has high turbidity and high values of total suspended solids (TSS); it may also contain oils, detergents and food substances. Total and faecal coliforms may sometimes be present, especially where water has been used for laundry purposes.

10.3 Selection criteria

In determining appropriate interventions for wastewater management there are several important factors to consider:

- Ground conditions
- Groundwater level
- Topography
- Location and type of water sources
- Quantity and quality of wastewater generated
- Climatic conditions
- Socio-cultural considerations

10.3.1 Ground conditions

One of the key factors in determining an appropriate technology choice for wastewater disposal is the condition of the ground or soil. Infiltration techniques are often adopted but may not always be appropriate. In some instances, ineffective soakpits may pose higher health risks (e.g. as potential mosquito breeding sites) than no intervention at all.

A soakpit or infiltration trench will only be effective if wastewater is able to percolate into the soil. Section 4.3.2 gives guideline infiltration rates for different types of soil and how to identify these soils. Where there is any doubt concerning whether infiltration will work, it is good practice to determine the approximate permeability of the ground by conducting a simple infiltration test.

WASTEWATER MANAGEMENT

10.3.2 Groundwater level

The groundwater level will also influence whether infiltration can be used, and seasonal variations in this must be considered. Where the water table is close to the ground surface, infiltration is likely to be severely limited. Soak pits or infiltration trenches that intercept the water table will fill rapidly and are unlikely to cope with large volumes of wastewater. In addition, the risk of groundwater pollution will increase with the height of the groundwater level.

10.3.3 Location and type of water sources

In all cases, it should be a priority to prevent contamination of clean drinking-water sources with wastewater. It is therefore important that the locations of all existing, or potential, water supply sources are taken into account when selecting and designing wastewater management systems. Conversely, drainage possibilities should be considered when selecting and designing water distribution points.

Where wastewater is discharged into surface waters, it is important that this is downstream of any water supply intakes. This will prevent increased water treatment requirements. It is also important to consider downstream water use and what the effects of effluent discharge will have on this.

Where groundwater is used as a water source, several factors should be considered if wastewater is disposed of by infiltration. Although the ground will act as a filter and remove impurities as the wastewater travels to the aquifer, the following safety measures should be taken:

- Soakpits or infiltration trenches should be at least 30m horizontal distance from any groundwater source (e.g. well, borehole).
- Disposal sites should be downhill of groundwater sources where possible.
- The base of any soakpit should be at least 1.5m above the water table.
- Where wastewater contains a high oil component, water should be treated prior to disposal.

10.3.4 Topography

The topography of the affected site will be a key factor in determining whether surface drainage techniques can be adopted. It is rare to find a site that is completely flat, although where this is the case, or nearly so, surface drainage becomes almost impossible. In general, a minimum gradient of 1 in 200 is recommended for the transport of wastewater in earth drainage ditches (Davis and Lambert, 1995). Where drainage channels have to circumnavigate natural obstacles, such as mounds or hillocks, this may increase labour time and costs considerably.

10.3.5 Quantity and quality of wastewater generated

The volume of wastewater generated will also influence the technology choice made. Where there are only small quantities of wastewater, infiltration may be appropriate even in low-permeability soils, or these may be removed rapidly through evaporation. Where larger volumes are involved, disposal systems must be selected and sized accordingly. Existing systems may become inappropriate if water use increases greatly, and will need upgrading or replacing. Guideline wastewater generation rates for public institutions are as follows:

EMERGENCY SANITATION

- Field hospital: 55 litres/person/day
- Cholera treatment centre: 100 litres/person/day
- Feeding centre: 25 litres/person/day
- Out-patients clinic: 100 litres/day (total)

Whilst the quality of wastewater is not of major importance in most cases, with low numbers of pathogens, this should also be considered. Wastewater from water collection points is unlikely to require treatment, whilst that from kitchens or hospitals probably will.

10.3.6 Climatic conditions

Climatic conditions will also affect intervention selection. In hot, dry climates evaporation or irrigation use of wastewater may be viable. In wetter climates the volume of rainfall must be considered, and may even be used in removing wastewater.

In colder climates the possibility of drainage pipes or systems freezing should not be overlooked.

10.3.7 Socio-cultural considerations

Although wastewater management in general is a less sensitive issue than excreta disposal or hygiene promotion, socio-cultural aspects should also be considered. Where surface drainage channels pass through residential areas this may create temptation for people to use wastewater for domestic purposes, and it may be difficult to deter them from doing so.

Cultural practice and tradition, in terms of water use, may also influence the volume of water used and wastewater generated. This may also affect when wastewater is produced, for example if large numbers of people bathe or do laundry at a particular time of day.

10.4 Technology choice

The immediate action options for wastewater management are generally the same as those for longer term intervention. It may be appropriate, however, to implement a simple option in the emergency phase and develop this further at a later date. Whenever possible, wastewater should be disposed of close to the point of origin. The simplest method, where possible, is to divert wastewater to local watercourses. The most common method in emergency situations is probably infiltration. The technology choices included here are:

- Soakaways or soakpits
- Diversion to natural drainage
- Diversion to man-made drainage
- Infiltration trenches
- Bucket basins
- Evaporation pans
- Evapotranspiration beds
- Irrigation use

WASTEWATER MANAGEMENT

10.4.1 Soakpits

A soakpit, or soakaway, is simply an excavation in the ground which facilitates the percolation of wastewater into the surrounding soil. As well as wastewater from the sources outlined above, a soakpit can also be used to dispose of the effluent from a septic tank or aquaprivy. By spreading the effluent over a sufficiently large soil area the water is treated and absorbed efficiently. Depending on the wastewater quality, a film of organic slime may develop on the walls of the soakpit and just inside the soil (Figure 10.1). As the wastewater passes through the slime it traps suspended particles and the organisms which live in the slime feed off the waste products in the effluent. If the flow is too high, the slime layer will grow until it completely blocks the soil, preventing any further flow of wastewater.

The treatment process is much more efficient if the soil is kept well oxygenated. This requires the soil to be alternately saturated with effluent and dried to allow the entry of air. In well-designed systems this happens naturally because of the daily variations in flow. The process is far less efficient in constantly saturated conditions such as below the water table.

Whether a soakpit will function or not depends primarily on the permeability of the soil. Soil pores may become clogged with time and this can reduce the infiltration capacity of a particular soakpit. Seasonal variations in the water table can also affect the performance greatly, and a soakpit which works perfectly in the dry season may overflow at other times of year.

10

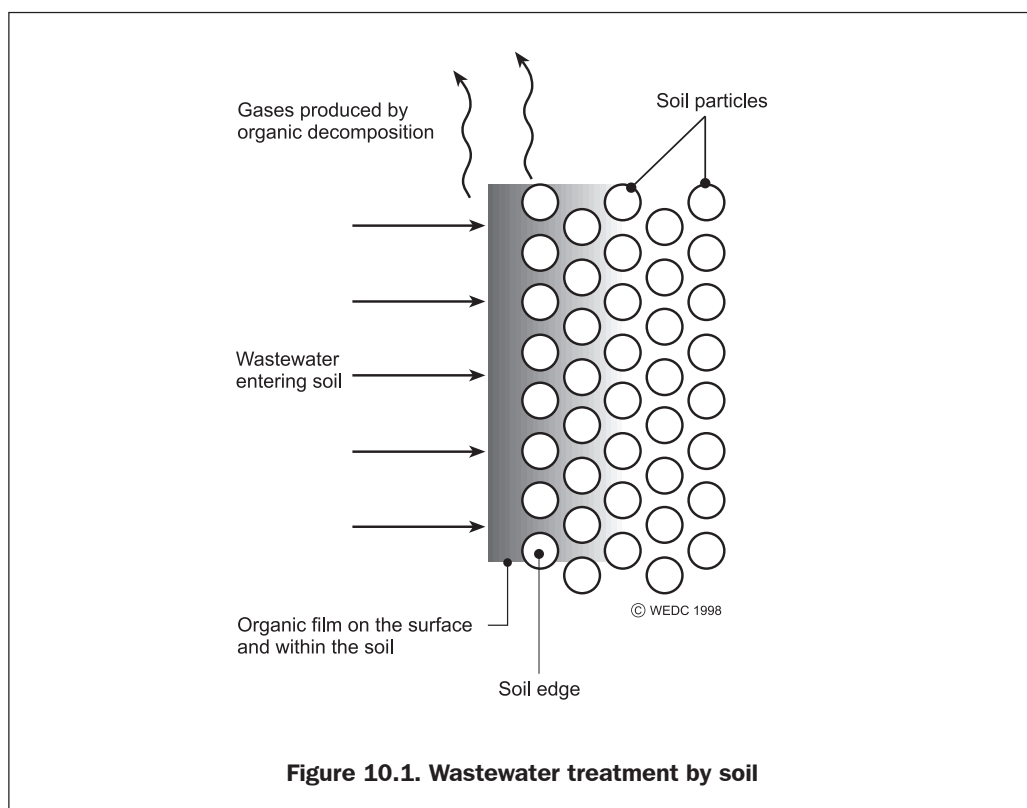

Figure 10.1. Wastewater treatment by soil

EMERGENCY SANITATION

Soakpits are commonly between 2 and 5m deep and 1 to 2.5m in diameter. Wastewater entering the pit may soak into the surrounding soil through the sides and base of the pit. If the water has a high solids content, however, the base of the pit will quickly become blocked with silt and sludge. Where this occurs infiltration will only take place through the pit walls, therefore the base area is ignored when designing soakpits.

Most pits in emergency situations are not lined but filled with large stones, blocks, bricks, etc. (Figure 10.2). This fill is to support the pit walls and the cover. It does not play any part in the treatment of wastewater and its volume should be deducted when calculating pit volumes.

Advantages: Soakpits are easy and relatively quick to construct; and can be used on flat sites.

Constraints: They are only appropriate in permeable ground conditions; and can only cope with a limited volume of wastewater.

10

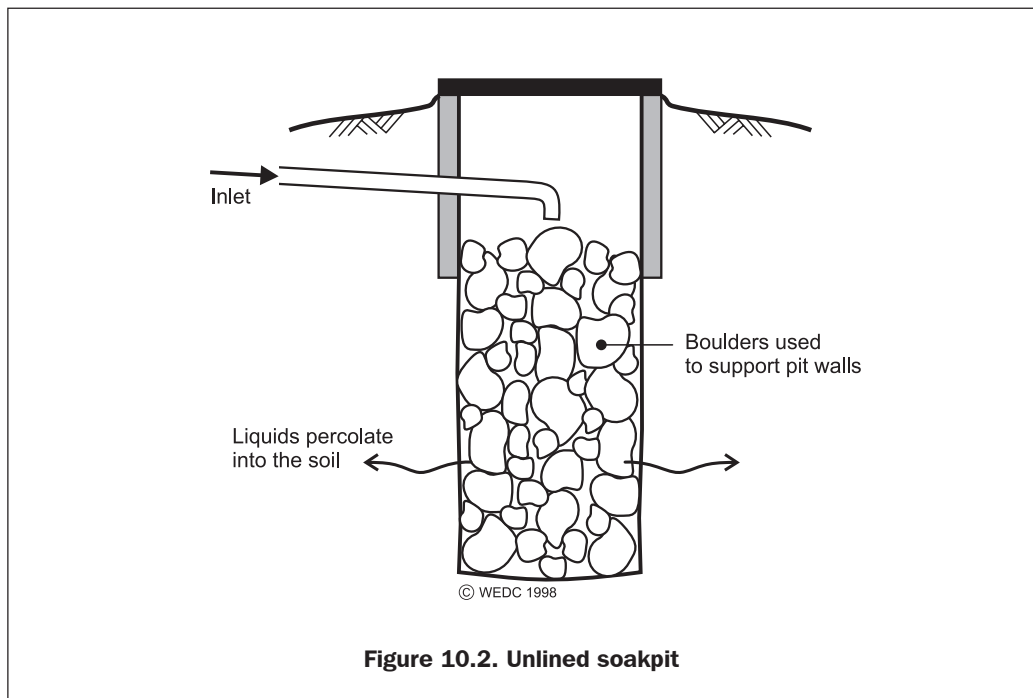

WASTEWATER MANAGEMENT

Alternatively, the pit can be lined (Figure 10.3). Any lining must be porous so that the wastewater can reach the soil surface. The top 0.5m of any pit must have a sealed lining in order to prevent the infiltration of rainwater.

The size of a soakpit depends on the volume of liquid to be disposed of and the type of soil in which the pit is excavated. It may be calculated by using the following process:

1. Calculate the surface area of pit wall required for infiltrating the wastewater:
Pit wall area (m²) = daily wastewater flow (litres) ÷ soil infiltration rate (Table 4.3)
2. Choose a pit diameter.
3. Calculate the depth of pit required to dispose of all the liquids:
Depth of pit required = pit wall area ÷ (π x pit diameter)
4. Add 0.5m (lined depth) to calculate the total pit depth needed.

10

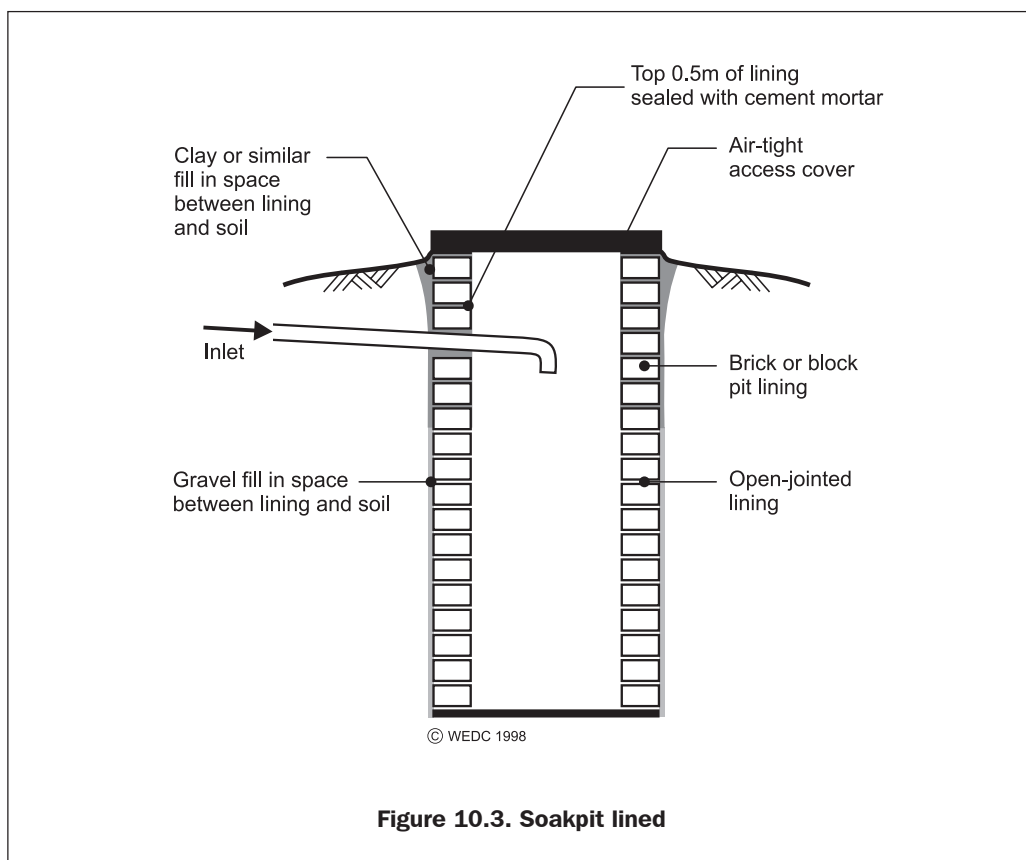

EMERGENCY SANITATION

Worked example: A soakpit is required to dispose of 500 litres per day in a sandy loam soil (infiltration rate = 25 litres/m²/day: see Table 4.3). There is space for a pit of 2m diameter only.

Pit wall area = wastewater flow ÷ infiltration rate = 500 ÷ 25 = 20m²

Depth of pit = pit wall area ÷ (π x pit diameter) = 20 ÷ 2π = 3.2m

Total depth of pit = depth of pit + 0.5m = 3.2 + 0.5 = **3.7m**

Note: Wastewater from large institutions, such as hospitals, is likely to be far too great in volume to be disposed of in a single soakpit.



Poorly designed soakpit, Tanzania

WASTEWATER MANAGEMENT

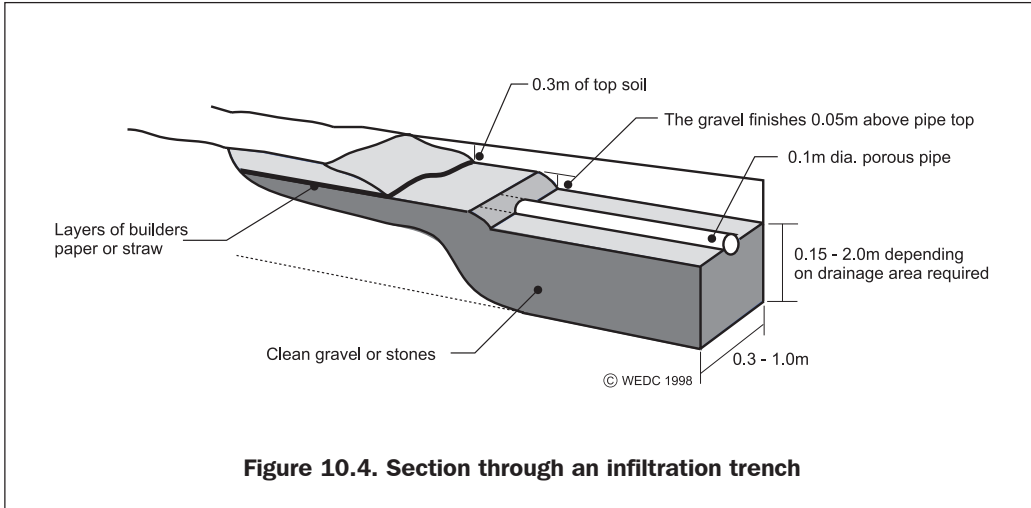

10

10.4.2 Infiltration trenches

An infiltration trench is a variation on a soakpit. Its advantages are that it provides a higher surface area for the volume of soil excavated, and it uses the upper soil layers which tend to be more porous. Instead of directly entering a pit, the wastewater is dispersed by pipes along a series of trenches that have been filled with coarse gravel (Figure 10.4).

The pipes are porous so that the wastewater can seep out into the surrounding gravel, and from there, through the walls of the trench into the soil. Pipes can be made from porous materials such as concrete made without sand, or small holes or slots can be cut in the walls. Pipes are laid horizontally to allow the water to be distributed evenly along the whole length. The size of the pipe depends on the volume of flow but for most situations 100mm diameter is sufficient.

The top of the pipe is covered with a layer of paper, straw or porous plastic sheeting. This allows air to enter the trench and gases to escape but prevents the topsoil from mixing with the gravel and blocking the trench.

Trenches should be as narrow as possible since it is only the side walls that absorb the effluent. Generally the trench should be 300-600mm wide, and a depth of about 1m below the bottom of the distribution pipe.

Advantages: Trenches are easy and relatively quick to construct; can be used on flat sites; and can cope with a greater amount of wastewater than a soakpit of the same volume.

Constraints: They are only appropriate in permeable ground conditions.

EMERGENCY SANITATION

The length of an infiltration trench can be calculated by using the following process:

1. Calculate the surface area of trench wall required for infiltrating the wastewater:
Infiltration area (m²) = daily wastewater flow (litres) ÷ soil infiltration rate
2. Calculate the total length of side wall required:
Total length of side wall = infiltration area ÷ trench depth below distribution pipe
3. The length of trench required is half of the total length of side wall.

Note: Ideally, the infiltration rate should be measured at a number of places in the drainage area, since soil texture changes very quickly. Details of how to do this can be found in Chapter 4.

10.4.3 Natural drainage

If natural drainage can be used to dispose of wastewater to flowing streams or rivers then this should be used. Care must be taken to ensure that this occurs downstream of water sources, and in general a slope of at least 1 in 200 is required for water to drain effectively in earth channels. Lined drainage channels (e.g. concrete) are likely to be effective on lesser slopes, but are costly and time consuming to construct, and unsuitable in most emergency situations.

Wastewater with high organic content, including laundry wastewater, should not be diverted to stagnant ponds, where it may become anaerobic and offensive. Discharging large volumes of wastewater to small watercourses may also cause periodic overflowing, leading to pooling of stagnant water.

Advantages: A minimal amount of construction work is required; and there are negligible physical effects on landscape.

Constraints: It is rarely possible; and may inadvertently pollute watercourses.

10.4.4 Man-made drainage

In some sites it may be appropriate to construct drainage channels cutting through natural obstacles, such as earth mounds or hillocks, to reach an existing water course. This is likely to be arduous work, expensive and time consuming. However, it may be the only option where infiltration is impossible and where natural drainage leads to stagnant or hazardous conditions.

Advantages: It may be the only option in impermeable sites with small gradients.

Constraints: It is expensive and time consuming to construct; and may have a large impact on the surrounding landscape.

WASTEWATER MANAGEMENT

10.4.5 Evaporation pans

An evaporation pan is a shallow pond which holds water and allows it to evaporate (Figure 10.5). Evaporation rates depend upon solar radiation, temperature, humidity and windspeed. Wastewater can be disposed of to evaporation pans in hot, dry conditions where evaporation rates considerably exceed rainfall rates for the operating period.

In general, large areas of land are required for evaporation pans to work successfully. Even a high evaporation rate of 5mm/day requires a surface area of 200m² per cubic metre of liquid per day (Davis and Lambert, 1996). Assuming that there is no infiltration of water into the soil, the area required can be estimated by using the following equation:

$$\text{Area (m}^2\text{)} = \frac{\text{Volume of wastewater per day (m}^3\text{)} \times 1000}{\text{Evaporation rate (mm/day)}}$$

Evaporation rates are difficult to determine and meteorological instruments are required. Measuring direct evaporation of water from an evaporimeter is the simplest method although this still requires the collection of additional rainfall data. Alternatively, evaporation can be estimated mathematically from measured climatic factors (i.e. air temperature, humidity, sunshine and windspeed). Information regarding how to conduct such measurements is contained in most field hydrology textbooks but the best solution is to obtain data from nearby weather stations (where possible). In general, evaporation pans should only be used for wastewater disposal where there is a mean evaporation rate of at least 4mm/day, where rainfall is negligible and where there is no viable alternative.

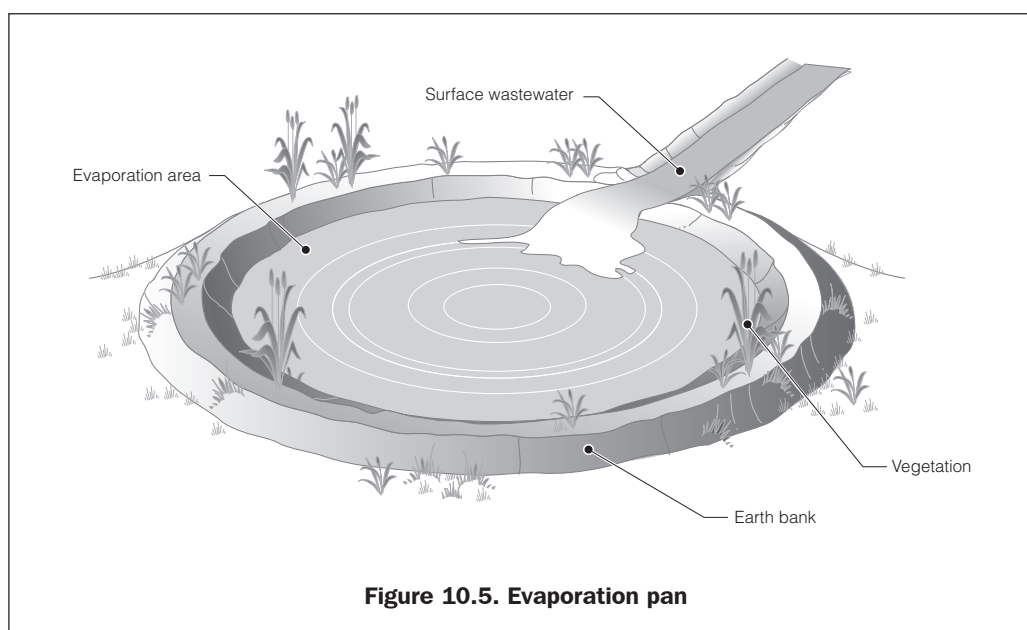

EMERGENCY SANITATION

Pans should be sited far away from habitation to limit water-related insect hazards (e.g. mosquitoes) and require careful management if they are to be effective. Provision will need to be made for managing possible overflow during periods of rainfall and regular maintenance is likely to be necessary.

Advantages: Evaporation pans are suitable in arid conditions where other disposal methods, such as infiltration, are inappropriate.

Constraints: They may encourage mosquitoes, flies, etc; and large areas are required.

10.4.6 Evaporation and evapotranspiration beds

Evaporation beds can be used where infiltration methods cannot, but are only suited to dry, arid climates. This method relies on capillary action to draw water to the surface of shallow sand beds, where it is evaporated to the atmosphere. An improvement on this is the evapotranspiration bed (Figure 10.6) which increases the rate of water removal by planting vegetation in the bed to draw up water and encourage transpiration.

Solid materials should be removed from wastewater before it is allowed to enter the sand bed through a system of distribution pipes. The perforated pipes should be about 1m apart and surrounded by uniform-sized gravel or stone (typically 20-50mm diameter). A permeable filter cloth is placed over the gravel, and the bed is filled with sand and covered with a layer of topsoil in which grass is planted. To keep beds aerobic and prevent clogging they should be as shallow as possible, and not more than 1m deep.

The size of an evapotranspiration bed will depend on local evapotranspiration and rainfall rates (available from nearby weather stations), and daily wastewater flow (or loading rate). Loading rates of up to 10 litres/m²/day can be applied, although performance will depend on soil type, vegetation, wind speed, humidity, solar radiation and temperature. Any rainfall runoff should be diverted around the system.

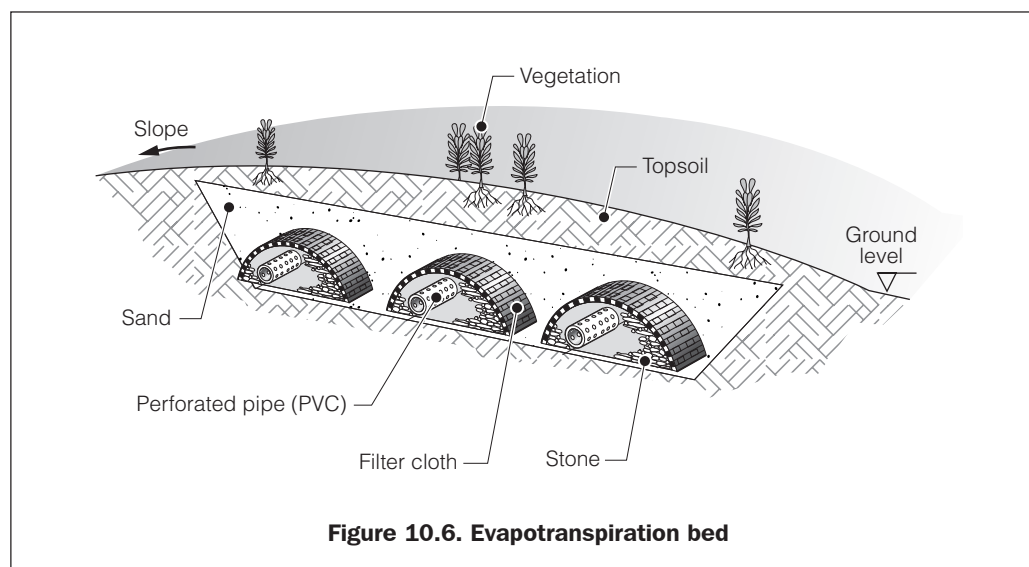

Figure 10.6. Evapotranspiration bed

WASTEWATER MANAGEMENT

Advantages: These beds are suitable in arid conditions where other disposal methods are inappropriate.

Constraints: Careful management is required; and the beds can only cope with a limited volume of wastewater.

10.4.7 Irrigation

Where large volumes of wastewater are generated it may be appropriate to make use of this for small-scale irrigation. This may simply consist of planting fast-growing fruit trees, such as papaya or banana, in the drainage channels. Alternatively, drainage channels may be used to divert the flow to small areas of arable land which may be deliberately flooded with wastewater to promote plant growth.

In general, wastewater cannot be used for large-scale irrigation and careful monitoring should occur to ensure that clean drinking water is not diverted for irrigation use, especially where there is a limited water supply.

Advantages: Irrigation can make use of large volumes of water; and contributes to agricultural activity in the affected area.

Constraints: In general, small-scale possibilities only are viable; and it may encourage inappropriate use of drinking water.

10.5 Wastewater treatment

Although many of the methods outlined above involve some treatment as well as simple disposal of wastewater, it is sometimes necessary to implement additional treatment facilities. Where wastewater has high solids, oil or detergent content it will be necessary to separate these components prior to disposal. This is likely to be especially appropriate for wastewater from kitchens or feeding centres catering for large populations.

10.5.1 Solids removal

Wastewater with a high solids content should be strained, especially if infiltration techniques are to be used. This will prevent soil pores from quickly becoming clogged and preventing infiltration. A simple method of solids removal is to pass the wastewater through a woven sacking strainer. Alternatively a crude plastic filter may be made by cutting small slots in the base of a plastic bucket. These should regularly be inspected and cleaned as required.

10.5.2 Grease traps

A grease trap, as the name suggests, is designed to trap grease or oil and allow treated wastewater out. This should be sited upstream of the final disposal system. A simple grease trap (Figure 10.7) consists of an inlet with a strainer to remove solids, and a series of baffles. These baffles are designed to trap grease, which floats to the liquid's surface, so that only clean water travels underneath and eventually out through the overflow. Grease traps should be emptied of grease at regular intervals, preferably daily. Traps can be built from bricks, blocks, wood or an oil drum cut in half along its longest axis.

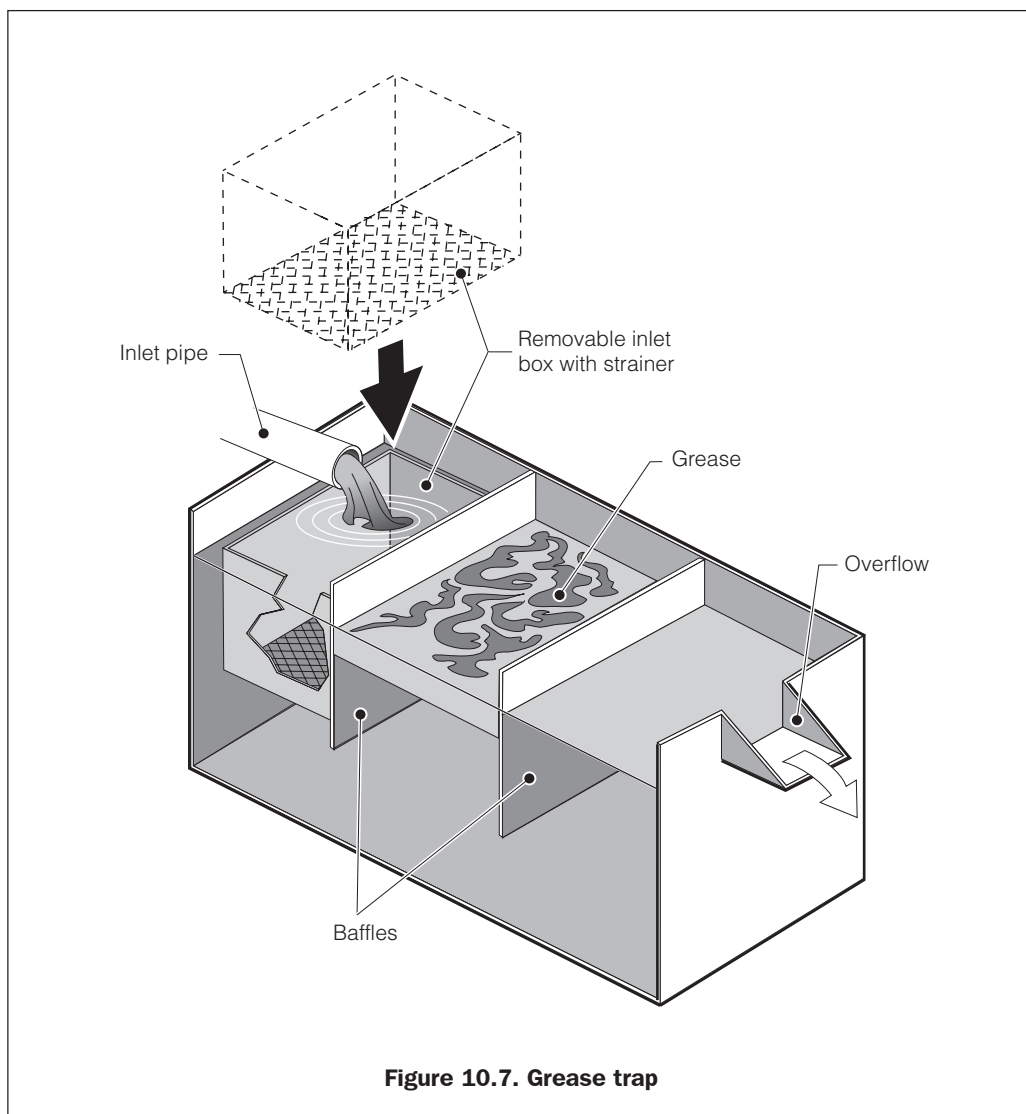

10.5.3 Settlement tanks

A more sophisticated version of the grease trap is a settlement tank (Figure 10.8). This works on the same principle to trap grease or 'scum' on the liquid surface and also allows suspended solids to settle forming a sludge deposit on the base of the tank.

The outflow from the tank should go to a soakage pit or trench, or a nearby watercourse. The settled material in the tank should be removed and buried when the tank is about one-third full of solids. Table 10.1 indicates appropriate settlement tank sizes for different flow rates (see 10.3.5 for guideline flow rates).

WASTEWATER MANAGEMENT

Table 10.1. Sizes of settlement tanks

Inflow rate (litres/day)	Liquid depth ^a (m)	Tank length ^b (m)	Tank width (m)
2000	1.2	1.9	1.0
5000	1.4	2.8	1.4
10000	1.5	3.3	1.7
15000	1.5	3.4	1.7
20000	1.5	4.0	2.0

- a Allow 30cm extra tank depth above liquid level
- b First compartment twice the length of second

These sizes assume that the solids will be removed from the tank every three months. Where the system is to become permanent, a larger tank may be constructed which needs emptying less often.

10

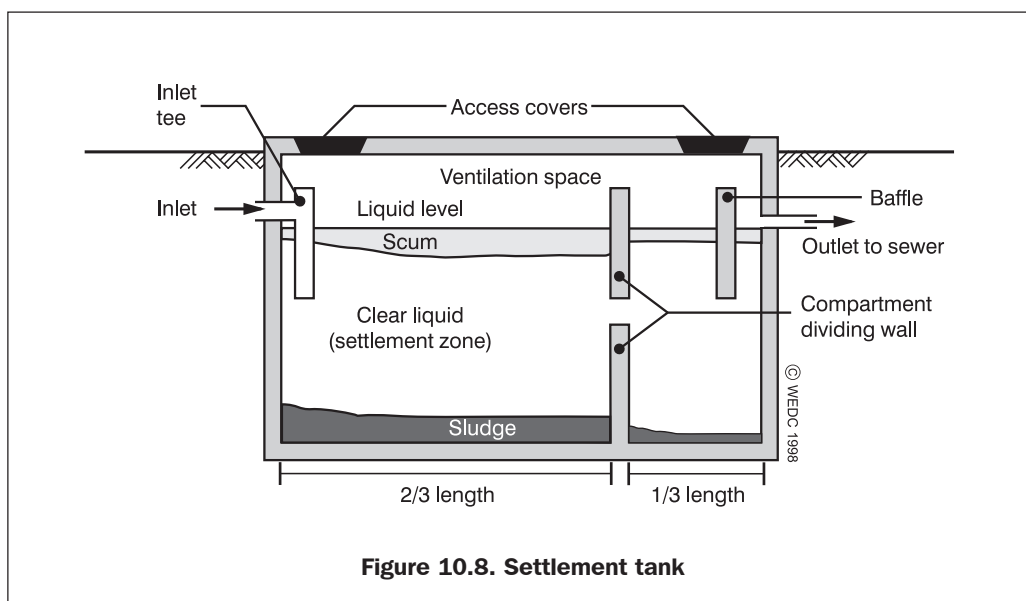
**Figure 10.8. Settlement tank**

EMERGENCY SANITATION

Settlement tanks may be constructed above or below the ground. The tank walls can be built from concrete, bricks, timber or earth. The tank should have a minimum depth of 1.2m to allow adequate settling, and at least 0.3m between the liquid surface and the base of the cover for ventilation. The inlet and outlet may be made using a 'tee' piece (Figure 10.9), or for larger units a weir may be used for the outlet.

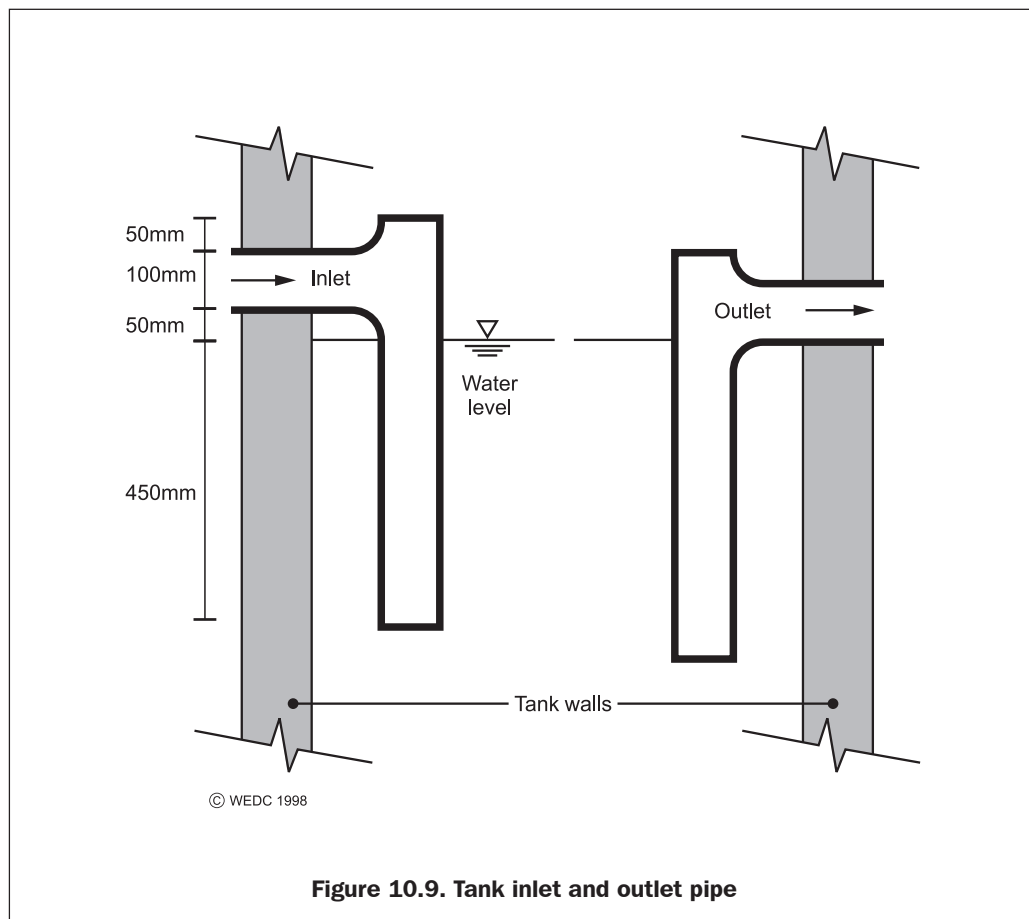

10.5.4 Septic tanks

In a large public institution such as a hospital or medical centre septic tanks can also be used for disposal of wastewater from kitchen, laundry and washing facilities. This dilutes the effluent from toilets and can be used for treating both sewage and grey wastewater (see Section 6.8.10 for design details).

10.5.5 Reed beds

Man-made reed beds (or constructed wetlands) treat wastewater by removing organic matter, oxidising ammonia, reducing nitrate and removing phosphorous (Cooper et al., 1996). Reed

WASTEWATER MANAGEMENT

beds can be used to treat sewage effluent as well as sullage and generally consist of a gravel-filled bed covered with a layer of soil or sand in which reeds are planted. Once treated the water can be discharged to a natural watercourse. There are two main types of bed, either vertical flow or horizontal flow.

Figure 10.10 shows a horizontal reed bed where wastewater is fed into the bed via an inlet stone distributor (resembling a small soak pit). Wastewater flows horizontally from the distributor at one end of the bed to an outlet at the other. A 30-50cm depth of water should be maintained in the bed. Horizontal flow beds are simple to operate and maintain but take up more land area than vertical flow beds.

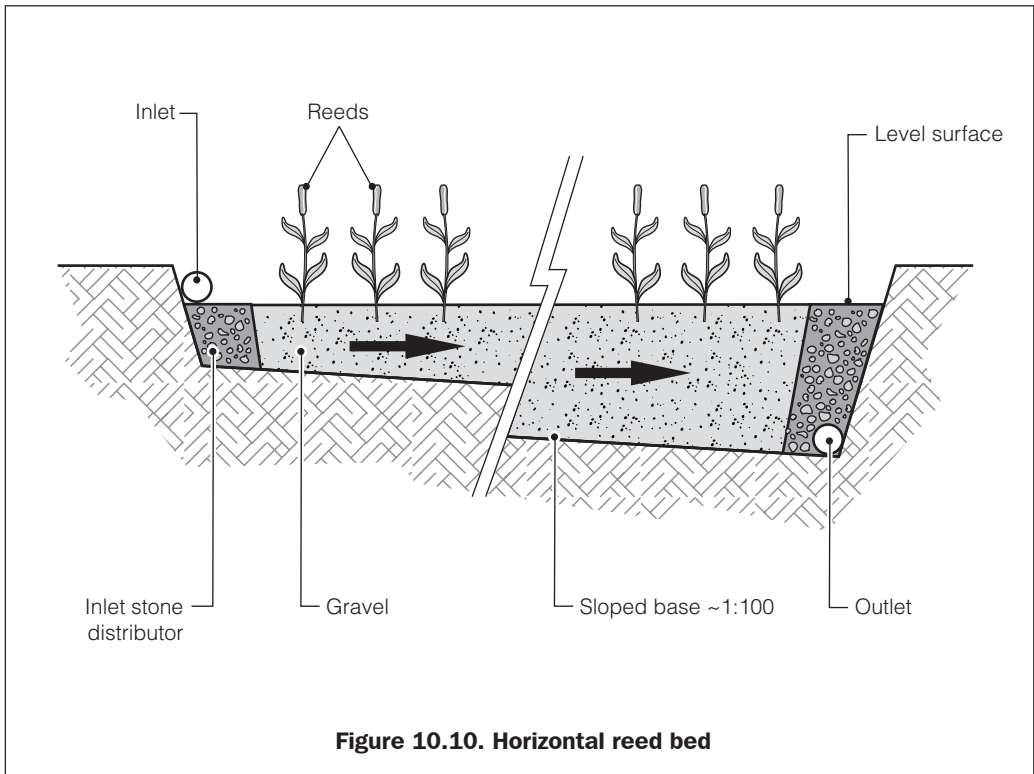

EMERGENCY SANITATION

Vertical flow reed beds allow wastewater to trickle down through the bed media as illustrated in Figure 10.11. Here the wastewater must be introduced to the system in batches so that the bed is completely flooded for a while and is then allowed to drain. This allows air to be trapped in the soil and the extra oxygen results in more effective removal of nitrogen compounds and phosphates from the wastewater (Smith, 2001). Vertical flow beds require more intensive management than horizontal beds and a secondary system for holding back each batch of wastewater is required.

Reed bed systems must be carefully sized (see Cooper et al., 1996) and inlet troughs and pipes should be cleaned at monthly intervals to prevent blockages.

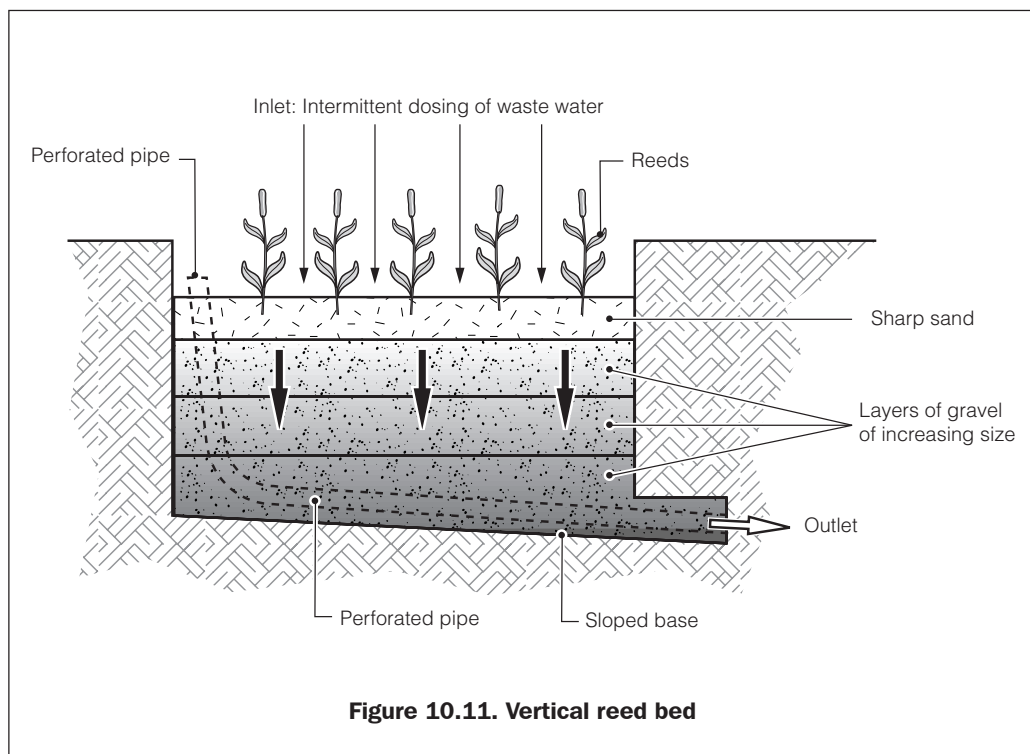

10.6 Cholera treatment centres

Wastewater from medical installations dealing with specific epidemics, such as cholera treatment centres, should have independent wastewater management systems. It is important that any infection is contained and that the spread of epidemic is minimised. Large waste volumes of chlorine-based disinfectants are also likely to be produced in such cases, since these are used to wash down facilities and equipment. In general, such installations should have their own septic tank and underground disposal (e.g. soakpit) isolated from both ground and surface water sources.

10.7 Rainfall runoff

Although this book is not dealing with site drainage specifically, it is important that this is considered, especially in areas of high rainfall. Drainage of rainfall runoff may be essential to prevent erosion of soil and soil-based buildings, to allow safe access and movement around the site, and to minimise areas of standing water. It is also important that sanitation facilities such as pit latrines, refuse pits and soakpits are designed so as not to fill with rainwater following heavy rainfall, in order to prevent the spread of disease.

In general, drainage channels should be constructed to ensure that the site does not become a swamp every time it rains. These channels may also be used to dispose of wastewater which may be diluted with rainwater. All drainage facilities must be adequately maintained, and regular inspection and cleaning should be conducted.

References and further reading

- Adams, John (1999) *Managing Water Supply and Sanitation in Emergencies*. Oxfam: Oxford.
- Ayoade, J.O. (1988) *Tropical Hydrology and Water Resources*. Macmillan Publishers: Basingstoke & London.
- Cairncross, S. and Feachem, R. (1983) *Environmental Health Engineering in the Tropics: An introductory text*. John Wiley & Sons: Chichester.
- Cooper, P.F., Job, G.D., Green, M.B. and Shutes, R.B.E. (1996) *Reed Beds and Constructed Wetlands for Wastewater Treatment*. WRC: Swindon.
- Davis, Jan and Lambert, Robert (1996) *Engineering in Emergencies: A practical guide for relief workers*. RedR / IT Publications: London.
- Médecins Sans Frontières (1994) *Public Health Engineering in Emergency Situation*. Médecins Sans Frontières: Paris.
- Reed, R. and Dean, P.T. (1994) Recommended Methods for the Disposal of Sanitary Wastes from Temporary Field Medical Facilities. *Disasters* Vol 18, No 4.
- Smith, Mike (2001) *Wastewater Treatment: A postgraduate distance learning module*. WEDC, Loughborough University: UK.

Chapter 11

Hygiene promotion

Note: It is accepted by the authors that the term ‘Hygiene Promotion’ can be used in a number of ways. For the purposes of this publication hygiene promotion concerns reducing high-risk hygiene practices, promoting appropriate use and maintenance of sanitation facilities, and promoting participation in sanitation programmes. A list of references to specialist books on hygiene promotion is provided at the end of the chapter.

11

A number of studies have suggested that the impact of hygiene practices on sanitation-related disease could be as great as that of the actual provision of sanitation facilities. Hygiene promotion is widely believed to be one of the most effective means we have to reduce the toll of diarrhoeal diseases. It can also be an effective way to encourage participation and empower communities. Despite this apparent awareness, hygiene promotion is still often given far less emphasis than traditional water supply and sanitation activities.

11.1 Hygiene and health

Hygiene behaviour has a critical influence on the transmission of disease at various stages. This is particularly important in emergency situations where disease risks are acute due to overcrowding, poor water and sanitation, exposure to new pathogens, low resistance to disease, and disturbance of familiar and safe habits. The most obvious effects can be observed for faecal–oral or diarrhoeal diseases. Hygiene practices may also influence the transmission of soil-based diseases (e.g. hookworm), skin diseases and disease transmitted by insect-vectors (e.g. malaria).

A primary barrier to the transmission of faecal–oral disease is safe defecation, to prevent faecal pathogens entering the human environment. A secondary barrier is handwashing, to ensure that faecal contamination on hands is not transmitted via food or water. Table 11.1 shows the recorded effects of handwashing and safe excreta disposal on diarrhoeal disease.

EMERGENCY SANITATION

Table 11.1. The effects of hygiene practice on diarrhoeal disease^a

<i>Hygiene practice</i>	<i>Impact</i>
Handwashing with soap and water after contact with faecal material	35 per cent or more reduction in diarrhoeal diseases
Using a clean pit latrine and disposing of children's faeces in it	36 per cent or more reduction in diarrhoea incidence

^aSource: Almedom et al. 1997

The main hygiene areas of concern for emergency hygiene promotion programmes are:

- the appropriate use and maintenance of sanitation facilities;
- the safe disposal of faeces;
- handwashing after defecation and prior to food preparation;
- clean water use and storage; and
- the control of flies and other insect vectors.

The overall sanitation programme objective of reducing the prevalence of sanitation-related diseases must be considered in planning an appropriate hygiene promotion response. Consultation with qualified health professionals working in the region may help to identify priorities by linking hygiene practices with disease prevalence.

11.2 Definition of hygiene promotion

Hygiene promotion can be defined as 'the mix between the population's knowledge, practice and resources, and agency knowledge and resources which together enable risky hygiene behaviours to be avoided' (Sphere Project, 1999).

Effective hygiene promotion relies on an exchange of information between the agency and the affected community in order to identify key hygiene problems and to design, implement and monitor a programme to promote hygiene practices that will deal with these problems. This definition recognises that hygiene behaviour and the material means for healthy living should be promoted together.

11.3 Focus of hygiene promotion in emergencies

In general, the focus of hygiene promotion in emergencies can be divided into three distinct elements:

- Reducing high-risk hygiene practices
- Promoting appropriate use and maintenance of facilities
- Promoting participation in programmes

HYGIENE PROMOTION

Hygiene promotion may be used to help the affected population to avoid and limit the extraordinary hygiene risk created by the emergency situation as a result of overcrowding and poor sanitation; and to help people to understand the importance and operation of new facilities provided. In addition, through hygiene promotion community mobilisation can be included to encourage the participation of the affected population in watsan programme activities.

11.3.1 Setting objectives and indicators

The objectives of hygiene promotion activities should be considered very carefully in order to avoid distorting key messages, confusing the affected population or sending messages to the wrong people. The understanding gained through assessing hygiene risk should be used to plan and prioritise assistance, so that information flows usefully between the agency and the affected population. Indicators should also be selected (see 11.9) to help focus activities and monitor progress.

11.3.2 When should we consider hygiene promotion activities?

Hygiene promotion should be considered in **all** emergency sanitation programmes. Despite the fact that emergency situations vary greatly, it remains important to include hygiene promotion in all the stages of the project cycle as far as possible.

Although in the very early stages of an emergency resources and organisational capacities may be severely limited, the earlier hygiene promotion activities commence the sooner their impact will be felt and the sooner long-term benefits will reach the population.

11.3.3 Links with other activities

Hygiene promotion can be a stand-alone activity or it can figure as a planned part of water, sanitation and diarrhoeal disease programmes. The principal danger of incorporating it into a wider programme is that it usually becomes the poor relation, with a low priority for resource allocation and management time. This is almost inevitable when the main priority is seen as the number of wells or latrines constructed. It may be advisable to create separate but linked programmes, each with their own targets and management arrangements (Curtis, 1999).

11.4 Key principles of hygiene promotion

To determine the direction and objectives of any hygiene programme it is important to dispel inaccurate assumptions and adhere to several key principles.

11.4.1 Myths of hygiene promotion

The following are several common myths concerning hygiene and health education programmes:

- People are empty containers into which new ideas can simply be poured.
- Hygiene promotion can target many risk practices at the same time.
- Hygiene promotion can reach the entire population easily.
- New ideas replace old ideas.
- Knowing means doing.

Perhaps the most commonplace mistakes are assuming that the whole population can be targeted and that if people know something they will automatically change their behaviour.

11.4.2 Key principles of hygiene promotion

It is recommended that the practitioners keep to the following seven principles of hygiene promotion (from Curtis, 1999):

1. Target a small number of risk practices.

From the viewpoint of controlling diarrhoeal disease, the priorities for hygiene behaviour change are likely to include handwashing with soap (or a local substitute) after contact with faeces, and the safe disposal of adults' and children's faeces.

2. Target specific audiences.

These may include mothers, children, older siblings, fathers, opinion leaders, or other groups. One needs to identify who is involved in childcare, and who influences them or takes decisions for them.

3. Identify the motives for changed behaviour.

These motives often have nothing to do with health. People may be persuaded to wash their hands so that their neighbours will respect them, so that their hands smell nice, or for other motives. By working with the target groups one can discover their views of the benefits of the safer hygiene practices. This provides the basis for a motivational strategy.

4. Hygiene messages need to be positive.

People learn best when they laugh, and will listen for a long time if they are entertained. Programmes which attempt to frighten their audience will alienate them. There should therefore be no mention of doctors, death or diarrhoea in hygiene promotion programmes.

5. Identify appropriate channels of communication.

We need to understand how the target audiences communicate. For example, what proportion of each listens to the radio, attends social or religious functions, or goes to the cinema? Traditional and existing channels are easier to use than setting up new ones, but they can only be used effectively if their nature and capacity to reach people are understood.

6. Decide on a cost-effective mix of channels.

Several channels giving the same messages can reinforce one another. There is always a trade-off between reach, effectiveness and cost. Mass media reach many people cheaply, but their messages are soon forgotten. Face-to-face communication can be highly effective in encouraging behaviour change, but tends to be very expensive per capita.

7. Hygiene promotion needs to be carefully planned, executed, monitored and evaluated.

At a minimum, information is required at regular intervals on the outputs (e.g. how many broadcasts, house visits, etc.), and the population coverage achieved (e.g. what proportion of target audiences heard a broadcast?). Finally, indicators of the impact on the target behaviours must be collected and fed into the planning process.

HYGIENE PROMOTION

11.5 Staff

Carefully selected and trained staff provides a key component of any hygiene promotion programme. The initial inputs required for recruitment and training are likely to be significant but these will decrease with time.

11.5.1 Recruitment of facilitators

Hygiene promotion facilitators or outreach workers should preferably meet the following criteria; they should be

- from among the target population;
- able to communicate in the mother tongue of those targeted;
- respected figures within the community;
- reasonably well educated and able to learn quickly; and
- motivated to improve living conditions for all.

Potential facilitators may be male or female and include:

- elders;
- traditional birth attendants;
- community leaders;
- health workers; and
- teachers.

The selection of appropriate staff is likely to be the single most important factor in influencing the effectiveness of an appropriate programme. Ideally, by the long-term stage of a programme there should be at least one facilitator to every 500 people or every 100 families. In general, salaries should not be offered in the first instance, although this will depend on the policy of the agency concerned.

11.5.2 Training

The training of facilitators should focus on the following topics:

- communication skills;
- health problems related to sanitation in emergency situations and suggested prevention strategies;
- traditional beliefs and practices;
- promotional methods for the use of sanitary facilities among adults and children;
- basic health messages and their limitations;
- use of songs, drama, puppet shows, etc.;
- gender issues (see 11.6);
- targeting various groups and especially vulnerable groups within the affected area; and
- monitoring and evaluation activities.

Creative training methods are most likely to inspire creative promotional methods.

11.6 Women, men and children

The fact that hygiene promotion activities should target all sections of the community is often mentioned in the available literature, but rarely happens in practice. Women, men and children often prioritise their health needs differently, and should be given the chance to express their feelings and to influence programme planning and decision-making.

11.6.1 Women

Women are often the primary targets for hygiene promotion messages and with good reason. Generally, women and girls undertake the majority of domestic duties within the family and are responsible for monitoring the behaviour of young children. If women receive, understand and act on messages concerning hygiene behaviour then this is likely to influence other family members. Emphasising women's roles in this way reinforces gender stereotyping, however, and may add to the burden of responsibility felt by women in difficult circumstances.

11.6.2 Men

In general, men are the least-targeted gender group in hygiene promotion campaigns. There may be several reasons for this, such as:

- Men are not considered appropriate targets among programme staff.
- Men themselves do not consider hygiene promotion relevant to them.
- The majority of hygiene promoters are women and are uncomfortable talking to men.
- Men are too 'busy' with other activities.

Excluding men completely from promotional activities may inadvertently increase hygiene-related risks in another area of the site. For example, construction sites where men are working may have no latrines or handwashing facilities, and this may have been missed by the hygiene team. Men can have an important influence on the effectiveness of sanitation and hygiene promotion activities, due to their power as family heads, and must therefore be involved in planning and implementing hygiene promotion programmes.

11.6.3 Children

Some practitioners have implemented successful hygiene promotion programmes whereby children are the key facilitators in passing hygiene messages to other children and family members. This is particularly effective where there are existing schools so that hygiene programmes can be incorporated into the overall curriculum. Such 'child-to-child' activities should be:

- important for the health of children and their community;
- easy enough for children to understand;
- simple for children to do well; and
- interesting and fun! (Hanbury, 1993)

Field experience has shown that children are capable of caring for other children their own age or younger than them, influencing family members and spreading hygiene messages in their own communities.

HYGIENE PROMOTION

11.6.4 Disabled people

Disabled people and their carers are likely to have specific needs and priorities which may not be applicable to the rest of the population. It is important that programmes recognise this and give mentally and physically disabled people the chance to voice their opinions. Hygiene promoters may also act as messengers to relay important information regarding vulnerable people to health and managerial staff.

11.7 Hygiene promotion actions

Hygiene promotion methods can be conducted:

- on a one-to-one basis;
- in groups; or
- on mass.

Mass media is often necessary in an emergency in trying to reach a large population; however, this can be conducted at the same time as more intensive approaches that focus on small groups of the most vulnerable people.

11.7.1 Identifying problems and solutions

Participatory approaches such as Participatory Rural Appraisal (PRA) and Problem-tree analysis (Chapter 12) can be used to provide an opportunity for community members to analyse their own situations and make their own choices about their hygiene practices. Building on what people already know rather than importing ideas from ‘outsiders’ should be the basis for any hygiene promotion programme.

Discovering local names for diseases can be useful since local people may attribute certain diseases to specific causes which may not relate at all to current medical theory. For example, there may be several names for diarrhoea which may all have their own distinct causes and treatments (Morgan and Nahar, 2001). This information can be essential in designing an effective hygiene promotion campaign based on what people actually know and do at present.

11.7.2 Promoting participation

An important component of most hygiene promotion programmes in emergencies is the promotion of community participation in sanitation-related activities. This may include involvement in design, construction, operation and maintenance of sanitation facilities and systems for each of the sanitation sectors included in this Manual. Information regarding appropriate methods for community participation in these areas is included in Chapter 12.

11.7.3 Influencing hygiene behaviour

The most problematic element of hygiene promotion is not identifying the things that people need to do, but determining **how** they can be influenced to do them. Once a small number of risk practices have been identified, it is important to determine what is likely to motivate behaviour change. Information about improvements in health and disease hazards may have little effect in promoting change.

EMERGENCY SANITATION

11.7.4 Focus group discussions

Focus group discussions can be very useful in determining what factors are likely to influence behaviour change and what the key priorities and perceptions are among particular groups. An example structure for a focus group discussion has been reproduced in Table 11.2.

Table 11.2. Focus group discussion agenda (adapted from UNICEF, 1998)

Objective:	To establish what might motivate handwashing with soap and safe disposal of faeces.
Introduction:	Introduce participants; explain focus of meeting and that people are free to say what they wish.
Perceptions about hygiene:	What sort of things are clean? What are the advantages of cleanliness?
Handwashing:	When is handwashing a good idea? Why? When do you need to use soap? Why?
Perceived advantages of safe disposal of faeces:	Are faeces clean or dirty? What's wrong with them? How can they be avoided? What are the advantages of disposing of faeces in a latrine?
Adopting target practices:	Could you adopt these practices? Why? What would make it easier?
Closure:	Summarise discussion, answer any questions, promise feedback.

11.7.5 Communication channels

There are many ways in which messages concerning hygiene can be communicated to members of the affected community. Visible signs can be located in public places such as:

- market areas;
- schools;
- feeding centres;
- distribution centres;
- medical centres;
- worship places;
- water collection points; and
- close to sanitation facilities.

HYGIENE PROMOTION

Other channels include:

- house visits and interviews;
- school lessons;
- posters and models;
- public and group meetings;
- announcing through loud speakers;
- radio programmes;
- TV programmes; and
- drama and music.

Programme staff should try to be open to innovative promotional ideas from within the team and among the population at large.



Model of off-set latrine used for hygiene promotion purposes in China

11.8 Intervention levels

One key aspect of hygiene promotion is to target a small number of risk practices only. For this reason it is important that activities are **planned in stages**, rather than trying to tackle all hygiene promotion needs at once.

Table 11.3 indicates various intervention activities which can be undertaken at different stages of an emergency

Table 11.3. Recommended interventions for different scenarios				
Scenarios and recommended interventions	<i>The affected population go through a transit camp immediately after a disaster</i>	<i>The affected population remain in a temporary location for up to six months</i>	<i>The affected population stay in the affected area immediately after a disaster</i>	<i>The affected population move to a new area and are likely to remain for more than a year</i>
Immediate action	<ul style="list-style-type: none"> ■ Recruitment and training of hygiene promoters/facilitators ■ Recruitment and training of communal latrine attendants ■ Identifying knowledge and resources within the affected community ■ Basic messages for correct use of new facilities: latrines; waste pits; waterpoints, etc. ■ Assessment and monitoring of sanitation facilities to lead to positive action for change 			
Short-term measure	<ul style="list-style-type: none"> ■ Hygiene promotion focus: faeces disposal; handwashing; refuse disposal ■ Assessment and monitoring of 			
Long-term measure			<ul style="list-style-type: none"> ■ Community mobilisation and involvement in design, implementation, operation and maintenance of sanitation facilities ■ Hygiene programme targeting: vulnerable groups; women; children; men ■ Hygiene promotion focus: faeces disposal; handwashing; refuse disposal ■ Assessment and monitoring of sanitation activities 	

11.9 Key indicators for hygiene practice

One of the key aims cited in the *Sphere Project* is to ensure that all sections of the affected population are aware of priority hygiene practices that create the greatest risk to health and are able to change them. It goes on to say that all people should have adequate information and resources for the use of water and sanitation facilities to protect their health and dignity. The following sections list key indicators for hygiene practice linked to each sanitation sector (adapted from Sphere Project, 1999).

11.9.1 Excreta disposal

- People use the toilets available and childrens faeces are disposed of immediately and hygienically.
- People use toilets in the most hygienic way, both for their own health and for the health of others.
- Household toilets are cleaned and maintained in such a way that they are used by all intended users and are hygienic and safe to use.
- Parents (mothers and fathers) demonstrate awareness of the need to dispose of children's faeces safely.
- Families and individuals participate in a family latrine programme by registering with the agency, digging pits or collecting materials.
- People wash their hands after defecation and handling children's faeces and before cooking and eating.

11.9.2 Solid waste management

- Waste is put in containers daily for collection, or buried in a specified refuse pit.

11.9.3 Waste management at medical centres

- Parents and children are aware of the danger of playing with needles and dressings from medical facilities, in cases where the minimum standard for the disposal of medical waste is not met.

11.9.4 Disposal of the dead

- People have the resources and information necessary to carry out funerals in a manner which respects their culture and does not create a risk to health.

11.9.5 Wastewater management

- Areas around shelters and waterpoints are free of standing wastewater, and local wastewater drains are kept clear.
- People remove standing water from around their dwellings and living areas, and dispose of wastewater in an appropriate manner.
- There is a demand for tools for drainage works.
- People avoid entering water bodies where there is a schistosomiasis risk.

11.10 Key indicators for programme implementation

Ideally, all sanitation facilities and resources provided should reflect the vulnerabilities, needs and preferences of all sections of the affected population. The key indicators for the effective implementation of a hygiene programme are given below (Sphere Project, 1999).

11.10.1 Key indicators

- Key hygiene risks of public health importance are identified in assessments and in the objectives for hygiene promotion activities.
- The design and implementation process for water supply and sanitation programmes includes and operates a mechanism for representative input from all users.
- All groups within the population have access to the resources or facilities needed to achieve the hygiene practices that are promoted.
- Hygiene promotion activities address key behaviours of importance for public health and they target priority groups.
- Hygiene and behaviour messages, where used, are understood and accepted by the intended audience.
- Users take responsibility for the management and maintenance of water supply and sanitation facilities as appropriate.

11.11 Relationship with other aspects of sanitation

Hygiene promotion is strongly related to all other sanitation sectors and environmental health. It is potentially the foundation on which the rest of an emergency sanitation programme is built, especially in the latter stages of an emergency, and should provide a dynamic link between medical and technical staff. Hygiene promotion is often the most effective means of introducing a family latrine programme or household solid waste management. It is also essential in establishing the priorities and needs of the affected community, and feeding these into the overall sanitation programme. For this reason it is important that hygiene promoters work in close collaboration with engineers, technicians and medical staff.

Further reading

- Adams, John (1999) *Managing Water Supply and Sanitation in Emergencies*. Oxfam: Oxford.
- Almedom, Astier M.; Blumenthal, Ursula & Manderson, Lenore (1997) *Hygiene Evaluation Procedures; Approaches and methods for assessing water and sanitation related practices*. London School of Hygiene and Tropical Medicine (LSHTM) and International Nutrition Foundation for Developing Countries (INFDC): London.
- Boot, Marieke T. and Cairncross, Sandy. (1993) *Actions Speak: The study of hygiene behaviour in water and sanitation projects*. IRC: Hague.
- Curtis, Valerie (1999) *Hygiene Promotion*. WELL Technical Brief. <http://www.lboro.ac.uk/well/services/tecbriefs/hygiene.htm>
- Ferron, Suzanne; Morgan, Joy and O'Reilly, Marion (2000) *Hygiene Promotion: From relief to development*. CARE/Intermediate Technology: UK.
- Hanbury, Clare (1993) *Child-to-Child and Children Living in Camps*. The Child-to-Child Trust: London.

HYGIENE PROMOTION

Morgan, Joy and Nahar, Qumrun (2001) (UNICEF, Bagladesh) Personal Communication (e-mail 2 Oct. 2001)

Sphere Project (1999) *Humanitarian Charter and Minimum Standards in Disaster Response*. Standing Committee for Humanitarian Response (SCHR): Geneva.

<http://www.sphereproject.org>

UNICEF (1998) *Happy, Healthy and Hygienic: How to set up a hygiene promotion programme*. United Nations Children's Fund: New York.

WHO (1998) *PHAST Step-by-step Guide: A participatory approach for the control of diarrhoeal disease*. World Health Organisation: Geneva.

Chapter 12

Community participation

‘The myth that the affected population is too shocked and helpless to take responsibility for their own survival is superseded by the reality that on the contrary, many find new strength during an emergency’ (Goyet, 1999).

It is the strong conviction of the authors that communities affected by disasters should be given the maximum opportunity to participate in emergency relief programmes. Participation, here, does not simply mean being involved in the construction of facilities, it means contributing ideas, making decisions and taking responsibility. All too often refugees and displaced people are treated by relief agencies as helpless entities that need to be fed, watered and sheltered. The fact that they are people with considerable knowledge, skills, empathy and pride is often overlooked or forgotten.

12

12.1 What is meant by community participation?

Community participation can be loosely defined as the involvement of people in a community in projects to solve their own problems. People cannot be forced to ‘participate’ in projects which affect their lives but should be given the opportunity where possible. This is held to be a basic human right and a fundamental principle of democracy. Community participation is especially important in emergency sanitation programmes where people may be unaccustomed to their surroundings and new sanitation facilities.

Community participation can take place during any of the following activities:

- **Needs assessment** – expressing opinions about desirable improvements, prioritising goals and negotiating with agencies
- **Planning** – formulating objectives, setting goals, criticising plans
- **Mobilising** – raising awareness in a community about needs, establishing or supporting organisational structures within the community
- **Training** – participation in formal or informal training activities to enhance communication, construction, maintenance and financial management skills
- **Implementing** – engaging in management activities; contributing directly to construction, operation and maintenance with labour and materials; contributing cash towards costs, paying of services or membership fees of community organisations

EMERGENCY SANITATION

- **Monitoring and evaluation** – participating in the appraisal of work done, recognising improvements that can be made and redefining needs

Most emergency sanitation programmes tend to be designed and executed by the relief agency; however, this does not mean that the community is unable or unwilling to participate in some or all of the activities outlined above.

12.1.1 Incentives of community participation

The following are some of the main reasons why people are usually willing to participate in humanitarian programmes:

- Community participation motivates people to work together – people feel a sense of community and recognise the benefits of their involvement.
- Social, religious or traditional obligations for mutual help
- Genuine community participation – people see a genuine opportunity to better their own lives and for the community as a whole
- Remuneration in cash or kind

There are often strong genuine reasons why people wish to participate in programmes. All too often aid workers assume that people will only do anything for remuneration and have no genuine concern for their own predicament or that of the community as a whole. This is often the result of the actions of the agency itself, in throwing money or food at community members without meaningful dialogue or consultation. Remuneration is an acceptable incentive but is usually not the only, or even the primary, motivation.

12.1.2 Disincentives to community participation

The following are some of the main reasons why individuals and/or community may be reluctant to take part in community participation:

- An unfair distribution of work or benefits amongst members of the community
- A highly individualistic society where there is little or no sense of community
- The feeling that the government or agency should provide the facilities
- Agency treatment of community members – if people are treated as being helpless they are more likely to act as if they are

Generally, people are ready and willing to participate; the biggest disincentive to this is probably the attitude and actions of the agency concerned. Treating people with respect, listening to them and learning from them will go a long way toward building a successful programme; it will also save time and resources in the long run and contribute greatly to programme sustainability. Fieldworkers who expect members of the affected community to be grateful for their presence without recognising and empathising with them as people may satisfy their own egos but will have little other positive effect.

COMMUNITY PARTICIPATION

Community participation can contribute greatly to the effectiveness and efficiency of a programme; the crucial factor in its success is the attitude of agency staff in the field. If staff do not treat people with respect or are seen to favour particular individuals or groups within a community, this can have a highly destructive effect on participation. For this reason it is important to identify key representatives and groups within the affected population early.

12.2 Stakeholder analysis

It may not be possible for each and every member of the affected population to contribute to a programme equally but attempts can be made to identify key groups and individuals that can be actively involved. A useful tool to assess whom the programme will affect (positively or negatively) and therefore who should have a stake in the programme is stakeholder analysis. This should be used to identify key stakeholders and their interests. Stakeholders may include different people from within the affected population, as well as local authorities and agencies.

Table 12.1 shows an example of a stakeholder analysis for a refugee camp. Stakeholders are divided into primary (from within the affected community), secondary (local authorities, agencies, etc.) and external (other interested parties).

The likely effect or impact of the programme on each stakeholder is indicated as either positive or negative. The influence of these stakeholders over the current project is ranked between 1 and 6; 1 for maximum influence and 6 for minimum influence. The importance of each stakeholder for programme success is also ranked between 1 and 6, 1 being most important. This ranking can be done by a group of agency staff at the onset of an emergency programme, or by a group of different stakeholders, however the process should be as objective as possible.

This is only an example and numbers may vary considerably depending on the situation. The purpose of this tool is to identify all those on whom the programme will have an effect and assess the relative importance and influence of those groups or individuals. If, as in the above example, community members are of great importance but have little influence over the programme, community participation techniques can be used to overcome this and give these stakeholders greater say.

EMERGENCY SANITATION

Table 12.1. Example stakeholder analysis

<i>Stakeholders</i>	<i>Interests at stake in relation to programme</i>	<i>Effect of programme on interests</i>	<i>Importance of stakeholder for programme success</i>	<i>Influence of stakeholder over programme</i>
Primary stakeholders				
Women	Improved access to sanitation facilities Better health	(+)	1	5
Children	Improved access to sanitation facilities Better health and safety	(+)	1	6
Disabled people	Improved access to sanitation facilities Better health	(+)	1	6
Men	Job opportunities Better health	(+)	1	4
Secondary stakeholders				
Civil/religious leader	Safeguard their influence within the affected population Mobilise the affected community	(+)/(-)	4	4
Elders	Respect and influence	(+)/(-)	3	3
Local authority	Maintain political power/control	(+)/(-)	2	6
NGOs in the affected area	Health and well-being of community	(+)/(-)	4	4
Local supplier	Sales and profits	(+)	2	6
Agency project team	Co-ordination of activities	(+)	2	2
External stakeholders				
Donor	Short-term disbursement of funds Effective and efficient delivery of programme	(-) (+)	2	2
Local population	Increased trade potential Disparity in service provision	(+) (-)	6	6

12.3 Gender and vulnerable groups

It is very important to make sure that minority groups, low status groups and poorer groups in a community are not left out and that women, men and children are specified in consultation processes.

12.3.1 Gender

Gender is based on sex but is more to do with socially constructed distinctions (work, dress, behaviour, expectations, etc.) than purely biological differences. Gender-related differences can be split into three categories:

- Differing needs and priorities
- Power and vulnerability differences
- Equity or equality issues (Smout et al., 2000)

Consideration of gender relates to men, women, boys and girls and their needs, priorities, vulnerabilities and strengths. Ultimately, consideration of gender issues benefits everyone. Since many donors focus on the vulnerabilities of the intended beneficiaries there often tends to be a focus on women in programme activities. This is because in most scenarios women have less influence than men, and it is for this reason that women's groups are often set up to provide a forum for women's views to contribute to programme design and implementation.

It is important to recognise, however, that gender does not automatically mean a bias towards women; the emphasis should be on the pursuit of equity of opportunity.

12.3.2 People with disabilities

People with physical and mental disabilities can often be overlooked in many emergency situations. They are among the most vulnerable in most societies and are often unable to present their own needs and priorities clearly. For this reason they should be given special attention where possible. This may include the construction of special sanitation facilities, assistance in community activities and the formation of focus groups for people with disabilities.

12.3.3 Elderly people

Elderly people may have specific needs which should be considered. For example, elderly people living without younger family members may be unable to participate in physical activities such as pit excavation or latrine construction. Such vulnerable households should be identified and solutions to their problems implemented.

12.4 Participation matrix

A participation matrix is a tool to identify how different stakeholders may be involved at different stages of a programme. The columns indicate who should be informed of activities and outputs; who should be consulted in conducting these activities; who should work in partnership to achieve the intended outputs; and who has ultimate control for each stage of the programme.

Table 12.2 gives an example for an emergency sanitation programme according to the Guidelines process.

EMERGENCY SANITATION

Table 12.2. Example participation matrix

<i>Type of participation Stage in programme</i>	<i>Inform</i>	<i>Consult</i>	<i>Partnership</i>	<i>Control</i>
Rapid assessment and priority setting		Agencystaff Authorities Community	Donor agency NGOs/UNHCR; Authorities	
Programme design		Community: leaders, focus groups, women's groups etc.	Agency; NGOs/UNHCR; Authorities; Community	Implementing agency
Implementation	Agency headquarters Donor	Agency staff Community	Agency NGOs/UNHCR Authorities Community	Implementing agency
Monitoring and evaluation	Agency headquarters Donor	Authorities UNHCR Community	Agency NGOs/UNHCR Authorities Community	Implementing agency Consultants

12.5 Community mobilisation

Community mobilisation applies to the way in which people can be encouraged and motivated to participate in programme activities. In order to mobilise a community successfully it is important to identify where people's priorities lie and what it is that motivates them. A useful starting point is to identify community leaders in order to establish key contacts between the agency and the community. Care must be taken in doing this to ensure that all community members are represented.

12.5.1 Motivation

Sanitation provision is not always a prioritised demand among disaster-affected communities. Other issues such as food, water and health care may present more obvious needs. This is often due to a lack of understanding of the links between sanitation and health. The importance of hygiene promotion in helping to raise levels of awareness and sensitivity can be a key aspect of engaging and mobilising communities.

It is important to remember that no community is completely homogeneous but is likely to be made up of people with a wide range of backgrounds and characteristics. Therefore what motivates one group of people within a community may not motivate others. Raising awareness about the public health aspects of sanitation may motivate some people to participate, whilst the opportunity to raise one's status or position in society may be a much stronger motivating force for other community members.

COMMUNITY PARTICIPATION

Motivation sources may not always be immediately obvious. Male Congolese refugees in Zambia became much keener to construct family latrines once they were made aware that their female family members might be in danger of being sexually assaulted or raped when practicing open defecation (Phiri, 2001).

12.5.2 Facilitation

Many participation activities in programme design are likely to take place in a group setting. Facilitation in the context of a group meeting applies to how a person with no decision-making authority helps the group to be more efficient and effective in planning, implementing, monitoring and evaluating (Svendsen et al., 1998). This is a difficult role to assume but is important if the community is to be given real decision-making power and responsibility. Professionals may need appropriate gender training or capacity building in participatory research and planning techniques in order to become effective facilitators.

12.5.3 Capacity building

Capacity building at community level may be important to develop skills and build confidence. This may be especially important for women who may lack experience of contributing to community planning. Capacity building through skills training and confidence building can be a key ingredient in motivating and mobilising different sections of a community.

12.6 Participatory appraisal techniques

Participatory Rural Appraisal (PRA) and Rapid Rural Appraisal (RRA) are social research techniques used in the field when resources and time are often limited. These techniques require trained facilitators and substantial time investments if they are to be fully effective. The key differences between the two methods are that:

- RRA is a method used by outsiders to acquire information about a community quickly; and
- PRA is aimed at strengthening the analysing and decision-making power of the affected community.

RRA can be used by the implementing agency in assessment activities whilst PRA can be used in programme design, implementation, monitoring and evaluation. The agency can facilitate the process but it is community members that learn to analyse their situation, design and implement programme activities. From this interaction process it is hoped that agency staff from outside the community may change their attitudes and behaviour. Four PRA activities are described briefly in the following sub-sections; these are usually carried out in small focus groups.

12.6.1 Mapping

Community mapping is a useful tool for collecting information from the community concerning the location of activities which may not be obvious from observation alone. This may also help to explain how the affected community views their situation and where they see opportunities or constraints. This method is most effective when used by a small group, working to produce a large sketch map of the area in which they live. The map produced may be crudely drawn and not to scale, but can still provide valuable information.

EMERGENCY SANITATION

12.6.2 Ranking

Community members are asked to list their priorities in terms of their overall sanitation-related needs and their perceived needs for different sanitation facilities. The group facilitator should help to guide the group in considering what facilities or activities may be appropriate but ideas should come primarily from the participants. Table 12.3 shows an example ranking exercise for sanitation-related needs and priorities. The first priority is ranked 1, the second 2, and so on.

Table 12.3. Example ranking exercise

<i>Priority needs</i>	<i>Rank</i>	<i>Associated facilities/activities</i>	<i>Rank</i>
Preventing diarrhoea	4	Communal latrines Family latrines Handwashing	1 3 2
Clean environment	2	Solid waste pits Cleaning materials	2 1
Preventing malaria	3	Wastewater disposal Bed nets	2 1
Traditional funerals	1	Morgue Burial ground Coffins Concrete gravemarkers	4 1 2 3
Family facilities	5	Family latrines Family solid waste pits Cleaning materials Tools	4 3 1 2

This is a simple and rapid method for establishing what community members consider to be their primary needs. Priorities may differ greatly and this exercise may produce surprising results; in the example provided, people are much more concerned about funeral rites than they are about diarrhoea.

12.6.3 Diagramming

Diagrams, charts and cards may be used to illustrate relationships concerning people, resources or time. Examples include calendars of activities, charts of resource use or traditional leadership trees. For longer-term settlements, charts may be very useful for recording seasonal trends relating to hygiene behaviour and health, this may help in identifying and prioritising needs and actions. Shading or pictures may be used to indicate relevant months. An example is provided in Table 12.4.

COMMUNITY PARTICIPATION

Table 12.4. Example seasonal chart for health and hygiene

	Jan	Feb	Mar	Apr	May	Jun	Jul	Aug	Sep	Oct	Nov	Dec
Poor health												
Poor access to latrines, pits, etc.												
Poor drainage												
Large amount of waste												
Low availability of water												
Lack of building materials												

12.6.4 Discussions

The most common participative activity is discussion; this may take place in focus groups (women, community leaders, burial committee, etc.) or in more general meetings. The job of the facilitator is to focus and steer these discussions.

12.7 Problem-tree analysis

During the later stages of an emergency, communities may be actively involved in problem-tree analysis. This is an interactive process whereby the community members identify existing problems, formulate objectives and select appropriate actions. This can be conducted in group meetings involving all the key stakeholders.

12.7.1 Problem analysis

Before selecting specific actions, it is important that stakeholders identify and give their weighting to existing problems that need to be addressed, or potential problems that may affect the development of the programme. This may be achieved through a ranking exercise such as that described above. They can then develop these problems into objectives which can be used in action selection. It is suggested that this be done by the community planning team for each relevant sanitation sector individually.

Firstly, all stakeholders should be asked to identify what they consider to be the ‘core’ problem for that particular sector. This should be followed by discussion by the group to agree on a single core problem.

The team should then be asked to identify substantial and direct *causes* for the core problem and these should be placed on a diagram parallel to each other underneath the core problem. The substantial and direct *effects* of the core problem should then be identified and placed on the diagram parallel to each other above the core problem. A simplified example is illustrated in Figure 12.1.

EMERGENCY SANITATION

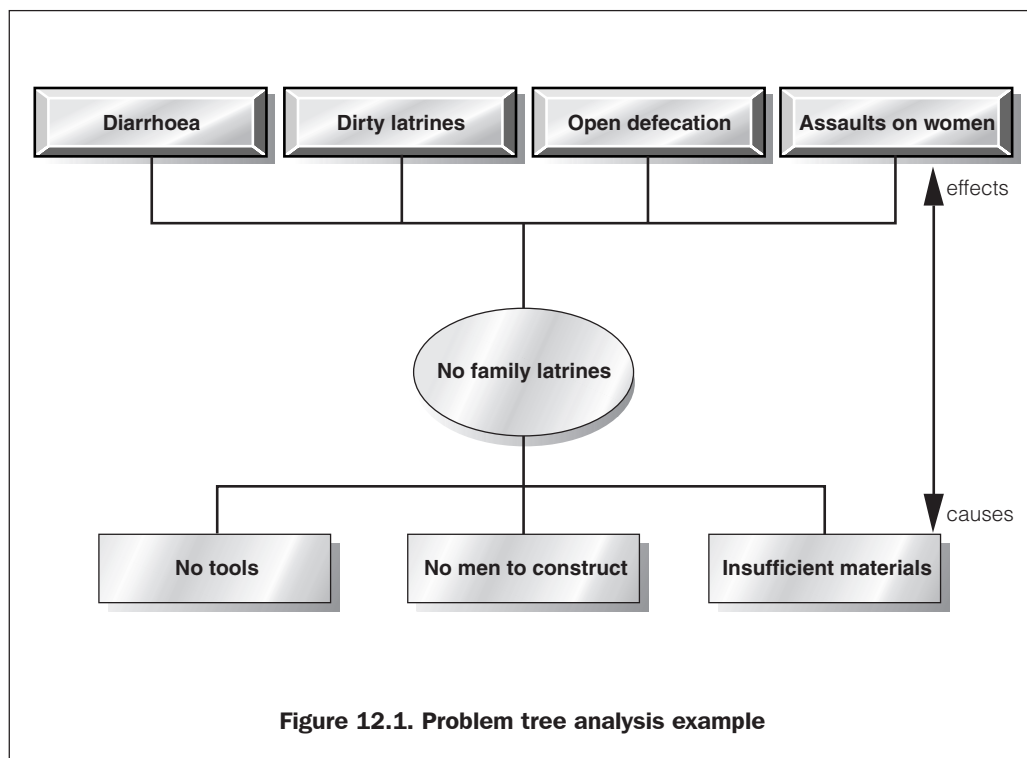

Causes and effects can then be further developed along the same principle so that multi-level casual links and branches are created.

12.7.2 Objectives analysis

The problem tree produced through the problem analysis process can be transformed into a hierarchy of objectives. This is done by rewording all the problems in the tree (including the core problem) and making them into objectives.

In this way, an objectives tree can be produced, in which cause–effect relationships have become means–end relationships. Figure 12.2 shows the expanded example.

12.7.3 Action selection

From the list of objectives key actions to satisfy these must be selected. The facilitator can help group participants by providing a range of options from which to choose and outlining the key advantages and constraints of each.

Using the above example community members would decide what type of family latrine to construct, what materials should be used, how tools and materials will be managed, and who will be responsible for construction.

COMMUNITY PARTICIPATION

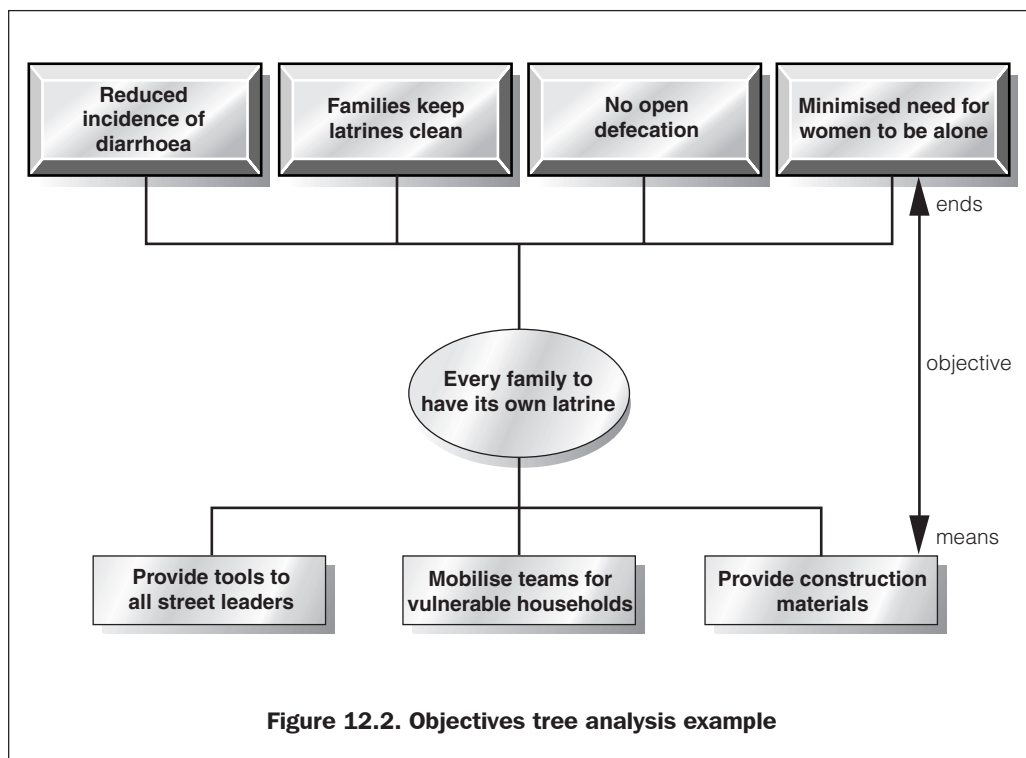

Figure 12.2. Objectives tree analysis example

12.8 Finance

In most externally-assisted emergency relief programmes there is no element of community-managed finance, yet that is not to say that communities cannot participate in the generation and management of finances. It is interesting to note that most emergencies worldwide have no external assistance at all and are therefore completely locally funded and managed. Where programmes are externally assisted, generally the implementing agency takes responsibility for procuring and managing funds and the community is neither expected to contribute nor have any direct involvement in how this money is spent. In the immediate stages of an emergency such an approach is probably the only option. However, as emergency programmes evolve and become long-term, this arrangement can gradually change.

12.8.1 Finance generation

Community participation can also include finance generation activities and this may be a key starting point in giving communities greater responsibility, removing dependence on external support and promoting sustainability. In many emergency situations the affected community soon initiates some economic activity through trade and service provision. This may include setting up food markets, hairdressers or tailors, and the activities are built on existing skills and needs within the community.

By promoting such activity finance can be generated within the community which can lead to greater independence and allow people to contribute to programmes financially.

12.8.2 Cost recovery

Cost recovery is a key aspect of many development projects but is rarely applied in a relief setting. Once finance generation activities are set up within a community it may be possible to recover some programme costs from primary stakeholders. One simple example of how this can be done is to charge market stallholders a small levy which pays for the cost of managing the solid waste generated at the market. The monies collected can be used to pay workers and replace tools and facilities. Such a system can be managed wholly by the market workers themselves through the formation of a market committee and thereby removes continued reliance on the agency and gives the community greater autonomy. A similar system could be used to maintain communal latrines in the vicinity.

Unfortunately, it is beyond the scope of this book to address these issues in greater detail but appropriate references are given below.

References and further reading

- Adams, John (1999) *Managing Water Supply and Sanitation in Emergencies*. Oxfam: Oxford.
- Ahmed, M. Feroze and Jahan, Hasin (2000) *Participatory Management of Low-cost Water Supply and Sanitation*. ITN-Bangladesh.
- Gajanayake, Stanley and Gajanayake, Jaya (1993) *Community Empowerment: A participatory training manual on community project development*. Office of International Training and Consultation: Dekalb, Illinois.
- Gosling, Louisa and Edwards, Mike (1995) *Toolkits: A practical guide to assessment, monitoring, review and evaluation*. Save the Children: London.
- Goyet, Claude d.V.d. (1999) *Stop Propagating Disaster Myths*. Pan American Health Organisation: Washington. (<http://www.paho.org>)
- GTZ (1988) *ZOPP in Brief: Objectives-oriented project planning*. Deutsche Gesellschaft für Technische Zusammenarbeit (GTZ): Eschborn.
- Phiri, Samuel (2001) (Hygiene Promotion Co-ordinator, Médecins Sans Frontières, Zambia) Personal communication (Interview).
- Rietbergen-McCracken, J. and Narayan, D. (compiled by) (1998) *Participation and Social Assessment: Tools and techniques*. The International Bank for Reconstruction and Development / The World Bank: Washington D.C.
- Smout, Ian; Samson, Kevin; Coates, Sue & Snel, Marielle (2000) *Community and Management: A postgraduate distance learning module*. WEDC, Loughborough University: UK.
- Svendsen, Dian Seslar; Foster, Pam & Sartorius, Rolf (1998) *Facilitation Skills: An introductory guide*. Project Concern/Social Impact: USA.
- UNCHS (1986) *Community Participation in Low-cost Sanitation*. United Nations Centre for Human Settlements (Habitat): Nairobi.

Chapter 13

Programme design

This Chapter is designed to describe each element of programme design. It also describes how these can feed into a programme proposal although different agencies have different models for this.

13.1 Programme summary

It is important that any programme design or proposal contains a summary description of the overall programme. This should contain the:

- background information;
- programme justification; and
- proposed intervention programme.

13.1.1 Background information

Background information should describe the nature of the emergency including relevant history, causes and effects. This description may include natural and man-made phenomena, such as climatic and political data. The purpose of this is to set the background to the current crisis so that the programme can be viewed in relation to the broader context.

13.1.2 Programme justification

The programme justification is an explanation of why humanitarian intervention is required and why the donor should release funds to support this. Any justification should focus on the actual and potential vulnerabilities of the affected population. Therefore, past and current effects should be described and likely future effects predicted.

13.1.3 Proposed intervention programme

A summary of the overall intervention proposed should be clearly stated. This should describe the overall objectives of the programme and the key activities planned. The amount of information contained here will depend on the stage of programme design. For example, the outline (or initial draft) programme design may simply state that communal latrines and solid waste pits are to be provided; while the detailed design may describe the types of latrine and solid waste management system proposed.

13.2 The Logical Framework

The Logical Framework (log-frame) is a useful tool for planning and defines clear objectives (goal and purpose), outputs, inputs and activities. Measurable indicators are those factors which can actually be measured to test the logic and determine the progress of a programme, and the means of verification are how these are determined. The terms used within this framework may differ slightly between organisations but the overall format is the same. A log-frame can also be very useful for planning budgets and for monitoring and evaluation.

Table 13.1 shows a general example of what could be included in a logical framework for an integrated sanitation programme.

Table 13.1. Generalised logical framework			
Narrative summary	Measurable indicators	Means of verification	Important assumptions
Goal: Raise and sustain the well-being of the affected population through cost-effective improved sanitation within first year of emergency	Improved health and well-being of the affected population and a cleaner environment	Health and environmental impact studies	Easy access to affected population; socio-political stability in the affected area
Purpose: To improve and sustain the health and well being of the affected population through improved excreta disposal, solid waste management, medical waste management, wastewater disposal and hygiene practices	Mortality and morbidity rates for sanitation-related diseases, cleaner physical environment in the affected and surrounding area	Mortality and morbidity records from health centres, cemeteries and cremation sites; through interview with affected population, observation of facilities and environment	The demand for appropriate safe excreta disposal, solid waste management, medical waste management, wastewater disposal and hygiene promotion in affected areas continues; and major cause of mortality and morbidity is sanitation-related disease
Output: According to time-scale (short and long term) recommended minimum objectives for all sanitation sectors in place	Quantity, quality and usage of facilities	Observation and monitoring of facilities in the affected area; and repeat assessments	Availability of sufficient funds; availability of personnel, tools, equipment and materials; acceptability of systems to the affected population; all stakeholders including local and national authorities in favour of programme
Activities: 1. Identification, recruitment and training of personnel for both hardware and software aspect of programme	1. Number of personnel trained	1. Personnel records	Permission from host nation for recruitment

PROGRAMME DESIGN

Table 13.1. continued....

<i>Narrative summary</i>	<i>Measurable indicators</i>	<i>Means of verification</i>	<i>Important assumptions</i>
2. Repair and improvement of existing sanitation facilities where required	2. Quality, quantity and usage of improved facilities	(2-8) Monitoring and repeat assessments: Observation, focus group discussions, meetings, interviews and programme records	Availability of space, agreement of host nation and support of affected population
3. Construction of new sanitation facilities that are safe, acceptable and accessible to all members of the affected population to satisfy short-term objectives	3. Quality, quantity and usage of new facilities		Availability of local materials without adverse effect on the local environment
4. Continuation of work to achieve long-term objectives	4. Quality, quantity and usage of new facilities		Socio-cultural aspects considered in design
5. Promotion of facilities through hygiene promotion activities	5. Awareness of hygiene promotion messages among affected population		Hygiene promotion messages are compatible with socio-cultural aspects of affected population
6. Capacity building through training programme	6. Level of participation (especially of women)		Appropriate training provided for local staff
7. Affected population involvement in all aspects of programme	7. Proportion of affected population (individuals and groups) involved at different phases of programme		Expatriate and local staff are able to carry out their tasks in a safe environment
8. Setting up Operation and Maintenance (O&M) teams	8. Level of user-satisfaction; state of facilities		Affected population (especially members of vulnerable groups) are able to use facilities without fear at all times
Inputs:	Tools Construction materials Hygiene promotion materials O&M materials Equipment for solid and medical waste management Staff salaries		Logistics records for tools and materials Financial records

EMERGENCY SANITATION

The problem-tree analysis (12.7) can be used to help develop a logical framework by developing the problem into the purpose, causes into activities and outputs, and effects into measurable indicators.

13.3 Activity plan

Using the log-frame as a basis, a simple activity plan can be developed rapidly by listing the desired programme outputs and all the necessary activities required to achieve these outputs. Table 13.2 shows a completed example.

Table 13.2. Example activity plan	
<i>Planned output</i>	<i>Necessary activities</i>
Family latrines for all population	Procure construction materials: tools, sand, gravel, cement, reinforcement, timber; recruit and train construction staff; commence latrine slab construction; commence hygiene promotion programme (see below)
Communal solid waste bins and off-site disposal by landfilling	Procure bins and clothing; identify disposal site; procure wheelbarrows and truck; train workers
Medical waste system with general pit, sharps pit and burner	Procure segregation containers; train staff; procure construction materials: tools, sand, gravel, cement, reinforcement, oil drum; construct sharps pit; construct burner
Cremation service accessible to all	Identify and designate fuel sources; identify cremation sites
Soakpits provided at all waterpoints	Excavate pits; procure gravel and drainage pipes; construct soakpits
Hygiene promotion programme to focus on family latrine programme	Train staff; meet with community leaders; hold focus group meetings; conduct house visits

PROGRAMME DESIGN

13.4 Programme Gantt chart

A Gantt chart (or bar chart) should generally be used to show the order and duration of the programme activities determined in the activity plan. A typical example of a programme Gantt chart for the first month of the above activity plan is shown in Table 13.3. The shaded area indicates the period for each activity.

Table 13.3. Example Gantt Chart				
	<i>Week number</i>			
	1	2	3	4
Procure construction materials: tools, sand, gravel, cement, reinforcement, timber	Shaded			
Recruit and train construction staff	Shaded			
Latrine slab construction	Shaded	Shaded	Shaded	Shaded
Procure bins and protective clothing; identify disposal site; procure wheelbarrows and truck	Shaded			
Recruit and train solid waste workers		Shaded		
Procure segregation containers and oil drum	Shaded			
Train medical and cleaning staff in waste management procedures		Shaded		
Construct sharps pit and burner		Shaded	Shaded	Shaded
Identify and designate fuel sources and cremation sites	Shaded	Shaded		
Procure gravel and drainage pipes for soak pits	Shaded	Shaded		
Excavate and construct soakpits		Shaded	Shaded	
Recruitment and training of hygiene promoters		Shaded	Shaded	
Hygiene campaign to promote family latrine and safe excreta disposal (meetings and house visits)		Shaded	Shaded	Shaded
Monitoring and supervision of activities	Shaded	Shaded	Shaded	Shaded

EMERGENCY SANITATION

13.5 Personnel

Once the activities have been decided upon it is important to consider the personnel required in order to conduct these activities. Table 13.4 shows an example of a simple human resource plan.

Table 13.4. Example human resource plan

<i>Job title</i>	<i>Responsibilities</i>	<i>Reporting line</i>	<i>Contract details</i>
Sanitation supervisor	Overall management of sanitation programme	Programme co-ordinator	Six-month contract, International grade 1A
Hygiene promotion co-ordinator	Overall management of hygiene promotion programme	Programme co-ordinator	Six-month contract, International grade 1A
Hygiene promoters	Promoting good hygiene practice through house visits and community meetings; monitoring of sanitation facilities and their use; provision of tools	Hygiene promotion co-ordinator	Two-month contract, National grade 1B
Solid waste workers	Bin emptying and maintenance; transportation to and operation and maintenance of disposal site	Sanitation supervisor	Two-month contract, National grade 1A
Construction workers	Excavation of pits for communal latrines, soakpits and solid waste; management of tools	Sanitation supervisor	Two-month contract, National grade 1A
Latrine slab constructors	Construction of latrine slabs; transportation and monitoring of materials	Sanitation supervisor	Two-month contract, National grade 1A

PROGRAMME DESIGN

13.6 Implementation plan

An implementation plan can be used to combine the activity plan and human resource plan, and so enable additional resources required to be identified. These resources may include equipment (e.g. tools) and materials (e.g. for construction), as well as appropriate facilities and services. Table 13.5 shows a completed example.

<i>Activities</i>	<i>Responsibilities</i>	<i>Equipment and materials</i>	<i>Facilities</i>	<i>Services</i>
Family latrine construction	Sanitation supervisor; latrine slab constructors; hygiene promotion team; families	Pick axes; shovels; sand; gravel; cement; reinforcement; timber	Slab construction workshop	Logistics department
Solid waste bin collection	Sanitation supervisor; solid waste workers	Bins; overalls; wheelbarrows; gloves; boots; shovels; truck	Transfer station; changing area	Logistics department
Medical waste management	Sanitation supervisor; medical and cleaning staff	Segregation containers; gloves; overalls; boots; oil drum; tools; sand; gravel; cement; reinforcement; timber	Handwashing and disinfection facilities, changing area	Logistics department
Cremation service	Sanitation supervisor; families	Firewood/fuel; body cloths; matches	Morgue	Logistics department
Soakpits construction	Sanitation supervisor; construction workers	Pick axes; shovels; sand; gravel; cement; drainage pipes	Transportation for gravel	Logistics department
Hygiene promotion programme	Hygiene promotion co-ordinator; hygiene promoters	Posters; stationary; books; audio-visual aids	Training place; meeting places	Logistics department

13.7 Costs and budget

A detailed budget presenting estimated costs for resources and activities should be prepared; this is necessary for most programmes before they are approved. The budget may also include a contingency line, which is 5-10 per cent of the total budget, to allow for unforeseen needs, however not all donors will accept this. An example of a typical budget outline for a sanitation programme is shown in Table 13.6.

EMERGENCY SANITATION

Table 13.6. Example sanitation budget

No.	Description	Unit cost	No of units	Total cost
	Hygiene promotion			
1	Purchase of promotional materials and audio-visual aids			
2	Construction of meeting places			
3	Hygiene kits			
4	Stationery			
5	Protective clothing			
6	National staff salaries (facilitators, facilities attendants, artist, translators, etc.)			
7	Hygiene promotion co-ordinators (Int.)			
8	Hygiene promotion co-ordinators (Nat.)			
9	Vehicles			
10	Operation and maintenance of vehicles			
11	Workshop and training			
12	Communication equipment			
13	Accommodation			
14	Travelling expenses/subsistence			
	Excreta disposal			
15	Purchase of tools and equipment			
16	Purchase of materials			
17	Construction of temporary latrines (equivalent of contract price)			
18	Construction of permanent latrines (equivalent of contract price)			
19	Repair of existing facilities			
20	Maintenance and operation of facilities (equivalent of contract price)			
	Solid waste management			
21	Purchase of tools and equipment			
22	Purchase of refuse containers			
23	Off-site disposal of waste (equivalent of contract price)			
24	Collection of waste from public places			
25	Operation and maintenance (equivalent of contract price)			
	Wastewater management			
26	Purchase of tools and equipment			
27	Construction of wastewater system for all hygiene facilities (equivalent of contract price)			
28	Maintenance and operation			
	Staff costs			
29	Engineer (Int.)			

Table 13.6. continued.....

No.	Description	Unit cost	No of units	Total cost
22	Purchase of refuse containers			
23	Off-site disposal of waste (equivalent of contract price)			
24	Collection of waste from public places			
25	Operation and maintenance (equivalent of contract price)			
Wastewater management				
26	Purchase of tools and equipment			
27	Construction of wastewater system for all hygiene facilities (equivalent of contract price)			
28	Maintenance and operation			
Staff costs				
29	Engineer (Int.)			
30	Engineer (Nat.)			
31	Masons, carpenters, labourers, drivers, translator, etc.			
General				
32	Vehicles			
33	Operation and maintenance			
34	Communication equipment			
35	Accommodation			
36	Travelling expenses/subsistence			
37	Setting up of workshop			
Office back up				
38	Rent of office space			
39	Furnishings			
40	Stationary and office supplies			
41	Office running cost			
42	Communication equipment			
43	Office manager, office assistant, translators, security guards, cleaners, etc.			
	Sub total			Sum of total costs (1)
44	Contingencies			10% of sub-total (2)
	TOTAL			(1)+(2)

EMERGENCY SANITATION

Some donors may require less detailed budgets whilst others are keen on the projected cost per beneficiary.

$$\text{Cost per beneficiary} = \frac{\text{total cost of sanitation programmes}}{\text{total number of beneficiaries}}$$

This can also be broken down into cost per beneficiary for individual sanitation sectors or activities.

13.8 Proposal writing

Proposal writing is an important skill. A proposal is a way of presenting the programme design in order to satisfy the intended donor that the proposed programme has a strong humanitarian objective and has been carefully thought through. The proposal should demonstrate that the programme will address the priority needs of vulnerable people, and will be efficient and cost-effective.

13.8.1 Structure

Proposal structures vary between donors but generally the following information should be included:

- Programme summary
- Logical framework
- Gantt chart
- Human resource plan
- Implementation plan
- Proposed budget

Each of these sections has been described within this Chapter.

13.8.2 Funding criteria

To write successful programme proposals it is essential that the funding criteria of the intended donor are fully understood. Some donors have specific Mission Statements which dictate and limit the types of programme they are prepared to fund. Proposal writers should ensure that they are fully conversant with donor requirements.

References and further reading

- Adams, John (1999) *Managing Water Supply and Sanitation in Emergencies*. Oxfam: Oxford.
- Davis, Jan and Lambert, Robert (1996) *Engineering in Emergencies: A practical guide for relief workers*. RedR / IT Publications: London.
- Gajanayake, Stanley and Gajanayake, Jaya (1993) *Community Empowerment: A participatory training manual on community project development*. Office of International Training and Consultation: Dakalb, Illinois.
- House, Sarah and Reed, Bob (1997) *Emergency Water Sources: Guidelines for Selection and Treatment*. WEDC, Loughborough University: Loughborough.

Chapter 14

Implementation

This Chapter is designed to provide basic information concerning implementation, including details of monitoring and evaluation. These topics are not covered in great detail and appropriate references for further reading are given at the end of the Chapter.

14.1 Implementation framework

The seven key components of implementation are:

- Staff
- Resources
- Finances
- Time
- Outputs
- Community
- Information

These provide an appropriate framework for implementation, monitoring and evaluation. Each component is described in more detail below.

14.2 Staff

Staff form an integral part of any programme and the make-up of a team can have a major influence on the overall success of the programme.

14.2.1 Recruitment

Recruitment procedures may need to be instigated rapidly but selection criteria should always be developed clearly. Agencies should seek to achieve a national staff majority at all levels where possible. Skilled and unskilled staff from within the affected community should also be recruited where appropriate. The importance of communication must be considered and language barriers may pose considerable constraints. For this reason a good interpreter should be recruited as soon as possible in most situations. Job descriptions should be provided and employment contracts drawn up in accordance with local legal requirements.

EMERGENCY SANITATION

Some agencies may prefer to recruit ‘volunteer’ staff, especially from within the affected community, and different management, remuneration and support arrangements may be needed for these groups.

14.2.2 Remuneration

It is important that external agencies set up local salary scales in relation to existing national salaries. Where possible all humanitarian actors (NGOs, UN agencies, bilateral agencies, etc.) should agree uniform local salary structures to minimise conflict between and within agencies. The long-term effects should also be considered; for example, once the external agency has left, some staff may work for the government or local organisations, and consistent salaries are likely to minimise problems in this transfer.

In some circumstances it may be appropriate to pay workers in food (staple foods or luxury items) rather than money. This is normally a short-term measure and is likely to be most appropriate where there are limitations concerning the use of local currency.

14.2.3 Training and capacity building

Once staff are recruited they are likely to require training specific to the current situation. Some staff may have limited emergency experience and this should be recognised through the provision of appropriate briefing and training activities.

Wherever possible, agencies should seek to build capacities within local and displaced communities. Training activities may therefore be used to contribute to longer term goals, in addition to the success of the current programme.

Security is likely to be a major consideration in conflict zones and it is essential that all staff receive appropriate security training on issues such as anti-personnel mines, unexploded ordnance and armed hold-ups.

14.2.4 Supervision and appraisal

It is important that staff are supervised at all levels and that there is a degree of monitoring of their performance. Appraisal procedures should also be set up, especially in long-term programmes, and criteria used for appraisal should be clearly defined.

14.2.5 Conflict resolution

Conflicts between individuals or teams can cause huge problems in implementation. For this reason, conflicts should be identified and remedied at the earliest possible stage. Responsibility for this will ultimately lie with the programme manager.

14.3 Materials and equipment

14.3.1 Sources

The golden rule for resource procurement is ‘use locally available materials and tools wherever possible’. The reasons for this are twofold - to stimulate and contribute to the local

IMPLEMENTATION

economy, and to avoid extensive delays caused by ordering, purchase and transportation of resources from international sources.

14.3.2 Quality

The quality of goods must be balanced against speed of procurement and cost. The intended design-life must be considered along with the degree of urgency for implementation. In most scenarios local low-cost resources of poor quality are preferable to high-cost, high-quality goods that need to be shipped or flown into the affected area. The consequences of using poor quality resources must be weighed against time and cost constraints.

14.3.3 Logistical procedures

Logistics is perhaps the most important component of any emergency relief programme. Programme activities can only be conducted if necessary resources are available or can be made available. It is important that procedures for requesting, purchasing and transporting resources are simple and clear to all staff.

In designing and managing an effective programme good communication and co-operation between logistics and technical/hygiene teams is essential. Planners must be aware of logistical constraints, procedures and options, whilst resource requirements and specifications must be clearly conveyed to logisticians.

14.4 Finances

Sound financial management is a key component of any programme and some responsibility for this is likely to lie with field practitioners as well as accountancy staff.

14.4.1 Budgeting

In preparing budgets generous margins should always be made to allow for contingency plans. Such plans may be necessary as a result of an increase in the number of beneficiaries, economic or political change, or security problems.

In all budget plans it is important that estimated operation and maintenance costs are considered as well as procurement and construction costs. In most situations it is best to budget for the long term, as it is likely to be easier to secure funds in the earlier stages of an emergency.

14.4.2 Financial control

During implementation it is important to monitor cash flow and compare expenditure with amounts budgeted. It is also important to compare expenditure with activities and outputs achieved. Careful management of invoices and receipts is essential to this process and where a receipt is unavailable expenditure must always be recorded.

On-going financial monitoring will enable field staff to warn the agency headquarters if advanced funds are likely to be required. In addition, regular checks on the programme budget lines will be useful in making early changes to the programme if required.

14.5 Time

All other implementation components are governed by time and yet can also influence the rate of implementation. In most emergency programmes there is a large degree of urgency, and consequently time is of the utmost importance in all programme activities. For this reason it is essential that time is managed effectively and that activities are prioritised.

14.5.1 Logistics

The biggest single time constraint in many situations is logistics. This is largely unavoidable and yet can cause much frustration, resentment and even aggression among agency staff. Sometimes small items are required which may have a large influence on the beneficiaries; the delay in obtaining such an item can be very frustrating yet responses to logistical 'delays' should remain reasonable and measured.

Technical staff sometimes consider logistics as a simple question of walking into a shop and buying something, when often procedures are much more complicated than this. The time taken to communicate with suppliers, obtain funds, procure goods, arrange consignment, transport goods, clear customs and distribute to the field, can easily add up. This is especially the case where reliance is placed on expensive items from international sources.

Important ways in which field staff can ensure that time is not wasted are to:

- take time to specify required items clearly and unambiguously - include diagrams and give more information rather than less;
- order all components of a particular system at the same time - consider operation and maintenance (spare parts, tools, etc.);
- look at different options including local alternatives and short-term improvisations;
- plan activities in stages and allow realistic time-frames for logistical procedures; and
- keep on good terms and communicate regularly with the logistics team - they are likely to be your lifeline!

14.5.2 Breakdown of activities

A key element of managing time is the breakdown of activities into short, distinct time-bound targets. This helps to detect areas behind schedule early and to keep implementation plans simple and achievable.

Time-bound targets should be set for staffing, resources, finances, outputs, community participation and information exchange (reports, meetings, etc.).

14.5.3 Supervision and monitoring

By supervising and monitoring activities it can be assessed whether activities are being implemented to plan and on schedule, and if not, why not. The use of monitoring across all programme sectors can have a major positive effect on the overall progress.

14.6 Outputs

The primary focus of implementation is inevitably the actual outputs achieved. These can include completed facilities or services, effective operation and maintenance systems and improvements in hygiene practice. These should lead to the ultimate outcome, which is the raised and sustained health and well-being of the affected population.

IMPLEMENTATION

14.6.1 Facilities

Completed sanitation facilities are the main focus of a significant part of most sanitation programmes. All too often, however, scant attention is paid to on-going operation, use and maintenance of completed facilities. The quality of facilities can only be assessed by determining whether and how they are being used. This requires regular inspection and monitoring.

14.6.2 Operation and maintenance

Operation and maintenance (O&M) activities and systems are as important as design and construction actions. For this reason O&M should be considered at all stages of programme design and implementation. Successful O&M systems should be as much desired outputs as physical facilities themselves.

14.6.3 Health and hygiene

Improvements in health and hygiene are difficult to quantify and a reliance on morbidity and mortality figures alone may be misleading. However, these can act as useful indicators and can be combined with monitoring hygiene behaviour through interview, discussion and observation.

14.7 Community

Although community participation methods and principles are dealt with in Chapter 11 it is worth re-iterating that emphasis should be given to community issues.

14.7.1 Decision-making

Ways in which community members may be involved in programme development and decision-making should always be considered. Community involvement should be much more than digging pits or cleaning latrines.

14.7.2 Participation

Most community participation occurs in construction, operation and maintenance activities. Whilst this in itself is not a problem it is important that participation is not limited to these components which focus on cheap unskilled labour provision, rather than empowerment and capacity building.

14.7.3 Capacity building

Ways in which to promote and sustain the capacity and self-sufficiency of the affected community must continually be sought. Only through inviting the community to be involved in different aspects of the programme will it be possible to establish how this may be done. For this reason, plans may need to be adapted with time, as training and resource needs are identified.

14.8 Information

It is important to develop an information flow system that runs through the technical team, hygiene promotion team, logistics and finance. This ensures that each component of the programme is kept up to date on the activities of others and that the overall programme is monitored on all fronts.

14.8.1 Reports

A simple method of ensuring good information flow is to develop reporting formats and schedules. Reporting formats should be designed so that they reflect the real situation in the field and give information on both quantity and quality of hardware and software components (see 14.12).

14.8.2 Meetings

It is good practice to develop a regular meeting plan with the team and other key stakeholders. These meetings should not just consist of ‘information exchange’ but should be such that reports prepared by different teams feed into the implementation process on the ground.

14.8.3 Plans

Information from reports and meetings will only be useful if fed into future implementation and contingency plans. Planning should be on-going and flexible, to ensure that lessons are learnt and mistakes are not repeated.

14.9 Programme management

The previous sections have outlined the key components of implementation but a common problem affecting emergency relief programmes is ineffective management of these. Programme management can be defined as the planning, organisation, monitoring and control of all implementation components. This must, however, be coupled with motivation of all those involved in a programme to achieve its objectives. The management and co-ordination of activities is necessary to:

- achieve the programme objectives and targets;
- take immediate corrective actions for problems encountered;
- promote better communication among technical and hygiene staff in order to harmonise resources and activities for the achievement of project objectives; and
- establish communication between the affected population and other stakeholders.

The programme co-ordinator or manager is responsible for ensuring that these aims are met. The key roles of any manager are to:

- plan;
- lead;
- organise;
- control; and
- motivate.

Management can involve any or all of the following:

- Self-management
- Recruitment and training
- Motivation and supervision
- Contract negotiation

IMPLEMENTATION

- Conflict resolution
- Information and record keeping
- Communication and report writing
- Financial management

This is not an exhaustive list and further information regarding management can be found in Davis and Lambert, 1996. A good manager should, however, be adept at each of these and adopt a management style suitable for the current situation. For example, in the immediate stage of an emergency it may be appropriate to adopt a directive management style, whereby decisions are made rapidly with minimum input from subordinates. It is unlikely that such an approach would be appropriate in later stages of the programme, however, where a more consultative style may be more effective. Therefore, a flexible management style is likely to be necessary.

14.9.1 Managing implementation

A simple way to manage programme implementation is to use implementation milestones. This technique can be used with a multidisciplinary management team and usefully feeds into the monitoring process. A milestones table should be produced for each intended project output in the logical framework. Each table lists time-bound specific targets or ‘milestones’ which are necessary to achieve the project output. The table also includes who is responsible for achieving each milestone and when they should be completed. The final column is to be used by the management team to monitor programme progress, identify any problems or constraints, and make changes to implementation plans and time-frames.

Table 14.1 shows the typical framework for a milestones table with examples of the type of milestones and responsible bodies that may be included. A completed example is presented in the Case Study (Table C8).

<i>Selected milestones (general examples)</i>	<i>Who</i>	<i>When (date)</i>	<i>Current status and com- ments</i>
Recruitment	Agency staff		
Training activities	Agency staff		
Resource procurement	Logistics team		
Hygiene promotion activities	Hygiene promotion team; Community		
Construction activities	Construction team Community		
Monitoring activities	Agency staff; Community Other agencies		

14.9.2 Contingency planning

A key aspect of managing an emergency programme is the ability to undertake contingency planning for unforeseen events. In any emergency situation, it is difficult to plan for everything and impossible to predict exactly what will happen during the implementation phase. It is worth considering what assumptions have been made during programme design, and what is likely to happen if these assumptions prove to be wrong.

Whilst it is not necessary to make detailed contingency plans, it is good practice to consider possible emergency situations such as an influx of a large number of refugees, an outbreak of cholera or an increased security threat. Contingency plans may include:

- Training: appropriate training of staff in contingency procedures
- Equipment: local storage of small stocks of equipment in case of emergency
- Sites: identification of possible sites for relocation/settlement of refugees
- Logistics: identification of most efficient transport types and access routes

14.9.3 Co-ordination

One common problem in sanitation programmes is the lack of communication and collaboration between technical staff and hygiene promotion staff. This is largely a result of the fact that personnel with different professional backgrounds and interests are usually employed for each. This book takes the approach that hygiene promotion activities are an essential part of any sanitation programme and hence all activities should be integrated from the onset of implementation. Integration of personnel and cross-sectoral activities are key factors in achieving this aim.

It is also essential that there are good communication links between the affected community and other stakeholders, in order to avoid conflict and promote co-operation. These links should be co-ordinated by the programme manager.

The manager may also be responsible for co-ordination with other programmes and agencies working in the programme area. Ideally, different activities within the same agency should be integrated, and co-operation or collaboration with other agencies should be encouraged where possible. Integrated programmes may include sanitation, hygiene promotion, water supply, food distribution and health care activities.

14.10 Monitoring and evaluation

Monitoring and evaluation are tools used to assess whether the agency's actions are going to plan, and what the impacts of these actions are. Monitoring and evaluation can be used to:

- assist in the planning process;
- identify whether any readjustment to a programme is required;
- determine the progress of a programme; and
- provide a measure of overall success or failure.

Monitoring and evaluation are often seen by field staff as simply exercises to please the agency headquarters or the donor. However, if they are used properly they can be useful tools to support and improve programme performance.

IMPLEMENTATION

14.10.1 Reasons for monitoring and evaluation

Monitoring and evaluation will:

- save you time in the long-run;
- ensure that you know what you are doing or trying to do; and
- help you keep track of where you are and where you are going.

Monitoring and evaluation can tell you:

- if you can meet demand;
- if you need to change plans, goals or time-frames; and
- if your actions are having the desired effect.

Monitoring and evaluation:

- provide useful information for reports, replacement staff, etc.; and
- allow us to learn from our mistakes.

14.11 Monitoring methods

Monitoring aims to determine whether implementation targets are being met according to plan and if not how the programme needs to be adjusted. Monitoring should be an on-going process which starts in the immediate phase of an emergency and continues indefinitely. It facilitates programme change in changing situations. The following sections describe different monitoring methods and give examples of how these can be applied to the same situation.

14.11.1 Monitoring framework

Table 14.2 represents a monitoring framework tool produced for the Guidelines. This is used by answering the key questions for each implementation component. This exercise can form the basis for monitoring reports (see 14.12).

14.11.2 SWOT analysis

SWOT (Strengths, Weaknesses, Opportunities and Threats) analysis can be conducted through brainstorming by all key stakeholders under the following headings:

- Strengths: Those things that have worked
 Weaknesses: Those things that have not worked so well or could be improved
 Opportunities: Conditions which are favourable and can be taken advantage of by the programme
 Threats: Threats which reduce the range of opportunities for improvement

The purpose of this exercise is to provide a rapid summary of the key positive and negative aspects of the programme to date. This should help participants to focus on programme successes and how to sustain them, and weaknesses and how to overcome them.

The key components of implementation can be used to inspire feedback. A completed example of a SWOT analysis is reproduced in the Case Study (Table C10).

EMERGENCY SANITATION

Table 14.2. Monitoring framework

Implementation component	Monitoring data
Staff	<p>Has the target number of staff been recruited and trained? Does this include skilled staff from within the affected community? How are staff selected and trained? Is training on-going? Are staff supervised and appraised? Are staff working effectively and efficiently? Are there any personnel problems or conflicts?</p>
Resources	<p>Are appropriate resources procured and used as planned? Are logistical procedures clear and efficient? Is there regular feedback on order status from the logistics department? Is there a need for any additional resources? Are local materials used where possible? Are there any detrimental environmental effects?</p>
Finances	<p>Has the budget been kept to so far, and if not why not? How does expenditure compare with each budget line forecast? Is there regular feedback from the finance department? Are there any significant unforeseen costs or savings?</p>
Time	<p>Are activities being implemented according to schedule and if not why not? Is time managed efficiently? Are there any unforeseen time constraints?</p>
Outputs	<p>Are the targets for facilities and hygiene promotion being met, if not why not? Has the overall health of the population improved? Are benefits spread equally among the affected population, is anyone excluded? Are the outputs sustainable? Are there any relevant needs which have not been addressed? Are there any unforeseen effects caused by the programme?</p>
Community	<p>Is the community actively involved in design, construction, operation and maintenance? Are all facilities being used and if not why not? Have hygiene practices improved? Are there any capacity building activities for the community? Are there any conflicts between the community and other stakeholders?</p>
Information	<p>Are regular reports and plans produced and disseminated? Is information from reports fed back into the implementation process? Are meetings held regularly with key stakeholders? Are activities co-ordinated between teams? Are activities co-ordinated between implementing agencies? Is technical support and information available if required?</p>

IMPLEMENTATION

14.11.3 Log-frame analysis

Logical framework analysis can be conducted by using the measurable indicators identified in the logical framework produced at the planning stage. Each indicator can be used to test whether the programme has achieved the planned outputs, and this is recorded in the final column 'Recorded information'. Table 14.3 shows an example used for a monthly review of a hygiene promotion programme.

Narrative summary	Measurable indicators	Means of verification	Recorded information
Goal:	Crude mortality rate Crude morbidity rates: malaria; diarrhoea; dysentery; cholera; scabies	Monitoring reports and records from MSF medical team	Crude mortality rate, malaria and diarrhoea decreased; scabies increased
Purpose:	Improved hygiene behaviour and awareness of hygiene and sanitation issues Improved access to and use of appropriate sanitation facilities by affected population Increased community involvement in sanitation activities Improved construction, operation and maintenance of sanitation facilities following promotion campaigns Hygiene promotion campaigns directed at all groups within the camp, especially the vulnerable Hygiene promotion programme active in all areas of the camp	1.1 Feedback from hygiene promoters (notebooks), from MSF sanitation and health teams and from project monitoring and evaluation 1.2 Feedback from affected community through interview and discussion	All measurable indicators for programme purpose have been realised, although improvements are on-going (see outputs and activities below)
Outputs:	1. All households visited by hygiene promoters within one month 2. All section leaders to have shovel, pick and hoe, and five buckets per street within two weeks 3. One hygiene promoter per 800 people and one supervisor recruited from refugee population	1.1 Feedback from hygiene promoters, from MSF sanitation and health teams and from project supervision, monitoring and evaluation 1.2 Feedback from community members and section leaders 1.3 Logistics records for tools and materials	(1) Achieved (2) Currently below targets (3) Achieved (4) Training on-going but ability of team members is highly variable (5) Currently underway (6) Increase has been achieved and is continuing

EMERGENCY SANITATION

Table 14.3. continued.....

Narrative summary	Measurable indicators	Means of verification	Recorded information
	<p>4. All hygiene promoters trained and able to demonstrate good understanding of key issues involved</p> <p>5. Hand-washing facilities at schools</p> <p>6. Increased coverage of appropriate family waste pits and latrines</p> <p>7. Increased cleanliness of domestic environment</p>		(7) Achieved (in general)
Activities:	<p>1. Recruitment of hygiene promoters and supervisor</p> <p>2. Training of hygiene promoters in appropriate promotional messages and methods</p> <p>3. School visits for basic hygiene education and to address problems of lack of handwashing facilities at schools</p> <p>4. Home visits to promote good hygiene practice and family garbage pits, and to explain family latrine option and give technical advice</p> <p>5. Provision of tools and cleaning materials to section leaders</p> <p>6. Checking and promoting cleanliness of communal and family latrines</p> <p>7. Monitoring use of communal and family waste pits</p>	<p>1.1 Feedback from hygiene promoters, from MSF sanitation and health teams and from project supervision, monitoring and evaluation</p> <p>1.2 Feedback from affected community through interview and discussion</p> <p>1.3 Logistics records for tools and materials</p>	<p>Most activities conducted as planned on an on-going basis; (2) training of hygiene promoters requires greater input from sanitation staff; (5) more tools and cleaning materials need to be provided to section leaders; (6-7) monitoring of communal & family latrines and waste pits needs to be more systematic</p>
Inputs:	<p>1. Tools</p> <p>2. Notebooks and pens</p> <p>3. Buckets</p> <p>4. Staff salaries</p>	<p>1.1 Logistics records for tools and materials</p> <p>1.2 Financial records</p>	<p>Adequate supply of notebooks and pens, and salary provision; orders for tools and buckets outstanding</p>

IMPLEMENTATION

Table 14.4. Checklist analysis table

Sector	Score (date)	Score (date)	Comments
Excreta disposal			
Solid waste management			
Waste management at medical centres			
Disposal of dead bodies			
Wastewater management			
Hygiene promotion			
AVERAGE site score			

14.11.4 Checklist analysis

A useful monitoring tool is to re-assess the overall sanitation situation using the rapid assessment checklists and tables (Chapter 16) at regular intervals. Table 14.4 shows a sample table in which comparable scores for each sector can be entered for different dates. A completed example is shown in the Case Study (Table C9).

This method provides a quantifiable measure of any change in service provision for each sanitation sector and the overall health of the affected population.

14.12 Evaluation

Programme evaluation is an assessment of an ongoing or completed programme, in terms of its design, implementation and outputs. This should be built on the monitoring process and aims to assess the appropriateness, effectiveness and efficiency of a programme.

14.12.1 Misunderstandings

Many aid workers become defensive if ‘their’ project is to be evaluated, since they worry that the results will be used to test them and show how poor their outputs were. This is not the purpose of evaluation. It is important that any evaluation is:

- participative; and
- constructive.

Often evaluations can be seen as simply a number-counting exercise, for example the number of latrines or tapstands provided, or the number of beneficiaries. Such evaluations provide little meaningful information.

EMERGENCY SANITATION

14.12.2 Evaluation methods

All the methods used for monitoring can be incorporated into the evaluation process. Evaluation can be conducted in a similar way to monitoring using the evaluation framework in Table 14.5 (adapted from Hallam, 1998).

Table 14.5. Evaluation framework

Evaluation component	Key factors to consider
Appropriateness	<p>Has the programme been appropriate with respect to the:</p> <ul style="list-style-type: none"> ■ perceptions and needs of the affected population; ■ policies and mandate of the agency; ■ national and international policies; and ■ urgency and prioritisation of needs.
Connectedness	<p>Have local resources and capacities been identified and built upon? Has the programme enhanced community decision-making? Has the agency an appropriate phasing-out strategy? Are the programme outputs sustainable over their design life?</p>
Effectiveness	<p>Has the programme purpose been realised? Have there been any unforeseen side effects? Has the programme evolved in line with monitoring results? Have the recommended minimum objectives been satisfied?</p>
Impact	<p>Have the programme objectives been achieved? What has been the effect of the programme on morbidity and mortality rates? How can this be determined? Has the programme contributed to the stabilisation and empowerment of the community? Have there been any unforeseen impacts?</p>
Coherence	<p>How has the agency collaborated with implementing partners? Have there been any overlaps with other humanitarian actors? Have community priorities and plans been incorporated into intervention strategies? Has there been an effective information flow between stakeholders?</p>
Coverage	<p>What has been the extent of the programme impact on the affected population? Has access to appropriate facilities been adequate? Have any groups or individuals been excluded?</p>
Efficiency	<p>Has the ratio between outputs and inputs been acceptable for:</p> <ul style="list-style-type: none"> ■ staff; ■ resources (including logistical procedures); ■ finances (cost-effectiveness); ■ time; ■ community participation; and ■ information?

IMPLEMENTATION

14.13 Report writing

An important element of monitoring and evaluation is the production of clear concise reports. These can be designed for internal use in the field and within the agency, as well as for use by external stakeholders.

14.13.1 Monitoring reports

Field reports from sanitation staff can contribute greatly to the monitoring process and ensure that information is available to other agency staff and any replacement personnel.

Weekly or monthly situation reports (sitreps) from the field can go a long way to assist programme planning, contribute to contingency planning and keep key personnel informed. Table 14.6 shows an example situation report which incorporates the key components of implementation.

There are many other formats that can be used including some of the monitoring methods mentioned.

14.13.2 Evaluation reports

Evaluations are normally conducted by individuals who have not been directly involved in programme implementation. These may include staff from agency headquarters or external consultants. Table 14.7 shows a simplified outline for an evaluation report.

EMERGENCY SANITATION

Table 14.6. Situation report example

Location	Kala camp, Zambia
Agency	Médecins Sans Frontières, Holland
Reporting period	April 2001
Name of reporter(s)	Joseph Ng'ambi; Peter Harvey
Position of reporter(s)	Watsan engineer; Researcher
Overall situation summary (security, population, climate, etc.)	Some protests concerning food rations but now generally stable situation, very few new arrivals, dry season just begun
Staff issues (new staff, contracts, salaries, etc.)	Watsan engineer due to leave within next two months, heavy workload on water supply issues; labour force stable at present
Goods received in reporting period	Bins and containers for segregation of medical waste; large aggregate for soakpits
Logistics orders outstanding (order dates)	Cleaning materials (28/4); tools (28/4)
Expenditure for reporting period	US\$1,000 (excluding salary commitments)
Financial requirements for next reporting period	Continued salary commitments only
Time constraints (reasons for delays, etc.)	Some family latrines not completed due to lack of dry grass for roofs; lack of solid waste pits due to limited supply of tools
Activities undertaken during reporting period	Sharps pit and burner constructed; new medical waste system implemented; soakpits and drainage channels completed at all waterpoints; hygiene promoters recruited; initial training of hygiene promoters undertaken
Changes made to existing plans (including reasons)	Hygiene promotion programme to run in conjunction with health home-visit programme; World Vision to maintain responsibility for solid waste at the market
Tasks outstanding / forthcoming activities	Train hygiene promoters concerning sanitation facilities, focus on solid waste and excreta disposal; placenta pit to be constructed; wastewater drainage channels to be completed
Community issues	Community representatives expressed frustration over lack of tools and cleaning materials; Market Committee currently unable to take on responsibility of paying waste workers
Information details (meetings held, data received)	Weekly meetings with community leaders; weekly meetings with Market Committee, technical manual received from WEDC
Information requested	None
Other agencies / stakeholders (news and activities)	UNHCR Watsan visit and new co-ordinator

IMPLEMENTATION

Table 14.7. Evaluation report outline**Summary**

Brief description of emergency and programme (purpose, target group, budget, period, etc.)
Purpose and approach of evaluation and summary of conclusions and recommendations

Programme justification

Justification as to why the agency decided to intervene

Activities

Brief description of programme activities, constraints and opportunities

Outputs

Summary of overall outputs achieved and lessons learnt

Resources

Description of human, financial and logistical resources used including their constraints, opportunities and lessons learnt

Evaluation framework

Completed framework to assess programme

- Appropriateness
- Connectedness
- Effectiveness
- Impact
- Coherence
- Coverage
- Efficiency

Conclusions

Conclusions in terms of overall status of programme, main findings and lessons learnt

Recommendations

Overall recommendations for continuing or similar programmes

Note: Monitoring and evaluation reports are only useful if they are READ and USED!

References and further reading

- Adams, John (1999) *Managing Water Supply and Sanitation in Emergencies*. Oxfam: Oxford.
- Davis, Jan and Lambert, Robert (1996) *Engineering in Emergencies: A practical guide for relief workers*. RedR / IT Publications: London.
- Hallam, Alistair (1998) Good Practice Review No.7: *Evaluating Humanitarian Assistance Programmes in Complex Emergencies*. Relief and Rehabilitation Network (Overseas Development Institute): London.
- Médecins Sans Frontières (1999) *Evaluation Manual: Learning from Experience*. Monitoring and Evaluation Unit, Médecins Sans Frontières: Amsterdam.
- Smout, Ian; Samson, Kevin; Coates, Sue & Snel, Marielle (2000) *Community and Management: A postgraduate distance learning module*. WEDC, Loughborough University: UK.

Chapter 15

Instructions for use

15.1 About these Guidelines

These Guidelines have been designed to help those who are involved in assessment and programme design for emergency sanitation interventions. Their overall aim is to enable fieldworkers to collect relevant information in a more structured and systematic way, and to use this to select appropriate interventions and to design and implement an effective programme. The emphasis has been on the gathering of critical information relevant to emergency sanitation as quickly and effectively as possible. This will enable the assessor to analyse the present situation as experienced by the affected population and to plan, recommend and conduct appropriate action. Specifically, the Guidelines will assist fieldworkers to:

- assess the sanitation and hygiene needs of the affected population;
- decide on the most critical sanitation and hygiene promotion interventions and implement these rapidly;
- select the most appropriate longer term sanitation and hygiene promotion interventions; and
- develop a plan for implementation.

These Guidelines are not designed to replace experience nor to make the reader a specialist in all skill areas, but to support a basic understanding.

The Manual (Chapters 1-14) is designed to act as a supporting document, which provides additional information regarding assessment, design and implementation.

The Aide Memoire that accompanies this book briefly describes the purpose of each chapter of the Guidelines and acts as a summary of the overall process of assessment and programme design. This can be used to familiarise the user with the Guidelines process or by more experienced readers.

The fieldworker will need to study these documents and preferably have training in their use prior to using them in the field. A Training Pack has been developed to support this document and may be obtained from the authors.

15.2 Approach

These guidelines cover all stages of programme design from initial situation analysis through design and implementation, to monitoring and evaluation (Figure 15.1). However, detailed designs of monitoring and evaluation systems are excluded, though suitable references are provided in the Manual. The guidelines are divided into three main stages:

- Rapid assessment and priority setting
- Programme design
- Implementation

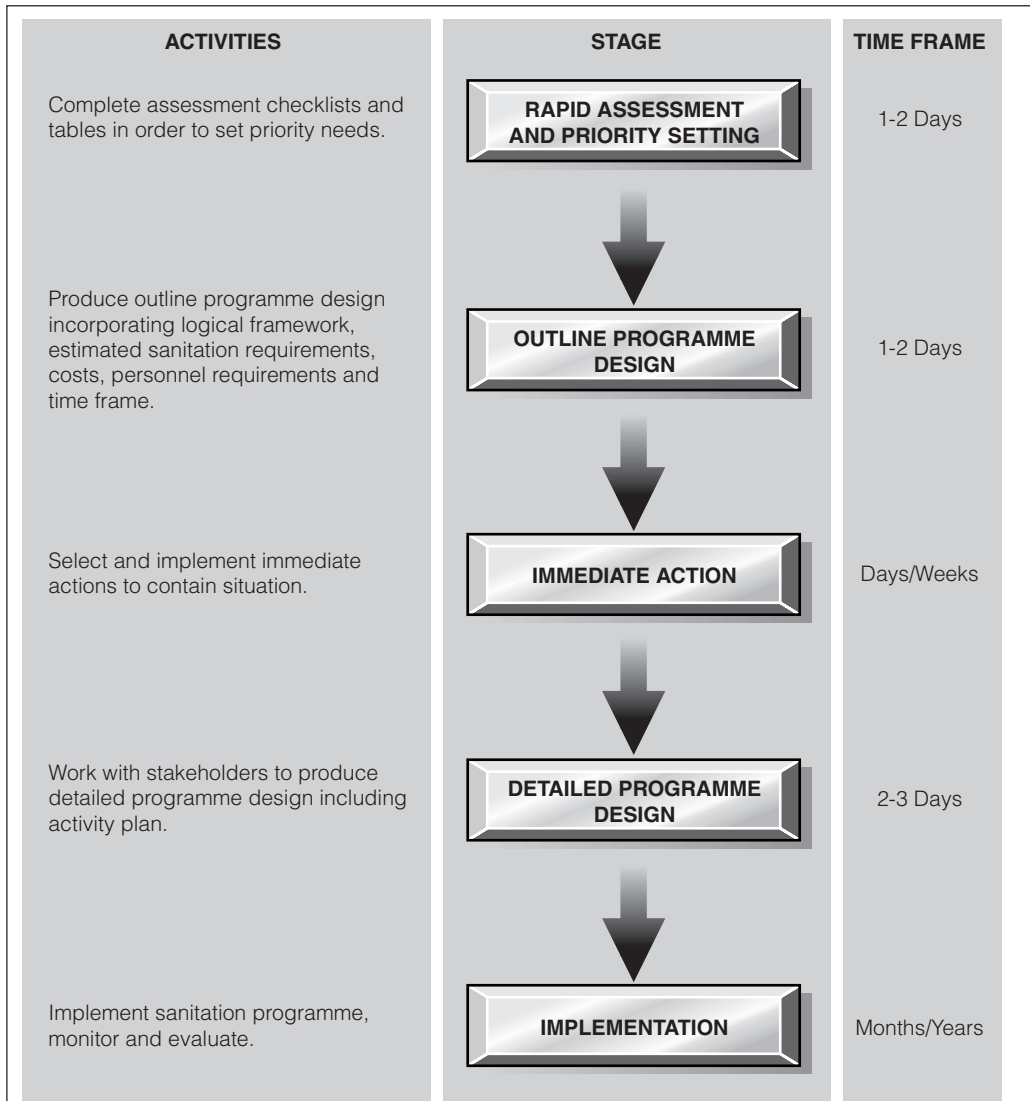

Figure 15.1. Stages in emergency sanitation programme design

15.2.1 Rapid assessment and priority setting

The need for comprehensive assessment before intervention should not be underestimated. There is often a tendency in emergencies for fieldworkers to rush straight into implementation without conducting a detailed assessment. This assessment need not be overly time consuming but it is essential that all relevant information is collected and recorded. This minimises the likelihood of inappropriate actions and wasted time and resources.

The initial assessment stage is designed to gather key relevant information rapidly and analyse it quickly in order to prioritise intervention. This approach is designed to identify the need for immediate action as well as longer term interventions.

15.2.2 Outline programme design and immediate action

Following on from the rapid assessment stage is the outline programme design stage when a rapidly produced design is outlined. This is intended for submission to the agency headquarters or donor for initial approval of the programme and budget. Should immediate action prove necessary a range of appropriate options is provided for immediate implementation as soon as the outline design has been produced.

15.2.3 Detailed programme design

Once the outline design has been approved, a stage of more detailed data collection, analysis and consultation should occur. This should adopt a more participative approach involving all affected groups in the decision-making process.

15.2.4 Implementation

Following the detailed design the implementation of the longer term emergency sanitation programme can now be conducted. This should include management, contingency planning, monitoring and evaluation.

15.3 Guideline user group

These guidelines may be useful to a range of personnel involved in emergency sanitation programmes. These could include:

- national or local government personnel from the affected country;
- field staff from local or international organisations who may have limited previous experience in this task; and
- senior staff who have significant experience in the assessment, planning and implementation process in a range of different scenarios.

It is anticipated that personnel will usually work within a team comprised of either all nationals or a mixture of national and international personnel. The areas that require investigation are multi-disciplinary and include health, social and technical issues. Use should be made of personnel from these disciplines where they are available.

15.4 Relationship between emergency sanitation and other activities

Sanitation issues are clearly broad ranging and cannot be viewed in isolation. Priority setting and the selection of appropriate actions in a sanitation programme are affected by the available water supply, local geography, local resources and community health; as well as socio-cultural expectations and practices. It is therefore important that a co-ordinated multi-disciplinary approach is adopted where possible.

It is recognised within these Guidelines, however, that the person(s) conducting the initial assessment may also be responsible for programme design and implementation, is unlikely to have specialist knowledge in all the relevant fields, and may not have the support of a large team. For this reason, additional information and relevant information sources are provided in the Manual.

15.5 Time targets

Although any effective approach to emergency sanitation requires significant attention to assessment and planning procedures, it is essential that it is possible to conduct these stages rapidly in order to begin emergency implementation.

It is anticipated that each stage may be completed within the time frames outlined in Figure 15.1. These time periods will not be possible in every situation but are general targets.

15.6 Instructions for use

Chapter 16 should be used to conduct rapid needs assessment and priority setting. The initial data collection process consists of a series of checklists designed for quick-fire quantitative and qualitative assessment for each sanitation sector. These should be completed systematically sector-by-sector.

Following this is a detailed data analysis procedure whereby the collected information should be recorded in tabular form and ‘common scores’ calculated for comparison between and prioritisation of various sanitation activities and sub-activities.

Chapter 17 provides details of the procedure to create an outline programme design. By following the stages described, a rapidly produced but suitably detailed programme proposal may be drawn up. This is designed for submission to the donor for approval.

Chapter 18 briefly describes the process used to plan and implement immediate actions directly following the outline programme design.

Chapter 19 should be used for detailed programme design, involving the stakeholders and building on the initial design produced in Chapter 16. This outlines participative approaches that can be used to gather additional socio-cultural information and to analyse it in order to select appropriate actions for programme design and implementation.

Chapter 20 should be used in implementation, monitoring and evaluation through to programme completion.

The **Case Study** demonstrates how the Guidelines have been applied in the field, with full worked examples for each section of the Guidelines.



Producing latrine slabs in Mozambique

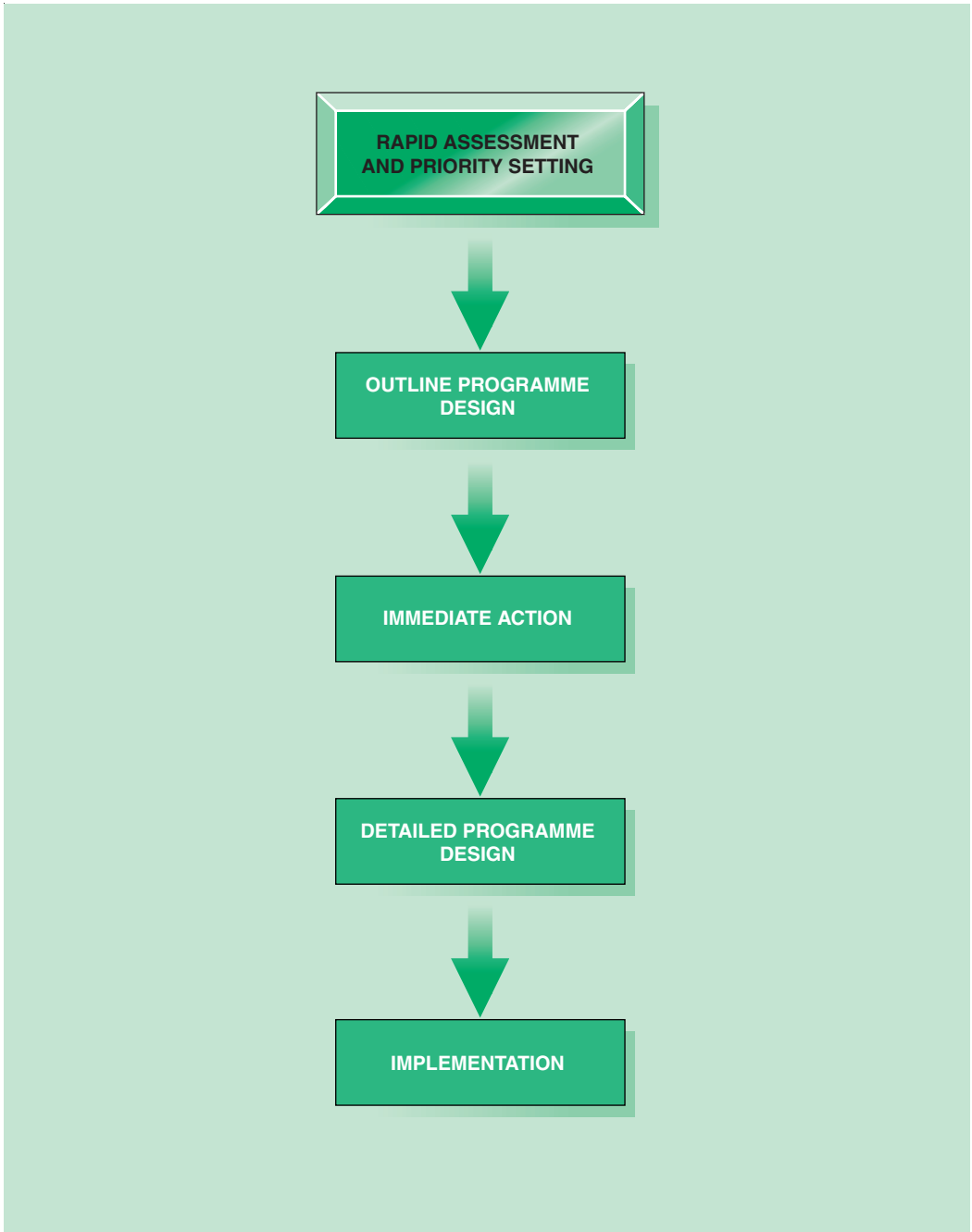

Chapter 16

Rapid assessment and priority setting

The purpose of this section is to explain how to assess the current and likely future sanitation situation and prioritise needs accordingly. It is also designed to show how to determine appropriate intervention levels and urgency of action.

16.1 Is intervention appropriate?

There are several factors which are likely to influence whether humanitarian intervention is appropriate in a given situation. The most important of these is probably the health of the affected population. The crude mortality rate and morbidity rates for sanitation-related diseases are useful indicators. Sanitation-related diseases which should be considered include:

- Diarrhoea
- Roundworm
- Bacillary dysentery (shigellosis)
- Hepatitis
- Scabies
- Hookworm
- Typhus
- Plague
- Malaria
- Dengue fever

This list is not exhaustive and advice from qualified medical staff should be sought at all times (see Chapter 2).

Wherever data is unavailable or the risk of sanitation-related disease is suspected to be high (or is completely unknown) a rapid assessment should be conducted.

16.2 Assessment process

The rapid assessment stage has been designed to facilitate the speedy collection of all relevant information and form the basis of the initial assessment. This process of data gathering will be followed by rapid analysis of the present sanitation situation. This will be

EMERGENCY SANITATION

achieved through comparison with minimum objectives for each sanitation sector. From this information the assessor will be able to prioritise needs and recommend where interventions are most important for the health and well-being of the affected community.

Both data collection and analysis must generally be undertaken quickly. Therefore the relevant checklists and tables have been designed in a comprehensive but easy to follow style. This chapter will cover the assessment process outlined in Figure 16.1.

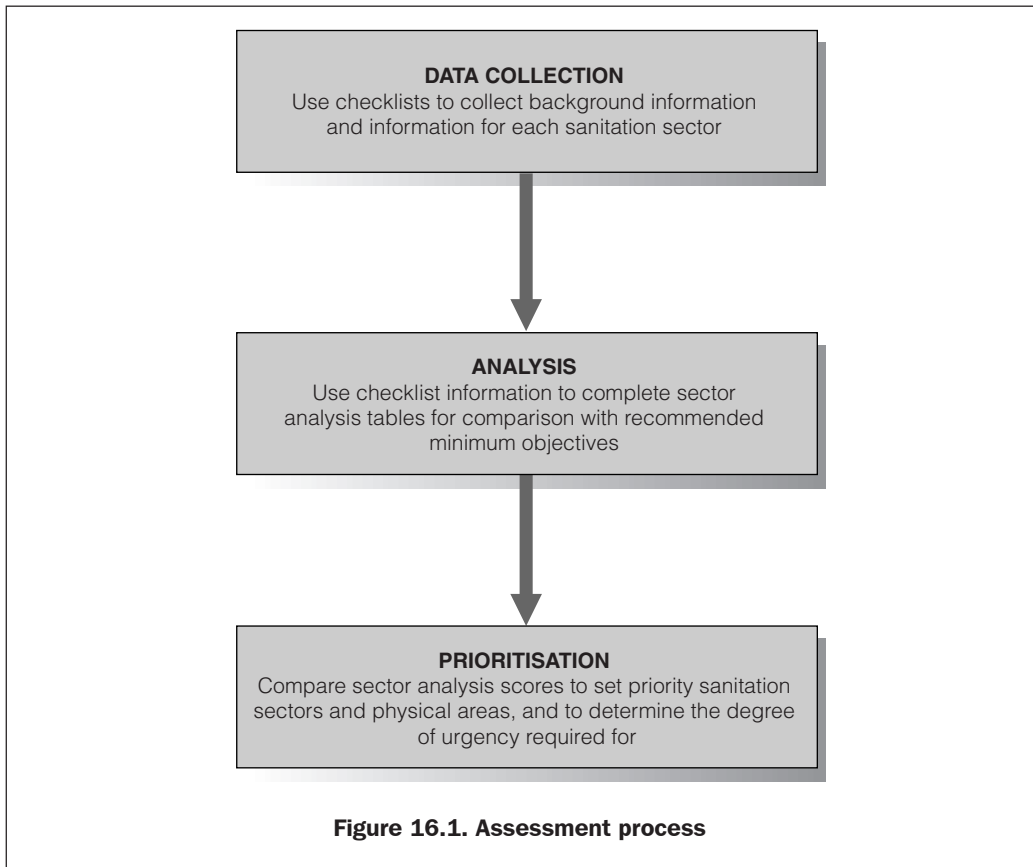

Data collection

A series of checklists is presented to assist in the collection of appropriate data. As much as possible of this data should be gathered to allow a full analysis of each sanitation sector.

Analysis

Current data for each sector is analysed to allow a comparison with recommended minimum objectives for quality, quantity and usage of facilities or practices. The ‘present situation’ refers to the existing facilities and facilities likely to be operating within one month.

Prioritisation

The result of each sector analysis will be compared with recommended intervention levels for that sector. This will enable the assessor to decide which areas should be given priority.

The prioritisation results should provide the basis for intervention. These will help the assessor to recommend necessary action according to:

- the gaps identified in one or all of the sectors; and
- the mandate of the agency.

16.3 Getting started

Some key tips that should be considered prior to data collection are outlined below.

16.3.1 Background information

Before travelling to the affected area it is possible to collect some relevant information in advance. This can be from agency headquarters, the Internet or existing publications. Reports from other organisations, and political and climatic data may be of considerable use.

16.3.2 Communication

Effective communication with all key stakeholders is likely to be essential to programme success. For this reason, on arrival at the site, one of the first steps to undertake is to locate and recruit a good interpreter. It is likely that in many cases the language of the affected population will not be widely spoken among relief staff. Even where the official language of the relevant country is a common international language, many members of that country may only be able to converse in an endemic local language. For these reasons a good interpreter is essential to ensure that all individuals are able to express their views effectively.

16.3.3 Software issues

In all programme activities it is important to maintain a good awareness of cultural, social and gender issues. A balance between technical, managerial and community-based activities should be adopted from the beginning.

16.4 Data collection

There are many methods that can be used to collect data for emergency sanitation needs assessments, but it is important to remember that no single method will provide all the data required. The best option is to use a variety of methods, as this will enable the assessor to cross-check the accuracy and reliability of the information. The following are the most common methods routinely used in the emergency sanitation sector:

- Background information and data gathering
- Questionnaires
- Interviews
- Observation
- Group discussion
- Mapping
- Measuring

It is important to appreciate the likely reliability of answers to questions. Care should be taken to refrain from asking leading questions and to involve different interest groups. More details on assessment can be found in the Manual (Chapter 3).

16.4.1 Reconnaissance

Before embarking on sector checklists it is recommended that a brief reconnaissance of the affected area be conducted. This can be done by walking and driving through the affected area and can be used to help sketch a map and gather additional background information through observation.

16.4.2 Checklists for rapid emergency sanitation assessments

The following checklists A-G have been developed to help the assessor to collect information for analysis. If there is any point or question that does not apply to your situation then assumptions or estimates may need to be made. Each sector has been divided into four sections: general description; quality; quantity; and usage.

At this stage, the data collection methods will be observation, measurement and interviews with key informants (men, women, children and representatives from the affected community), local authorities, ministries or departments responsible for sanitation, local and international agencies, and staff from medical centres in the affected area. Maps and aerial photographs may also be used where available.

An assessment checklist is provided for each of the following sectors:

- Checklist A: Background information
- Checklist B: Excreta disposal
- Checklist C: Solid waste (SW) management
- Checklist D: Waste management at medical centres
- Checklist E: Disposal of dead bodies
- Checklist F: Wastewater (WW) management
- Checklist G: Hygiene promotion

Definitions can be found in the relevant chapters (4-11) of the Manual. Checklist A can be used to collect general information which may be relevant to more than one sector.

The assessor should record the collected data in a structured way, either on paper or in the electronic form of this document. If the assessor is unsure about how to do this or how to answer any of the questions in the checklists, they should refer to the relevant section of the Manual (indicated at the top of each checklist).

If no data is available for particular aspects of assessment, estimates may need to be made based on existing information and experience. Great care should be taken in making assumptions based on similar populations or scenarios, and wherever possible accurate data should be collected for the specific situation. The physical area of assessment should include dwelling areas, medical centres, feeding centres, markets, schools and wherever there is easy access by the affected population.

Note: The term ‘facilities’ is adopted in these checklists; this can refer to existing **activities** or **practices** that are occurring in the assessment area. For example, in an area where open defecation is practised, excreta disposal may still be assessed using the checklists and tables by assessing practice rather than facilities.

Checklist A: Background information

See Chapter 4 for more information

General description

- Write a general description of the emergency, affected area and population. Include socio-political, institutional, demographic, health and geographical information.

General information

- Organisation carrying out the assessment
- Name of assessor(s)
- Position of assessor(s)
- Dates of assessment
- Maximum level of intervention (short-term or long-term)
- General location or site affected
- Logistics and resources available
- Human resources available
- Nature and history of emergency
- Government involvement
- Conflicts and likely resolutions
- Origin of affected population
- Seasonal/climatic implications
- Existing/potential donors
- Other organisations working in the area including current and planned activities

Demographic data

- Approximate number of affected people
- Breakdown of the population by sex
- Breakdown of the population by age
- Proportion of vulnerable groups (e.g. female-headed households, children, sick, disabled, etc.)
- Average family size
- Likely increase in population over next month

Geographical information

A sketch map should be produced and the following features identified and located:

- Location and types of existing sanitary facilities with estimates of key distances from dwelling areas
- Location of indiscriminate dumping of solid or medical waste
- Areas of indiscriminate excreta disposal
- Location of key public services/institutions
- Water sources
- Water storage and distribution points
- Pooling of wastewater
- Burial / cremation sites
- Groundwater levels
- Ground conditions
- Geological features
- Slope directions and drainage

Checklist B: Excreta disposal

See Chapter 6 for more information

Note: This checklist may be used to collect data for domestic or communal latrines.

General description

- Write a full description of the current facilities and practices (including anal cleansing). Include how facilities were constructed, operated and maintained with general comments on quantities, qualities and cultural factors.

Quality

- Are existing facilities technically appropriate?
- Are existing facilities socio-culturally acceptable to all users?
- What are the potential hazards for disease transmission?
 - Is there any potential contamination of food and water sources?
 - Are any excreta disposal facilities breeding sites for vectors or pests?
 - Are appropriate anal cleansing and handwashing materials available?
 - Is there evidence of any indiscriminate defecation or potential for direct human contact with excreta?
- For how long are current facilities and practices sustainable?

Quantity

- What is the ratio of domestic facilities (cubicle or space) to population?
 - If required, what is the ratio of population to facilities for children, disabled or elderly?
 - If there is a need for facilities in public places or institutions, what is the ratio of facilities to unit of measure?
- What is the maximum one-way walking distance for users?

Usage

- What proportion of the affected population has access to appropriate facilities? What groups do not have access and why?
- What proportion of the affected population is using the appropriate facilities correctly on a regular basis? Are facilities maintained hygienically?

Checklist C: Solid waste management

See Chapter 7 for more information

Note: This checklist can be used for domestic waste, feeding centres, schools or markets.

General description

- Write a full description of the current waste management system, with general comments on effectiveness, appropriateness, quantities, qualities and cultural factors.

Quality

- Are facilities and systems technically appropriate?
 - If bins or containers are provided in the affected area, are they appropriate and hygienic?
 - If required, what proportion of SW is collected and transported to a disposal site?
 - Are facilities emptied/replaced at an appropriate interval?
 - Are the vehicles that are being used appropriate for carrying SW?
 - Is the technology used for final disposal of SW appropriate?
- What are the potential hazards for disease transmission?
 - Are any of the solid waste facilities (bins, collection points, disposal sites) breeding sites for vectors and pests, and if so where?
 - What is the environmental impact (such as contamination of food and water) of solid waste management in the affected area?
 - What proportion of workers is provided with and using protective clothing?
- For how long can the current appropriate disposal systems be sustained?
 - Are the appropriate transport modes being used sustainably (available fuel, spare parts, and human resources for operation and maintenance)?

Quantity

- If the affected population disposes of their SW directly into pits, what is the ratio of pit volume per day to population?
- If bins or containers are used in the affected area, what is the ratio of waste container volume to unit of measure?
- What is the maximum walking distance to the nearest pit, bin or container?
- Where SW is transported, what is the ratio of vehicle capacity to unit of measure?
- How far is the disposal site from the nearest habitable building?
- What is the approximate volume of land available for land-fill or volume of existing pits, as a ratio to population and number of days to be used?

Usage

- What proportion of the population is using appropriate collection facilities correctly?
 - Is there evidence of indiscriminate dumping of SW in or around the affected area?
 - For areas deemed to be served by communal/family bins or pits what proportion of the population has access?
- What proportion of collected SW is transported to approved disposal sites?
- What proportion of collected SW is disposed of appropriately?

Checklist D: Waste management at medical centres*See Chapter 8 for more information***General description**

- Write a full description of the current waste management system and how it is managed, with general comments on effectiveness, appropriateness, quantities, qualities and cultural factors.

Quality

- Are the facilities and systems technically appropriate?
 - Is medical waste segregated from general waste?
 - Are the containers used for segregated waste stored and labelled correctly?
 - Are these containers kept safe, hygienic and emptied regularly?
 - Are the transport modes for segregated waste appropriate and safe?
 - Is the technology used for final disposal of medical waste safe and appropriate?
- What are the potential hazards for disease transmission?
 - Is any waste polluting water and food sources?
 - Are any of the waste facilities breeding sites for vectors and pests, and where?
 - What is the environmental impact of waste management in the area concerned?
 - Should disinfection be necessary, is it taking place correctly?
 - What proportion of staff/workers have and are wearing protective clothing whilst handling medical waste?
- How long can the current disposal system be sustained?

Quantity

- What is the average number of beds for each set of three segregated containers (sharps, medical, general)?
- What is the average walking distance to the container(s)?
- What is the volume per bed of the transport system from container to final disposal point?
- If waste is disposed into a pit, what is the ratio of original pit volume per bed?
- Is the capacity of the incinerator sufficient for its purpose?
- What is the distance to the nearest habitable building from the pit and/or incinerator?

Usage

- What proportion of waste is sorted and placed in correct containers?
- What proportion of collected waste is safely transported to the disposal point?
- What proportion of the collected waste is safely disposed of?

Checklist E: Disposal of dead bodies

See Chapter 9 for more information

General description

- Write a full description of the current facilities and systems and how they were constructed, operated and maintained with general comments on quantities, qualities and cultural factors.

Quality

- Are all facilities technically appropriate?
 - What proportion of dead bodies is buried or cremated correctly (facilities and procedures)?
 - If dead bodies require collection and transport, is it sufficient and appropriate?
 - How will seasonal variations affect access to cemetery or cremation sites?
 - What types of tools, materials and transport are available for collection and burial or cremation of dead bodies?
- What are the potential hazards for disease transmission?
 - Are any burial practices polluting food or water sources?
 - Are any of the burial practices increasing vector and pest populations?
 - What proportion of dead bodies from epidemics is disinfected before disposal?
 - What proportion of workers handling dead bodies have been provided with and are using protective clothing?
- Are current facilities socially and culturally acceptable?
 - Are the usual wake practices of the population being kept to?
 - Are the usual transportation means being used?
 - Are the usual burial/cremation practices being used?
- How long can the current facilities continue to be used?
 - Are the transport modes being used sustainable?

Quantity

- How much space (area/10000 population) is available for burial sites?
- Where appropriate, is there sufficient fuel to properly cremate all bodies?
- What is the distance to burial or cremation sites from the nearest habitable building?
- What proportion of bodies is properly disposed of in an appropriate time?

Usage

- What proportion of the affected population has access to and is willing to use the designated facilities?

Checklist F: Wastewater management

See Chapter 10 for more information

Note: These Guidelines only cover the hygienic disposal of wastewater, however, it is quite possible that problems may be due to poor water delivery and use. If this is obviously the case comment on it in the general description. This checklist may be used to assess wastewater from standposts, laundry areas, bathing areas, kitchens, medical facilities etc.

General description

- Write a full description of the current facilities and how they were constructed, operated and maintained with general comments on quantities, qualities and cultural factors.

Quality

- What proportion of facilities is technically appropriate for their current use at all times of year?
- In what way are the facilities a hazard to health or the environment? For example, are there breeding sites for flies or mosquitoes; physical hazard to users from sharp edges or slippery surfaces; pollution of water courses; or strong odour close to dwellings, etc.
- What proportion of facilities is adequately maintained and managed?

Quantity

- What proportion of facilities have been provided with a functional wastewater disposal system?

Usage

- What proportion of the total wastewater generated is disposed of in appropriate designated locations?

Checklist G: Hygiene promotion

See Chapter 11 for more information

Note: Hygiene promotion covers good practice for use and maintenance only. Promotion to install new facilities or manage systems is covered by the checklist for that sector.

The following sectors are considered for hygiene promotion in these Guidelines:

Domestic excreta disposal
 Communal excreta disposal
 Domestic solid waste disposal (consumer actions only);
 Solid waste disposal at communal sites (at point of waste generation only)
 Medical waste disposal
 Disposal of dead bodies
 Wastewater disposal systems

Best practice assumes that any hygiene promotion programme will cover all these sectors.

General description

- Write a full description of the current hygiene promotion programme noting its objectives and strategy. Assess its strengths and weaknesses, successes and failures.

Quality

- What proportion of facilitators is from the same social and ethnic background as the affected population?
- What proportion of the facilitators has received appropriate training?
- What proportion of the messages being promoted is accurate, appropriate to the target audiences and completely covers the topic?
 - Are vulnerable and gender groups (disabled, women, children, men etc.) targeted by hygiene promotion activities?
- What proportion of the methods being used to disseminate the messages is compatible with socio-cultural aspects of the population?

Quantity

- What is number of facilitators per thousand affected people?
- What proportion of the affected area has been targeted for hygiene promotion activities?
- What proportion of relevant sanitation sectors covered by these Guidelines is being targeted by the promotion programme?

Usage

- What proportion of the affected population has received, understood and remembered the messages?
- What proportion of the population has put hygiene promotion messages into practice?
- What proportion of all messages delivered has been implemented by the population?

16.5 Data analysis

Once as much as possible of the data in section 16.3 has been collected, or estimated, work can begin on its analysis. The purpose of this analysis is to obtain a clear picture of the current situation and provide the data necessary to prioritise interventions. The analysis process for all types of sanitation intervention should follow the procedure outlined below:

- For each of the following tables fill in the column entitled ‘**Collected data**’ using relevant information collected in section 16.3. This information should be only several words briefly summarising the data collected. In the early stages of an emergency some of the data may have to be estimated and assumptions made because of lack of information or time, but the process can always be repeated at a later stage.
- Compare the collected data with the values in the ‘**Range**’ columns to assign a score. Definitions for terms used are provided in the Manual (Chapter 5). Select a number between 1 and 10 that best reflects the collected data (1 being better than long-term standards and 10 being worse than minimum standards). The assessor should be able to interpret the data and use the recommended scoring system as a guideline. This number is the **Base score** (‘**B**’).

N.B. Where table rows are shaded grey only **one** row should be completed for each analysis table. This allows separate analysis of the relevant sanitation situation for different locations or services, e.g. health centres, schools, markets, feeding centres etc.

- Where indicated, multiply the base score number by that shown in the **Multiplier** (‘**M**’) column. This weights the score so that *quality, quantity and usage* have equal importance in the analysis. Write the resultant number in the **Common score** (‘**C**’) column.
- Add up the numbers in the ‘**C**’ column and place the answer in the ‘**TOTAL**’ box provided at the bottom of the table. In Table A.1 only the *average* should be used, not the total.
- The total scores will be used for comparison and prioritisation between various sanitation sectors and between different physical areas assessed.

16.5.1 Recommended objectives

The recommended objectives used in the range columns are based on the Sphere Project *Minimum Standards in Water Supply and Sanitation*. These provide a description of what people affected by disasters have a right to expect from humanitarian assistance and specify the minimum acceptable levels of service (Sphere Project, 1999). These have been expanded to incorporate the following elements:

- **Quality:** technical appropriateness; social and cultural acceptability; potential health hazard; and sustainability.
- **Quantity:** number of facilities/activities; capacity; and distances to facilities.
- **Usage:** accessibility; and operation and maintenance

RAPID ASSESSMENT AND PRIORITY SETTING

In addition, objectives have been divided into the following intervention levels based on duration of service:

- **Immediate:** very basic minimum standards applied to the initial phase of an emergency lasting up to one month's duration
- **Short-term:** basic minimum standards applied to emergency situations lasting up to six months' duration
- **Long-term:** objectives applied to longer term emergency scenarios and interventions lasting up to several years' duration

Detailed recommended minimum objectives and definitions of terms are provided in the Manual (Chapter 5).

	<i>Description</i>
1	Better than long-term objectives
2	Equivalent to long-term objectives
3	Between short-term and long-term objectives
4	Equivalent to short-term objectives
5-6	Between immediate and short-term objectives
7	Equivalent to immediate objectives
8-9	Worse than immediate objectives
10	Much worse than immediate objectives

B. Excreta disposal

B.1-3 Domestic excreta disposal

Location of assessment: Date: Assessor:
 This table should be completed for each of the following as appropriate (underline or circle the relevant):
B.1 Single or shared family latrines B.2 Domestic communal latrines B.3 Latrines for special groups

Data	Collected data	B	Range			M	C
			10	7	4		
Technical appropriateness			inappropriate	technically basic	appropriate	very appropriate	0.25
Social and cultural acceptability			very unacceptable	unacceptable	acceptable	very acceptable	0.25
Potential hazard to health			major hazard	basic protection	minimal hazard	no hazard	0.25
Sustainability of facilities			None	1 month	6 months	>1 year	0.25
Ratio of latrine spaces to population			None	1/100 or immediate responses	1/50	1/20	0.5
Maximum one-way walking distance			>100m	75m	50m	<25m	0.5
% of population with access to appropriate facilities			None	50%	75%	>95%	0.5
% of population using appropriate facilities correctly			None	50%	75%	>95%	0.5
Total							

B.4 Excreta disposal for public places

Location of assessment:..... Date:..... Assessor:.....
 This table should be completed for each of the following as appropriate (underline or circle the relevant):
 Medical centres Schools Markets Feeding centres

Data	Collected data	B	Range			M	C
			10	7	4		
Technical appropriateness			inappropriate	technically basic	appropriate	very appropriate	0.25
Social and cultural acceptability			very unacceptable	unacceptable	acceptable	very acceptable	0.25
Potential hazard to health			major hazard	basic protection	minimal hazard	no hazard	0.25
Sustainability of facilities			None	1 month	6 months	> 1 year	0.25
Ratio of latrine spaces to health centre beds / patients OR			None	1/50 beds 1/100 outpatients	1/20 beds 1/50 outpatients	1/10 beds 1/20 outpatients	0.5 OR
Ratio of latrine spaces to school pupils OR			None	1/50 girls 1/100 boys	1/30 girls 1/60 boys	1/15 girls 1/30 boys	0.5 OR
Ratio of latrine spaces to market stalls OR			None	1/100 stalls	1/50 stalls	1/20 stalls	0.5 OR
Ratio of latrine spaces to population at feeding centres			None	1/100	1/50	1/20	0.5

continued

EMERGENCY SANITATION

B.2 Excreta disposal for public places

... continued

Data	Collected data	B	Range				M	C
			10	7	4	1		
Maximum one-way walking distance			>100m	75m	50m	<25m	0.5	
% of population with access to appropriate facilities			None	50%	75%	>95%	0.5	
% of population using appropriate facilities correctly			None	50%	75%	>95%	0.5	
Total								

C. Solid waste management
C.1 Family or communal pit disposal (on-site)

Location of assessment:.....Date:.....Assessor:.....
 This table should be completed for each of the following as appropriate (underline or circle the relevant):

Domestic/dwelling areas Markets Feeding centres Schools

Data	Collected data	B	Range				M	C
			10	7	4	1		
Technical appropriateness			inappropriate	Technically basic	appropriate	very appropriate	0.33	
Potential hazard to health			major hazard	Basic protection	minimal hazard	no hazard	0.33	
Sustainability of facilities			None	1 month	6 months	>1 year	0.33	
Ratio of pit volume to population			None	6m ³ /200	6m ³ /100	6m ³ /50	0.5	
Maximum one-way walking distance to family pit OR			> 70m	45m	30m	15m	0.5 OR	
Maximum one-way walking distance to communal pit			>250m	200m	150m	100m	0.5	
% of population with access to appropriate facilities			None	50%	75%	>95%	0.5	
% of population using appropriate facilities correctly			None	50%	75%	>95%	0.5	
							Total	

C.2 Bin collection and disposal (off-site)

Location of assessment:..... Date:..... Assessor:.....

This table should be completed for each of the following as appropriate (underline or circle the relevant):
Medical centres Schools Markets Feeding centres

Data	Collected data	B	Range			M	C
			10	7	4		
Technical appropriateness			Inappropriate	technically basic	appropriate	very appropriate	0.33
Potential health hazard			major hazard	basic protection	minimal hazard	no hazard	0.33
Sustainability of facilities			None	1 month	6 months	>1 year	0.33
Ratio of bin volume to population (domestic, school or feeding centre) OR			None	0.5/ person	1.0/ person	2.0/ person	0.2 OR
Ratio of bin volume to markets stalls			None	2.5/ stall	5.0/ stall	10.0/ stall	0.2
Maximum one way walking distance to the nearest bin			> 70m	45m	30m	15m	0.2
Ratio of collection vehicle volume (per day) to unit of measure			None	0.2/ person or 5/ stall	0.4/ person or 10/ stall	1.0/ person or 20/ stall	0.2

continued ...

RAPID ASSESSMENT AND PRIORITY SETTING

C.2 Bin collection and disposal (off-site)

.... continued

Data	Collected data	B	Range				M	C
			10	7	4	1		
Distance to final disposal site from nearest habitable building			< 250m	500m	750m	>1km	0.2	
Land available for land filling per day OR			None	0.25m ³ /person	0.50m ³ /person	0.75m ³ /person	0.2 OR	
Ratio of pit volume to population			None	6m ³ /200	6m ³ /100	6m ³ /50	0.2	
% of population using appropriate collection facilities correctly			None	50%	75%	>95%	0.33	
% of collected solid waste transported correctly			None	50%	75%	>95%	0.33	
% of collected solid waste disposed of correctly			None	50%	75%	>95%	0.33	
							Total	

C.3 Communal waste collection (without bins) and disposal (off-site)

Location of assessment:.....Date:.....Assessor:.....

This table should be completed for each of the following as appropriate (underline or circle the relevant):

Markets Feeding centres Schools

Data	Collected data	B	Range				M	C
			10	7	4	1		
Technical appropriateness			inappropriate	technically basic	appropriate	very appropriate	0.33	
Potential health hazard			major hazard	basic protection	minimal hazard	no hazard	0.33	
Sustainability of facilities			None	1 month	6 months	> 1 year	0.33	
Ratio of collection vehicle volume to unit of measure			None	0.2/ person or 5/stall	0.4/ person or 10/stall	1.0/ person or 20/stall	0.33	
Distance to final disposal site from nearest habitable building			<250m	500m	750m	> 1km	0.33	
Land available for land filling per day OR			None	0.25m ³ /person	0.50m ³ /person	0.75m ³ /person	0.33 OR	
Ratio of pit volume (per day) to population			None	6m ³ /200	6m ³ /100	6m ³ /50	0.33	

continued

C.3 Communal waste collection (without bins) and disposal (off-site)

..... continued

Data	Collected data	B	Range				M	C
			10	7	4	1		
% of population using appropriate collection facilities correctly			None	50%	75%	>95%	0.33	
% of collected solid waste transported correctly			None	50%	75%	>95%	0.33	
% of collected solid waste disposed of correctly			None	50%	75%	>95%	0.33	
Total								

EMERGENCY SANITATION

D. Waste management at medical centres

Location of assessment: Date: Assessor:

Data	Collected data	B	Range 10	7			4			1			M	C
Technical appropriateness			inappropriate	technically basic	appropriate	very appropriate	0.33							
Potential health hazard			major hazard	basic protection	minimal hazard	no hazard	0.33							
Sustainability of facilities			None	1 month	6 months	>1 year	0.33							
No. of beds* per set of segregated containers			None	40 beds/ 1 set	30 beds/ 1 set	20 beds/ 1 set	0.2							
Average one- way distance to containers			>20m	20m	10m	<5m	0.2							
Volume of transport for segregated waste			None	Insufficient	Sufficient	Ideal	0.2							
Original pit volume per bed* AND/OR			None	400/bed	800/bed	>1200/bed	0.2/ 0.1							
Capacity of incinerator			Very insufficient	Insufficient	Sufficient	Ideal	0.2/ 0.1							
Distance of incinerator from nearest habitable building AND/OR			0m	5m	15m	>30m	0.2/ 0.1							

continued

D. Waste management at medical centres

.... continued

Data	Collected data	B	Range				M	C
			10	7	4	1		
Distance of pit from nearest habitable building			<25m	50m	75m	>100m	0.2/ 0.1	
% of waste appropriately collected and sorted			None	50%	75%	>95%	0.33	
% of collected waste safely transported			None	50%	75%	>95%	0.33	
% of collected waste safely disposed			None	50%	75%	>95%	0.33	
Total								

*Where medical centres have no beds, 2 outpatients can be taken to be equivalent to 1 bed.

EMERGENCY SANITATION

E. Disposal of dead bodies

Location of assessment:..... Date:..... Assessor:.....

This table should be completed for each of the following as appropriate (underline or circle the relevant):

E.1 Burial E.2 Cremation at Domestic/dwelling areas or Medical centres

Data	Collected data	B	Range				M	C
			10	7	4	1		
Technical appropriateness			inappropriate	technically basic	appropriate	very appropriate	0.25	
Social and cultural acceptability			very unacceptable	unacceptable	acceptable	very acceptable	0.25	
Potential health hazard			major hazard	basic protection	minimal hazard	no hazard	0.25	
Sustainability of facilities			None	1 month	6 months	> 1 year	0.25	
Sites available for burial OR			None	500m ² / 10,000	1000m ² /10,000	1500m ² /10,000	0.330R	
Availability of fuel for cremation			None	basic supply	adequate	plentiful	0.33	
One-way distance to burial/ cremation sites from nearest habitable building			<100m	100m	300m	500m	0.33	
Collection and storage of dead bodies before decomposition			None	50%	75%	100%	0.33	
% of population with access and willing to use designated facilities			None	50%	75%	>95%	1.0	
Total								

F. Wastewater management

Location of assessment:..... Date:..... Assessor:.....

This table should be completed for each of the following as appropriate (underline or circle the relevant):

Domestic/dwelling areas Markets Feeding centres Medical centres Schools

Data	Collected data	B	Range				M	C
			10	7	4	1		
% of facilities technically appropriate to current purpose		None	50%	75%	100%	0.33		
Potential health hazard		major hazard	basic protection	minimal hazard	no hazard	0.33		
% of wastewater facilities which are adequately maintained and managed		None	50%	75%	100%	0.33		
% of facilities with functional wastewater disposal systems		None	50%	75%	100%	1.0		
% of wastewater disposed of in appropriate designated sites		None	50%	75%	>95%	1.0		
Total								

G. Hygiene promotion

Location of assessment: Date: Assessor:
 This table should be completed for each of the following as appropriate (underline or circle the relevant):

Domestic/dwelling areas Markets Feeding centres Medical centres Schools

Data	Collected data	B	Range				M	C
			10	7	4	1		
% of trained facilitators from the same social background			None	50%	75%	100%	0.33	
% of messages accurate, appropriate and complete			None	50%	75%	100%	0.33	
% of messages delivered in a way that is socio-culturally acceptable			None	50%	75%	100%	0.33	
Number of facilitators per thousand people			None	1	2	>2	0.33	
% area covered by campaign			None	50%	75%	100%	0.33	
% of relevant sanitation sectors for which appropriate use is promoted			None	50%	75%	100%	0.33	

continued

G. Hygiene promotion

.... continued

Data	Collected data	B	Range				M	C
			10	7	4	1		
% of population receiving, understanding and remembering promotional messages			None	30%	50%	> 75%	0.33	
% of population putting messages into practice			None	30%	50%	> 75%	0.33	
% of messages delivered implemented			None	30%	50%	> 75%	0.33	
							Total	

16.6 Interpretation of results

16.6.1 Sector results

The 'TOTAL' scores from each completed sector table (B-G) should then be entered in Table 16.2. The sector letters indicate which table results should be entered in each row. These can be recorded for each applicable area, in the columns provided. Where no score is available or sectors are not relevant table boxes should remain blank.

The average value for each row should then be calculated and used to determine the sector average as appropriate. The average value for each column should also be calculated to determine the area average.

From this, the overall situation for each sanitation sector and each physical area can be assessed.

Refer to the Case Study for examples of how these tables can be completed.

RAPID ASSESSMENT AND PRIORITY SETTING

Table 16.2. Sector analysis results								
Location of assessment:..... Date:..... Assessor:.....								
Sector	Area					Average	Sector average	Priority sector(s)
	D A	Mkt	F C	M C	Sch			
B. Excreta disposal								
B.1 Single/shared								
B.2 Domestic communal								
B.3 Special groups								
B.4 Communal latrines								
C. Solid waste management								
C.1 Pit disposal								
C.2 Bin disposal								
C.3 Communal disposal								
D. Waste management at medical centres								
D.								
E. Disposal of dead bodies								
E.1 Burial								
E.2 Cremation								
F. Wastewater management								
F.								
G. Hygiene promotion								
G.								
Area average							Site average	
Priority area(s)								

D A – Dwelling areas; Mkt – Markets; F C – Feeding centres; M C – Medical centres; Sch - Schools

EMERGENCY SANITATION

The final assessment results can be displayed more simply in a summary table.

Table 16.3. Assessment summary		
Sector	Score	Priority
Excreta disposal		
Solid waste management		
Waste management at medical centres		
Disposal of dead bodies		
Wastewater management		
Hygiene promotion		
AVERAGE site score		

Each score in Table 16.3 can be compared to the ranges in Table 16.4 below:

Table 16.4. Intervention levels			
Score	Level	Situation	Priority
24 – 30	Unacceptable	The recommended minimum immediate objectives have not been achieved and immediate action is needed.	Very high
17 – 24	Immediate acceptable level	Recommended minimum immediate objectives or better are in place but action is needed to achieve the short-term objectives.	High
10 – 17	Short-term acceptable level	Recommended minimum short-term objectives or better are in place but action is needed to achieve the long-term objectives.	Medium
3 – 10	Long-term acceptable level	Recommended minimum long-term objectives or better are in place and no immediate actions are needed.	Low

16.6.2 Priority setting process

The assessment scores obtained can be used to compare sanitation sectors and areas, and to set priorities between them. Figure 16.2 outlines the process:

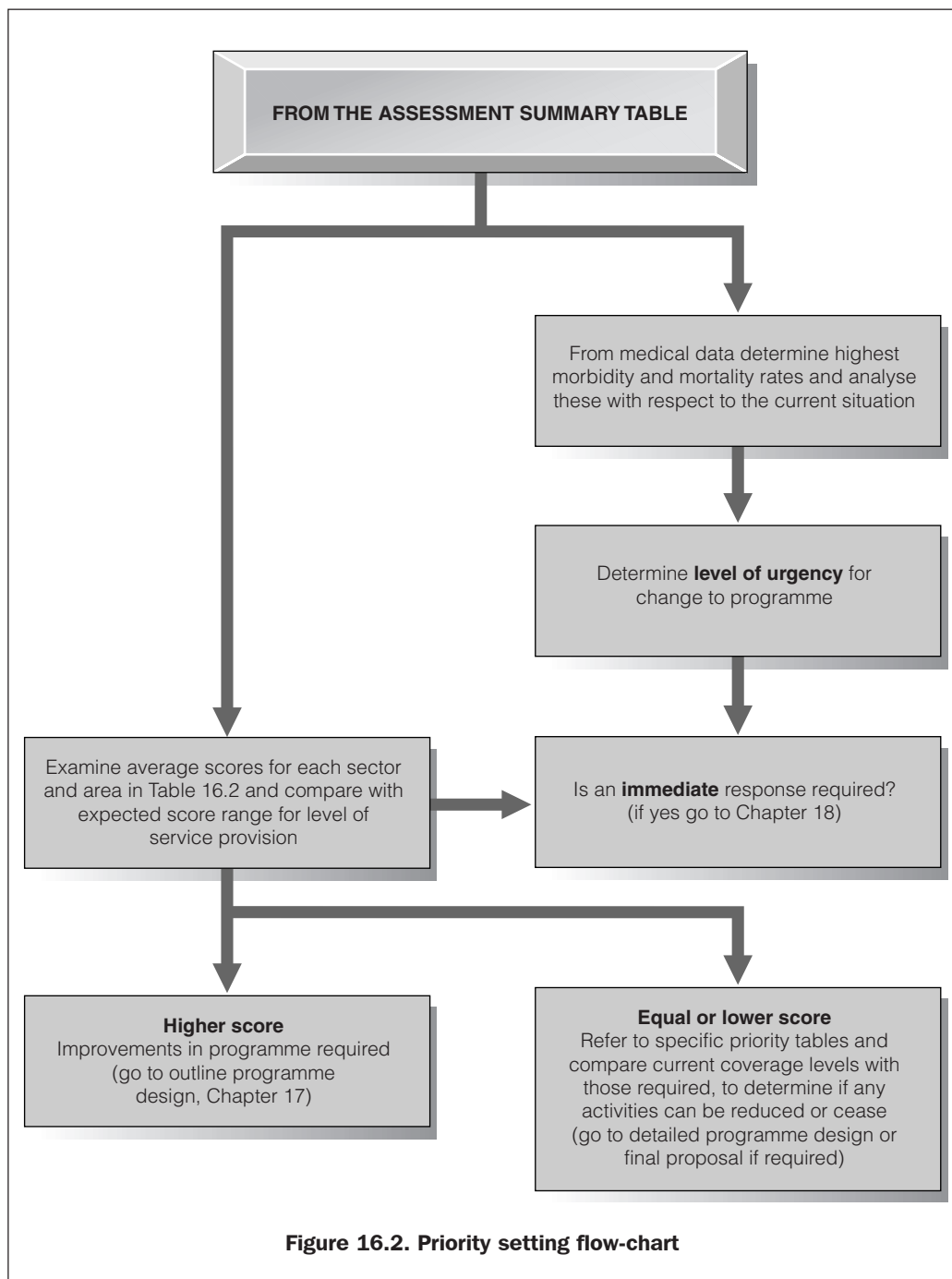

Figure 16.2. Priority setting flow-chart

EMERGENCY SANITATION

In deciding on the appropriate priority level it is important to take into account the current situation, for example whether it is a new emergency or a long-term programme, and the mandate of the agency. The appropriate intervention level aimed for is an important factor in determining priorities. For example, if only short-term intervention is required then the scores obtained need only be compared to the short-term acceptable level.

The highest priority is the sector/area for which the score is highest. However, action need only be taken if this score is above the appropriate intervention level score. Priorities may be considered in terms of sector or physical area or both.

16.6.3 Recommendations

Based on this analysis the assessor will be able to make one of the following recommendations for each sanitation sector, area or sub-sector:

- No action is required.
- Action is required but it does not fall within the mandate of the agency.
- Immediate action is required in specific sectors and sub-sectors to ensure minimum levels of service.
- Action is required in specific sectors and sub-sectors to ensure that short-term levels of service are in place.
- Action is required in specific sectors and sub-sectors to ensure that long-term levels of service are in place.

Table 16.5 suggests the levels of intervention appropriate for different common scenarios.

Table 16.5. Recommended intervention levels and scenarios				
Scenarios and recommended interventions	<i>The affected population stay in the affected area immediately after a disaster</i>	<i>The affected population go through a transit camp immediately after a disaster</i>	<i>The affected population remain in a temporary location for up to six months</i>	<i>The affected population move to a new area and are likely to remain there for more than a year</i>
Immediate action	X	X	X	X
Short-term measure		X	X	
Long-term measure	X			X



Children collecting water, Zambia

EMERGENCY SANITATION

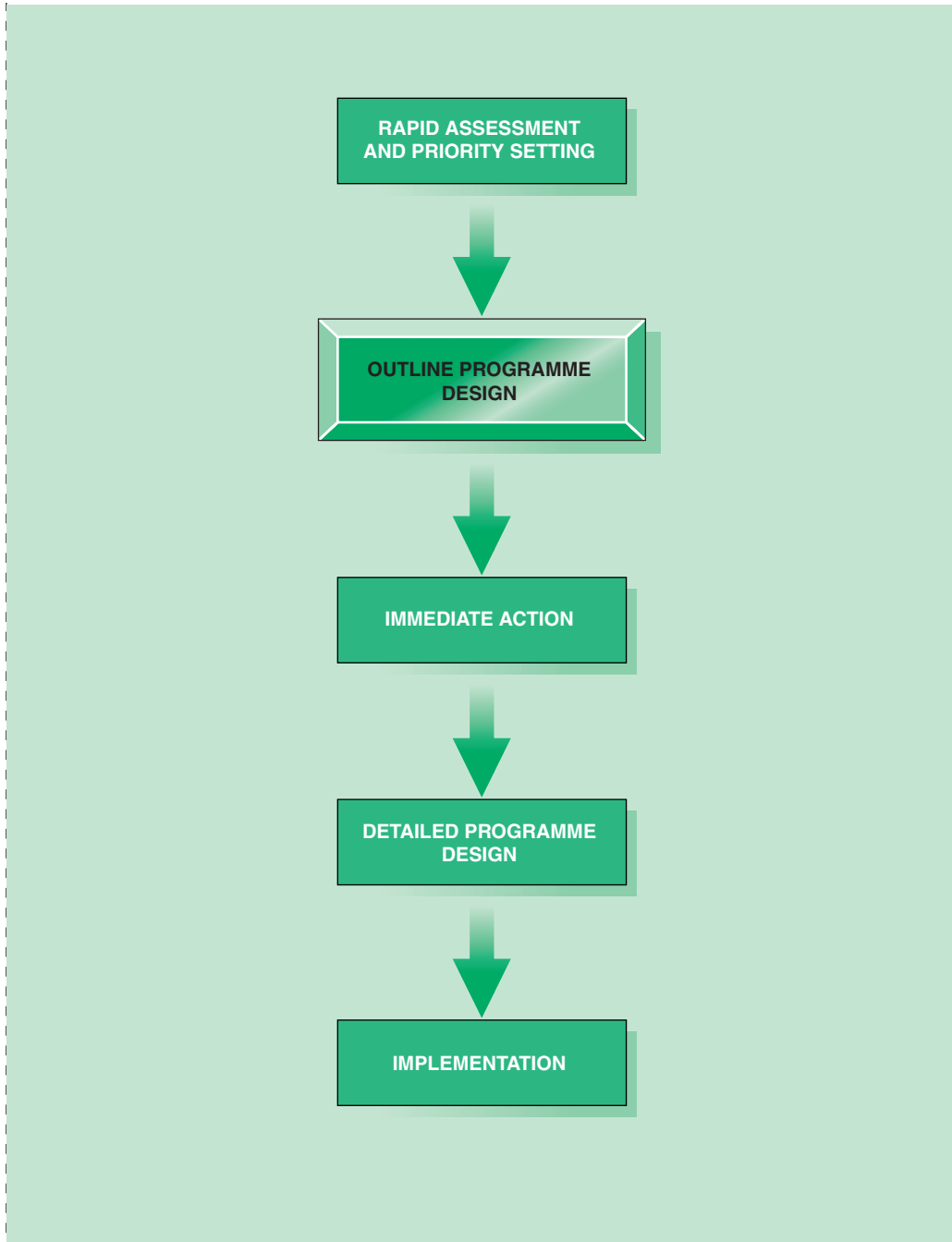

Chapter 17

Outline programme design

The outline programme design is a rapidly produced plan of action for the selected sanitation sectors. This is developed by key agency staff and involves minimal consultation with the affected population. General solutions only are considered at this stage.

17.1 Design process

The following flow-chart (Figure 17.1) summarises the outline programme design process:

EMERGENCY SANITATION

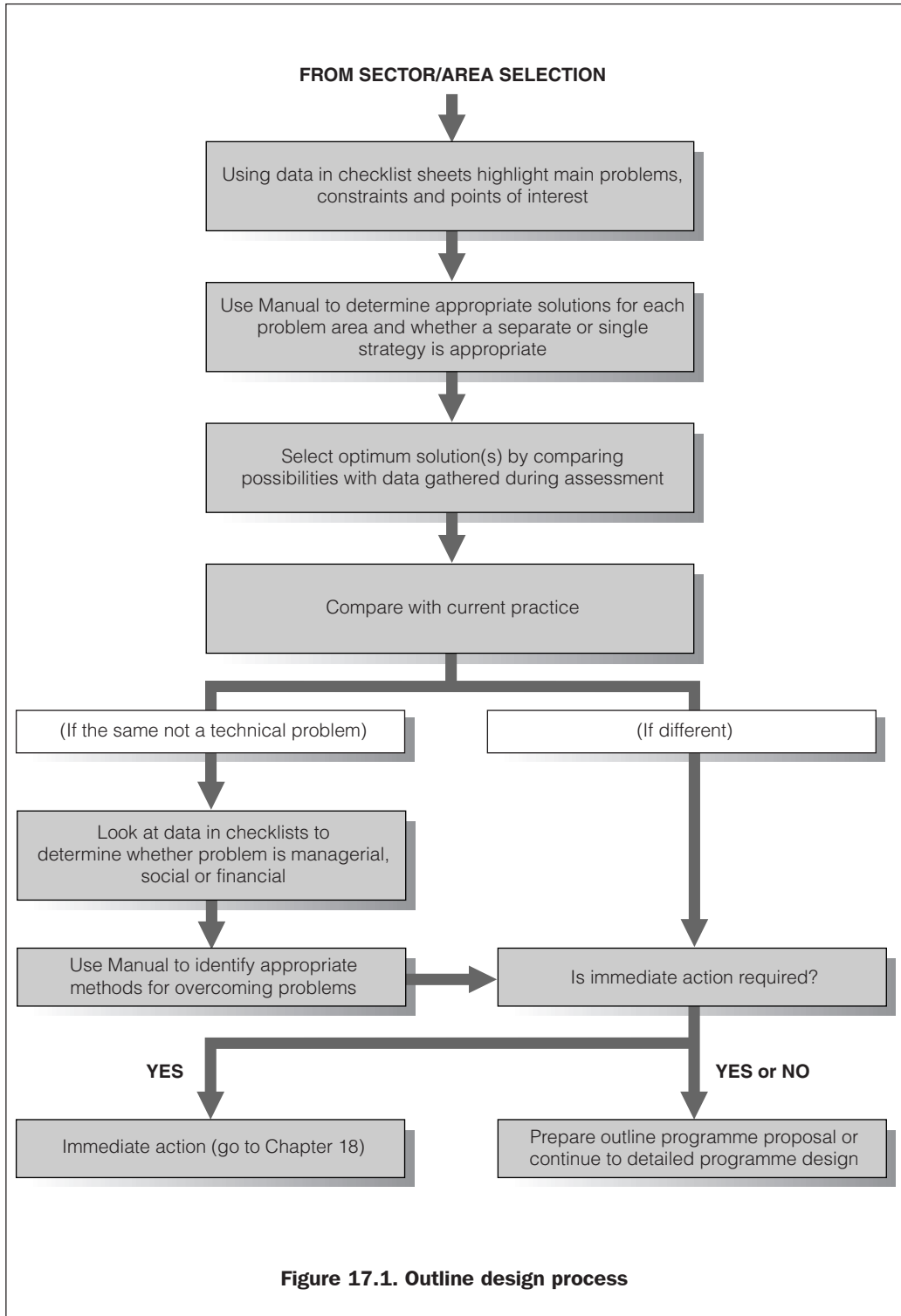

17.2 Problems, constraints and points of interest

The first stage in the outline programme design is to return to the checklists for the selected sanitation sectors and areas and examine the problems, constraints and points of interest noted. The importance of the general description will be clearly seen here, since the more detail recorded, the easier and more effective this exercise.

Current problems identified may concern quality, quantity or usage of facilities or practices. They may also be technical, social, managerial or financial in nature.

Constraints are factors which may limit the solutions available. These may be physical constraints such as space, groundwater levels, soil permeability, and availability of materials, or organisational constraints such as finance, transport and human resources.

Points of interest may be factors specific to the current scenario that are likely to influence the selection of appropriate solutions.

17.3 Solution selection

In order to select appropriate solutions to the problems identified above, refer to the relevant section of Manual (Chapters 6-11). These chapters have brief descriptions of the options available, with notes on advantages and associated constraints. In addition, tables can be used for some sectors to determine appropriate options for different scenarios.

The optimum solution should be selected through comparison with the data gathered during assessment. A single solution may be decided upon or a combination of solutions adopted.

At this stage general solutions should be selected only. It is not necessary to include details of implementation or management, but the outline design should contain a rough idea of what facilities or systems are to be provided. Solutions should be flexible and open to change as a result of consultation during detailed programme design or changes in the situation. This fact should be made clear to the donor in any outline proposal.

17.4 Comparison with current practice

Once a potential solution has been decided upon this should be compared with what is actually occurring at the current time. If the selected option is different to current practice then the problem is of a technical nature and can be overcome by its implementation. Where immediate action is required, implementation should take place immediately according to the process outlined in Chapter 18. In addition, the outline programme proposal should be produced if required, and the detailed programme design process can begin (Chapter 19).

If the selected option is the same as current practice this indicates that the problem is not a technical one but it may be social, managerial or financial. In order to determine which, examine the information recorded in the relevant checklist.

The Manual can be used to identify methods for overcoming non-technical problems.

Table 17.1. Structure of outline programme proposal

Background information Brief description of emergency including history, causes and effects (climatic, political, etc.)
Programme justification Justification as to why humanitarian intervention is required
Proposed intervention programme Brief description of programme objectives, proposed activities and potential opportunities
Draft Gantt chart Draft timetable for implementation indicating key actions
Estimated personnel requirement Summary of likely personnel required including job titles and responsibilities
Estimated budget Summary of likely costs for each sanitation sector
Draft logical framework Simplified logical framework outlining programme purpose and intended outputs

17.5 Outline programme proposal

At this stage the programme design is only an initial draft and is likely to be developed exclusively by agency staff. Depending upon the requirements of the agency it may be necessary to write an outline proposal based on this design. The aim of the outline proposal is to ensure that funds are available before in-depth consultation with the affected community, and thereby avoid raising community expectations unnecessarily. It also helps to speed up the funding process and it allows agencies to make affective plans for appropriate resources (especially staff). An appropriate budget should consist of estimated unit costs, where each unit represents a complete facility. The outline programme proposal should be produced rapidly and incorporate the information indicated in Table 17.1.

The detailed design (Chapter 19) will be developed through interactive and consultative approaches involving the key stakeholders in the decision-making process.

17.6 Approval of programme and budget

Following the production of an outline programme proposal it must be submitted to the agency headquarters or donor for approval.

It should not be assumed that the donor will accept the proposed programme immediately. It may be necessary to modify the budget, in which case each sanitation sector budget line should be adjusted according to the prioritisation results.

Any amendment should be reflected in all programme aspects (quality, quantity and usage) for each particular sector. As soon as a programme has been approved the agency should begin implementation and appropriate resources and staff should be mobilised.



Temporary shelter, Zambia

EMERGENCY SANITATION

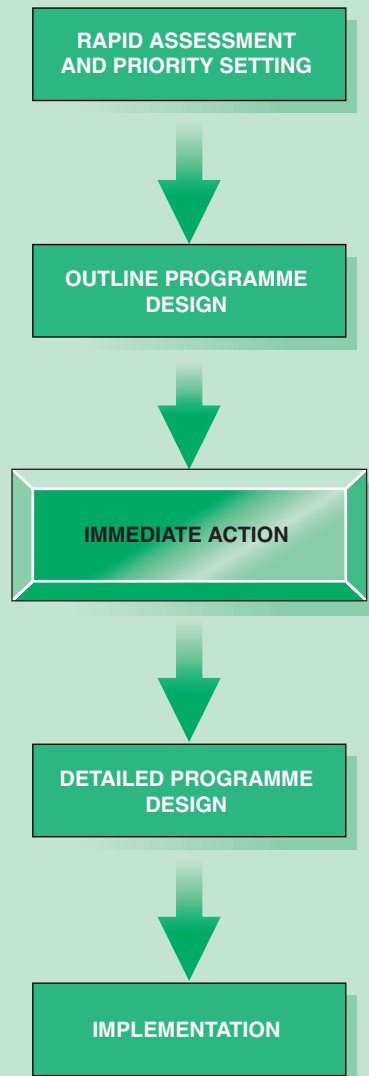

Chapter 18

Immediate action

Immediate action refers to intervention that must take place immediately in order to respond to an emergency and lead to stabilisation. This usually occurs directly after the impact phase of an emergency (period of cyclone, onset of genocide, etc.) but can occur at any point in a programme as the situation changes (cholera outbreak, etc.). This is often the most crucial stage of any emergency intervention programme where the most excess mortality occurs and where rapid and effective action can have the most impact on the health and well-being of the affected population.

18.1 Objective of immediate action

Immediate action is designed to meet existing and imminent urgent sanitation needs. It should involve relatively simple emergency interventions that can be implemented rapidly. The emphasis should be on preventing the spread of disease through the provision of basic services and amenities.

It is likely that the rapid assessment and priority-setting stage will identify the need for the immediate provision of some basic facilities or activities in order to contain excreta, solid waste, medical waste and wastewater at source, and minimise the spread of disease in the affected area. Assuming that the agency has the capacity to do this, it will allow them to act whilst they or other agencies design an appropriate longer term programme.

The overall aim of immediate action can be summarised as follows:

Immediate actions are designed to contain and localise excreta, solid waste, medical waste, dead bodies and wastewater, and promote best hygiene practice in order to create a safer environment and minimise the spread of disease in the affected area.

18.2 Action selection process

Figure 18.1 summarises the process used to select appropriate immediate actions. Although it is essential that actions have the maximum beneficial impact and that they can be imple-

EMERGENCY SANITATION

mented rapidly, it is also important that they do not conflict with or complicate long-term needs and plans.

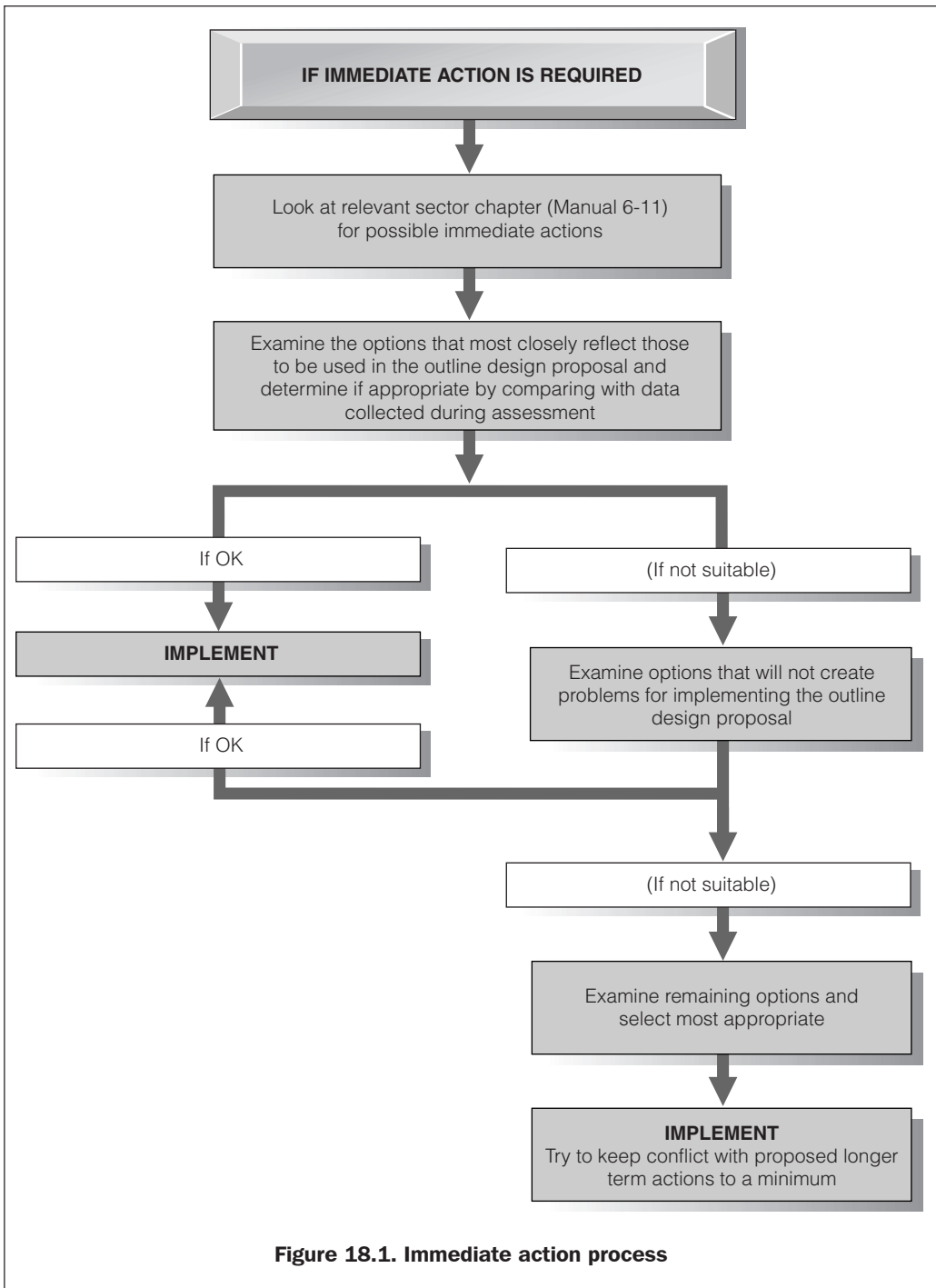

Figure 18.1. Immediate action process

18.3 Relationship with longer term activities

At this stage, the level of technology is basic to allow rapid implementation, and the emphasis should be on temporary emergency measures rather than long-term solutions. It is important, however, that the longer term plans produced in the outline programme design are taken into account and that conflict with these is minimised.

Once the immediate actions have been selected they need to be implemented immediately and rapidly. At this stage it is not possible to plan the implementation in detail, but care should be taken that decisions made now will not hinder or complicate the programme in later stages. For example, if a decision is made to pay workers from the affected community at this stage, it will be very difficult to mobilise community volunteers in future. It is therefore important that long-term aspects are considered from the onset.

It is likely that in the immediate action stage of an emergency, many of the practical activities will be conducted by agency staff with the help of a rapidly mobilised task force comprised of community volunteers. It is essential that only the basic **immediate** actions be conducted in this way. All longer term aspects of the programme must be properly planned and implemented in partnership with relevant stakeholders, according to the processes described in the detailed programme design.

EMERGENCY SANITATION

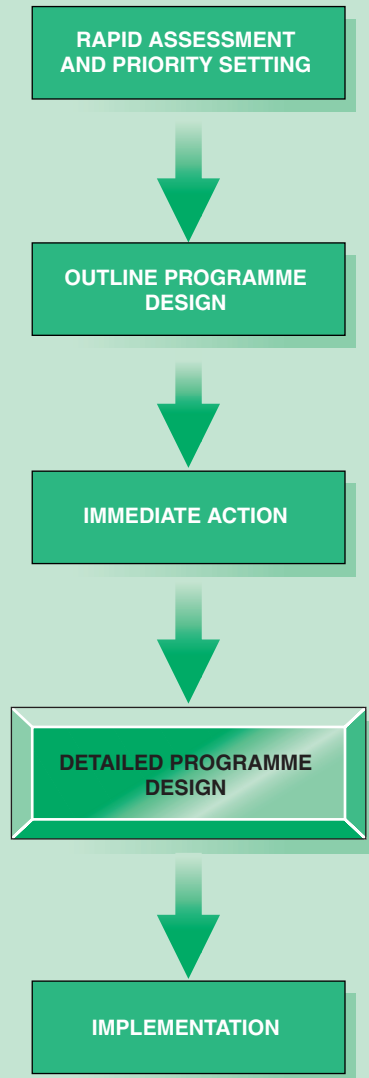

Chapter 19

Detailed programme design

Note: This section assumes that the outline programme design (described in Chapter 17) has already been conducted.

After the initial programme and budget approval, the detailed design process can be embarked upon. The objectives of this process are to gather additional information essential to the design and implementation of the programme; increase stakeholder ownership; develop demand; and improve decision-making. Further information can be found in Chapter 13 of the Manual.

19.1 Design process

The detailed design process is represented by Figure 19.1 below.

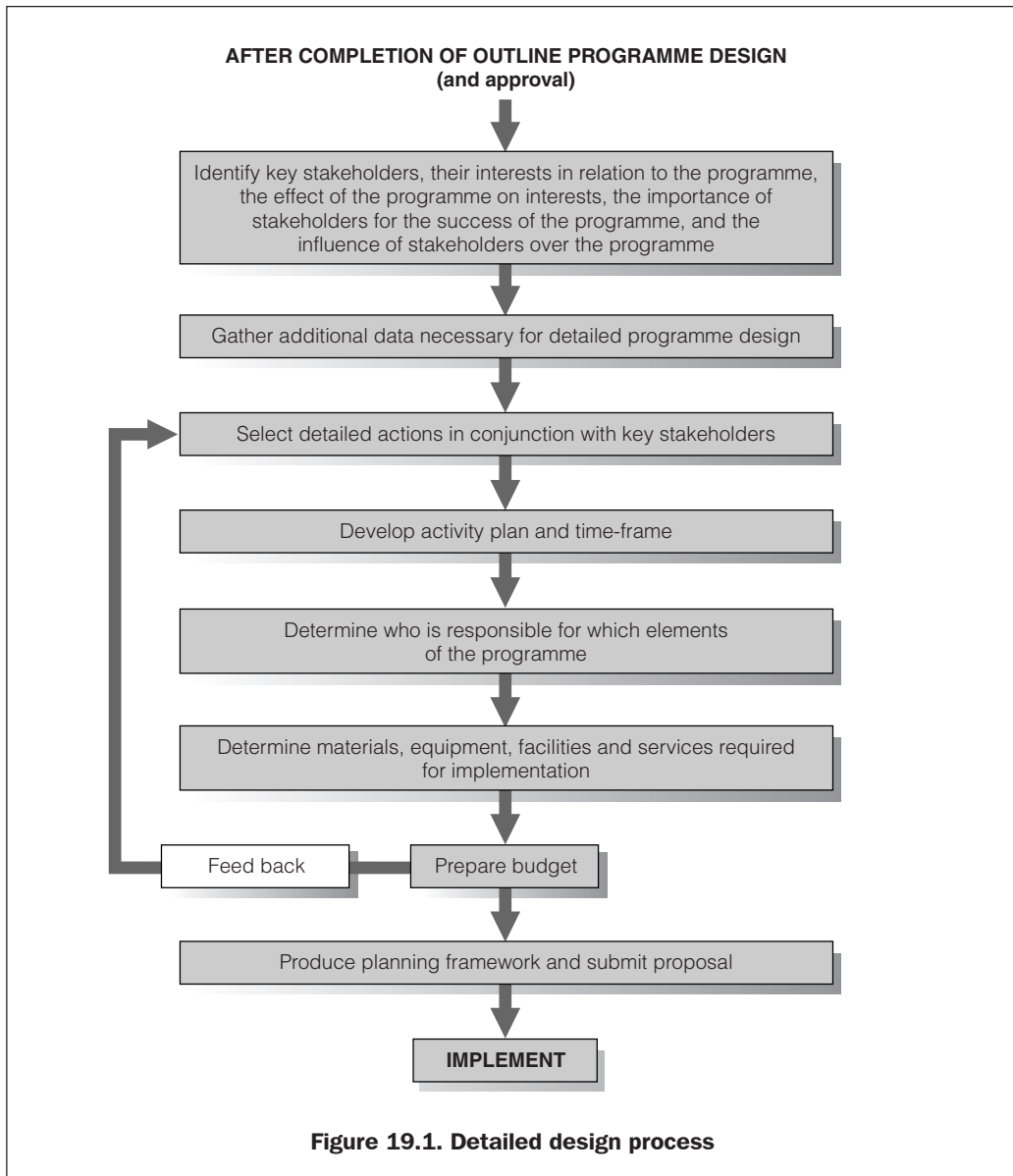

19.2 Stakeholder analysis

In order to assess the participation of different stakeholders in the affected area it is important firstly to identify them. Stakeholder analysis can help identify different interests in a programme, conflicts of interest, and the potential for co-operation and coalitions. The stakeholder analysis should help to assess which stakeholders are important for programme success. It can also help to assess appropriate and feasible roles for different stakeholders. The first stage in the process is to identify the key stakeholders; these may include any of the following:

- Key informants (e.g. health staff, engineers)
- General groups
- Formal leaders
- Focus groups (e.g. women’s groups)
- Households and individuals: men, women, children, and disabled people
- The agency
- Other agencies working in the affected area
- The donor

Table 19.1 can be used in stakeholder analysis to identify stakeholders and their respective interests, the likely effect of the project on these interests and the relative importance and influence of stakeholders. For more detailed explanation and examples refer to Chapter 13 of the Manual.

Table 19.1. Stakeholder analysis				
Stakeholders	Interests at stake in relation to project	Effect of project on interests	Importance of stakeholder for success of project	Influence of stakeholder over project

19.3 Gender and vulnerable groups

It is essential that people of a particular gender or people who are vulnerable in some way are not excluded from the consultation process. For this reason, focus groups such as women’s groups may be formed and become involved in the assessment and planning process. These may be independent groups of women formed on their own initiative to discuss certain issues, or may be groups of women encouraged to form for the purposes of a programme that is directed by an external agency. Similarly, vulnerable groups such as people with disabilities and children must be consulted so that they can contribute to programme objectives.

19.4 Community participation

Chapter 12

Many emergency programmes suffer from a lack of involvement by the affected population and other stakeholders; this may result in inappropriate interventions, unsuitable design of facilities, resentment, or apathy. It is therefore essential that the implementing agency consults and involves the affected population and other stakeholders directly, to ensure an open and ongoing dialogue about programme objectives and activities.

There is more to community participation than answering questions or volunteering manual labour. It is the right of all people to have a say in important decisions that affect their lives. Agencies, therefore, must involve a wide cross-section of stakeholders in the actual decision-making process. This will help to identify demand and develop a sense of ownership, which

will promote further participation and contribute to the overall effectiveness of the programme. In order to achieve this, a planning team consisting of key stakeholder representatives can be formed. Members should be selected carefully so that all stakeholder groups are represented. This team can be involved in assessment, action selection and programme design. There are several ways in which the planning team and the affected community as a whole may be involved:

19.4.1 Interviews and questionnaires

The simplest form of consultation is to interview affected community members through a series of prepared questions or questionnaires. These may be used to collect specific information that cannot be collected through observation alone. This might include private hygiene practices and personal preferences regarding various technical options.

19.4.2 RRA and PRA techniques

Rapid Rural Appraisal (RRA) and Participatory Rural Appraisal (PRA) are highly interactive techniques that involve the key stakeholders in the assessment and planning process. These can enable groups and individuals to become actively involved in each of the following:

- Mapping: community maps indicating key facilities, threats and opportunities
- Diagramming: key relationship diagrams
- Trend analysis: seasonal calendars and daily activity charts
- Ranking: priority ranking for sanitation problems, needs and preferences
- Discussing: discussion to identify key issues requiring further attention

Section 19.5 describes the baseline data required for detailed programme design; this will be collected through the consultation process. Stakeholders should also be involved in action selection and in developing the programme activity plan.

19.5 Baseline survey

Following the stakeholder analysis, a baseline survey - usually a questionnaire survey (qualitative and quantitative) - should be conducted before the detailed design is completed. This is necessary to establish pre-project conditions in the affected area, and should help identify:

- vulnerable groups;
- community management structures;
- socio-cultural aspects;
- the acceptability of programmes by affected population; and
- the involvement of different groups in the programme in the short and long term.

Questionnaire surveys can be conducted rapidly but often need lengthy analysis. Checklist H can be used for a qualitative household survey. In general, households may be randomly selected, although it is important to ensure that vulnerable groups are not excluded.

To minimise duplication, the assessor should avoid collecting any information that has already been collected in the rapid assessment, although some information may need updating. It is suggested that the factors and questions in the following sections be considered. Depending on the experience of the assessor much of this information may have been collected earlier.

Checklist H: Baseline survey

Excreta disposal

- Where do men defecate?
- Where do women defecate?
- Where do children defecate?
- Where do people who are disabled or sick defecate?
- Where do elderly people defecate?
- Who uses the existing latrines?
- What type of problems are they facing now?
- What anal cleansing materials are used?
- What are the handwashing practices after defecation?
- What are the handwashing practices after handling children's faeces?
- Are there any important beliefs and taboos related to the location and sharing of latrines?
- Who can participate in an excreta disposal programme and which aspects?
- Who is aware of the health benefits of improved excreta disposal and hygiene practices?
- What type of activities or materials would be best for increasing people's awareness?

Solid waste

- Who in the family collects and disposes of the solid waste?
- Where do they throw the waste?
- How far do they have to walk?
- Who can participate in a solid waste programme and in which aspects?
- Who would like to be involved in the recycling aspects of solid waste?
- Who is aware of the health benefits of improved solid waste and hygiene practices?
- Are there any complaints about the solid waste programme?

Waste management at medical centres

- Have you seen medical waste around your shelter or any other public place?
- Has medical waste caused any problem or injury to you or any member of your family?
- What do you do when you see medical waste?

Disposal of dead bodies

- Has anyone in your family died since the emergency started?
- What was the cause of death?
- Did you have access to a place to bury or cremate?
- What type of problems did you face with burial or cremation activities?
- Did you contact anyone to help you?

Wastewater management

- Does poor wastewater disposal or lack of drainage minimise your access to sanitation facilities and which ones?
- Where do you throw your wastewater?
- Who can participate in a wastewater programme and which aspects:
 - Construction?
 - Maintenance?
- Who is aware of the health benefits of improved wastewater and site drainage?

Checklist H: continued.....**Hygiene promotion**

- Do you know any hygiene promoter in the affected area?
- Do you have regular contact with them?
- Have you got or received hygiene promotion kits?
- What methods have been used to promote sanitation facilities and hygiene practices?
- What method should be used to make them more acceptable?
- If you have a problem with any of the sanitation facilities what do you do?
- Do you discuss these problems with anyone?
- Who do you consider your leader in the affected area?
- To what extent could you be involved in excreta disposal, solid waste and wastewater programmes?
- How you would like to be involved in HP activities?

19.6 Necessary action selection

Whilst the outline programme design will have included recommended interventions (or solutions), the detailed actions will not have been selected until now.

Necessary actions should include both hardware (technical) and software (social and institutional) aspects and should be acceptable to all key stakeholders. It is hoped that through this process the agency can ensure that the facilities provided are used and maintained on a regular basis, and that hygiene promotion methods are effective.

In order to ensure that actions are acceptable to them, stakeholders must be actively involved in the selection process, through meetings, interviews and group discussions and activities.

Tables 19.2 - 19.7 list various actions and technical options from which to select. These can be used to stimulate discussion and introduce options of which stakeholders may be unaware. It should be noted that these tables do not include the immediate action options (Chapter 18) but short and long-term options only. In deciding on each appropriate action the following questions should be answered satisfactorily:

Will the selected action:

- satisfy priority sanitation needs?
- be acceptable to all (especially primary and secondary) stakeholders?
- be sensitive to all religious and cultural beliefs?
- address the needs of vulnerable groups?
- address gender needs?
- involve the affected community?
- be affordable?
- be sustainable in operation and maintenance?

19.6.1 Excreta disposal**Chapter 6**

Most excreta disposal methods used in emergency situations are well known and described in a wide variety of publications. The various options are listed in Table 19.2 below, whilst actual design details are provided in the Manual.

Table 19.2. Excreta disposal options		
Latrine type	Technology choice	Responsibility for construction, O&M
Family latrine	Pour-flush latrine Simple pit latrine Borehole latrine Composting latrine	Family members Contractors (for borehole latrines only) Hygiene promotion team to promote and advise on family latrines
Communal latrine	Pour-flush latrine Water closet Overhung latrine Trench latrine Simple pit latrine (including raised and twin pit) VIP latrine	Community volunteers Agency staff Contractors Hygiene promotion to promote cleanliness and maintenance
Disabled latrine	Pour-flush latrine Simple pit latrine VIP latrine	Family members Community volunteers Agency staff Hygiene promotion team to identify vulnerable people and mobilise community

Important considerations such as location, space and available resources/personnel must also be included in the decision-making process. Particular reference is made in the Manual to difficult site conditions such as rocky ground, high water tables, unstable soil, and the effects of flooding.

19.6.2 Solid waste management

Chapter 7

The main options for solid waste management are listed in Table 19.3. It is important to consider personnel as well as methods of transportation and practical disposal options.

Table 19.3. Solid waste management options				
Disposal system	Storage	Transportation	Disposal	Responsibility for construction, O&M
On-site disposal	None	By foot	Family pits Communal pits Composting	Family members Community volunteers Agency staff
Off-site disposal	Communal bins Family bins Communal depots	Human-powered Animal-powered Machine-powered	Open pit Incineration Landfilling Composting	Community volunteers Agency staff Provision of protective clothing External personnel or contractors

19.6.3 Waste management at medical centres**Chapter 8**

Many of the issues that affect solid waste management affect equally the management of medical waste (Table 19.4). It is important, however, that medical waste is separated from general solid waste and disposed of in a hygienic way to avoid further spread of disease or infection.

Table 19.4. Waste management options at medical centres

<i>Disposal system</i>	<i>Segregation</i>	<i>Disposal</i>	<i>Transportation</i>	<i>Responsibility for construction, O&M</i>
On-site disposal	Sealed containers Designated bins	Incineration Sharps pit Pit disposal Landfilling	By foot	Medical staff Agency staff; Provision of protective clothing
Off-site disposal	Sealed containers Designated bins	Incineration Sharps pit Pit disposal Landfilling	Human-powered Animal-powered Motorised	Medical staff Agency staff Provision of protective clothing External personnel or contractors

19.6.4 Disposal of dead bodies**Chapter 9**

The disposal of dead bodies is obviously a sensitive issue and the choice of disposal method will depend primarily upon socio-cultural practice and expectations. In addition, safety, available resources and space must be considered, especially in cases of epidemics. Table 19.5 lists appropriate options.

Table 19.5. Disposal options for dead bodies

<i>Scenario</i>	<i>Transportation</i>	<i>Disposal</i>	<i>Responsibility for construction, O&M</i>
Stable situation	People-carried Cart Motor vehicle	Burial Cremation	Family members Community members
Medical epidemic (e.g. cholera)	Motor vehicle	Burial (following disinfection) Cremation (following disinfection)	Medical staff Agency staff Hygiene promotion to raise awareness of health risks

19.6.5 Wastewater management**Chapter 10**

Several options exist for the management of wastewater and they depend largely upon site conditions and available space. The options in Table 19.6 should be considered:

Further information on each option can be found in the Manual; it is likely that a combination of methods will be adopted.

DETAILED PROGRAMME DESIGN

Table 19.6. Wastewater management options

Ground conditions	Disposal	Treatment	Responsibility for construction, O&M
Permeable soil	Soakpit Infiltration trench Natural drainage Irrigation	Filter Grease trap Settlement tank	Agency staff Community volunteers mobilised through hygiene promotion External personnel or contractors
Non-permeable soil	Natural drainage Natural drainage Man-made drainage Evaporation pan Evapotranspiration bed Irrigation		

19.6.6 Hygiene promotion

Chapter 11

A typical hygiene promotion programme should focus on the following key aspects:

- promoting safe hygiene practice;
- promoting the appropriate use and maintenance of sanitation facilities; and
- promoting participation in sanitation programmes.

General options are provided in Table 19.7, from which a small number of activities should be selected at a time. The various methods that may be used for these activities are described in the Manual (Chapter 11).

Table 19.7. Hygiene promotion options

Objectives	Activities
Reduce high-risk hygiene practices	Promote safe disposal of faeces Promote handwashing after defecation, etc. Promote safe water use, storage and disposal Promote safe disposal of solid waste Promote safe handling and disposal of medical waste Promote increased hygiene in cases of epidemics
Promote appropriate use and maintenance of sanitation facilities	Promote appropriate use and maintenance of sanitation facilities Promote appropriate use of: latrines; solid waste facilities; wastewater disposal systems; medical waste facilities; or burial grounds.
Promote participation in programmes	Encourage families to construct their own latrines Recruit waterpoint and latrine attendants Mobilise community for clean-up campaigns Mobilise community for construction of drainage channels or other sanitation facilities

The above sector tables (Tables 19.2-19.6) also indicate relevant hygiene promotion activities to promote the construction and use of facilities.

19.7 Selection checklist

Once necessary actions have been selected, the checklist in Table 19.8 can be used to check the appropriateness of each action, and whether all the key issues have been considered.

Table 19.8. Selection checklist	
Issue	Relevant information
Segregation of facilities (gender issues)	
Cultural and religious beliefs	
Anal cleansing methods	
Addressing the needs of vulnerable groups	
Acceptability of technology to affected population	
Acceptability of sanitation sites to the affected population	
Upgradeability of selected technology	
Sustainability of technology	
Ease of procurement and transportation of materials and equipment	
Use of local materials without adverse effect on the environment	
Operation and maintenance of facilities	
Appropriate hygiene promotion activities for all sanitation facilities	
Acceptability of methods of dissemination to be used for hygiene promotion activities	
Addressing gender issues	
Community management and mobilisation	
Level of community participation	

This is designed to act as a final check before detailed design and implementation.

19.8 Developing the logical framework

The logical framework is a way of planning programmes and testing their internal logic through the planning process. The logical framework (Table 19.9) can be used to present the programme design in a logical fashion by linking means and ends, and this can form the basis for the activity plan. Further information can be found in the Manual (Chapter 13).

Table 19.9. Logical framework			
<i>Narrative summary</i>	<i>Measurable indicators</i>	<i>Means of verification</i>	<i>Important assumptions</i>
Goal:			
Purpose:			
Outputs:			
Activities:			
Inputs:			

19.9 Developing the programme activity plan

In order to develop an activity plan for the programme, the necessary actions selected need to be listed and considered in more depth.

It is important that the activity plan contains significant detail and demonstrates the use of needs-sensitive and appropriate design. In other words, it should be clearly seen that technical designs and implementation approaches incorporate stakeholder needs and preferences identified through the consultation process.

Whilst the selected actions will depend on many external factors such as availability of resources, site conditions, and the ability and experience of personnel, it is important that the programme design shows that a range of options has been considered. The reasons for selection should also be stated clearly so that the donor is able to follow the programme justification.

19.10 Developing the time frame for the activity plan

Once an activity plan has been drawn up, it is necessary to develop a time frame for its implementation. The planning team should be asked to estimate the time-frame required for each action, and these estimates can be used to develop a programme Gantt chart (Table 19.10).

It may be appropriate to ask different team members to estimate the duration of different activities. These can then be presented to the group, discussed and modified before completing the Gantt chart. Activity durations are likely to be measured in weeks or months, and participants should be encouraged to consider logistical and financial factors affecting implementation.

Ideally, all activities should be presented on a single programme Gantt chart:

Table 19.10. Example Gantt chart

Weeks/Months								
Activities	1	2	3	4	5	6	7	8

Activities can be broken down into shorter distinct periods during implementation (Chapter 20).

19.11 Determining responsibilities

The *personnel requirement* section of the programme proposal is intended primarily to show the number and category of salaried employees required, including both national and international staff. This may include job titles, brief job descriptions and reporting lines.

In addition, individuals and groups from the affected community who are to be responsible for the completion of specific activities should be identified. This can be done by asking the planning team to identify who will be best suited to take responsibility for each activity listed in the programme activity plan. This process should be followed by discussion to reach a group consensus for each activity.

19.11.1 Community volunteers

Some agencies have strict policies whereby community participants must be involved on a voluntary basis only, since they are also the beneficiaries. In practice, community volunteers often receive incentives such as additional food, and those with particular skills may receive money. Great care must be taken in deciding on such issues, in order to avoid unnecessary tensions or conflict. It is important that such decisions are made before implementation and worked into the detailed programme design.

19.12 Determining resources

In developing each sector action plan the planning team was asked to consider what resources would be required for the implementation of the selected actions. This can be developed further by asking the planning team to combine the elements investigated so far in a programme implementation plan (Table 19.11).

<i>Activities</i>	<i>Responsibilities</i>	<i>Equipment and materials</i>	<i>Facilities</i>	<i>Services</i>

19.12.1 Logistics

The logistics of moving personnel and resources to the project site is probably the key service required in any emergency programme. Inefficient or inadequate logistical systems can be the cause of much frustration in the field. For this reason it is important that efficient systems are set up as early as possible in the programme, and that where possible local resources requiring minimum transportation are used.

It is likely that the sanitation programme is only one component of the agency’s emergency programme in the area, and that a single logistical system will exist for all programme activities. For this reason it is important for personnel to consider the difficulties facing the logistics team and to plan intervention activities accordingly.

Any logistical system is likely to be complex and to include the following processes:

- Specification of goods and equipment required
- Communication with suppliers and agency headquarters
- Procurement and consignment (locally or internationally)
- Transportation (by land, air and water)
- Storage
- Stock control
- Distribution

In selecting technical options and planning activities it is essential that logistical structures and procedures be considered. Sources of different materials, procurement and delivery speed, and ease of transportation and storage should be considered. Options that may seem slightly less preferable technically may be much more appropriate in overall terms, once such aspects are taken into account.

The option of using local contractors, where available, should also be considered, since this may minimise the logistical demands made on the agency.

19.13 Preparing the budget

Good budgets are important if programmes are to be efficient and effective. It is important that sufficient attention is paid to all relevant costs for each of the following:

- Staff salaries
- Building materials
- Training materials
- Tools and equipment
- Transportation
- Administration
- Monitoring and evaluation

From this, a budget can be drawn up for each sanitation sector to be dealt with and this information can be summarised in the overall programme budget. Whilst the donor may be interested in value for money, the key concern is likely to be that the programme objectives can be fully achieved on schedule at reasonable cost, rather than only partly achieved or achieved later than schedule at low cost. It is therefore important that each cost is balanced against quality.

Some donors are keen to see the projected cost per beneficiary as a guide to the expected programme efficiency. This can be calculated from the following equation:

$$\text{Cost per beneficiary} = \frac{\text{total cost of sanitation programmes}}{\text{total number of beneficiaries}}$$

It is also important that cash is available in the field for local purchase and payment of staff or contractors. Requests for such cash should be made well in advance to ensure that the necessary amounts are available when required. Cash needs should therefore also be identified in the detailed programme design.

19.14 Feedback and refinement of plan of action

Once the plan of action has been completed and the budget has been drawn up, feedback should be given to all the key stakeholders. This is necessary to ensure that stakeholders are broadly in agreement with the proposal, that those included are able to carry out their responsibilities successfully and that any disadvantages to stakeholders are minimised. If necessary the plan of action may need to be refined as a result of this process. Once a consensus has been reached the logical framework and final proposal can be prepared.

19.15 Final programme proposal and approval

If required, the final programme design should be submitted to the agency headquarters for final approval from the donor and the release of funds. It is expected that donor funding criteria will be well known and that the design will incorporate these.

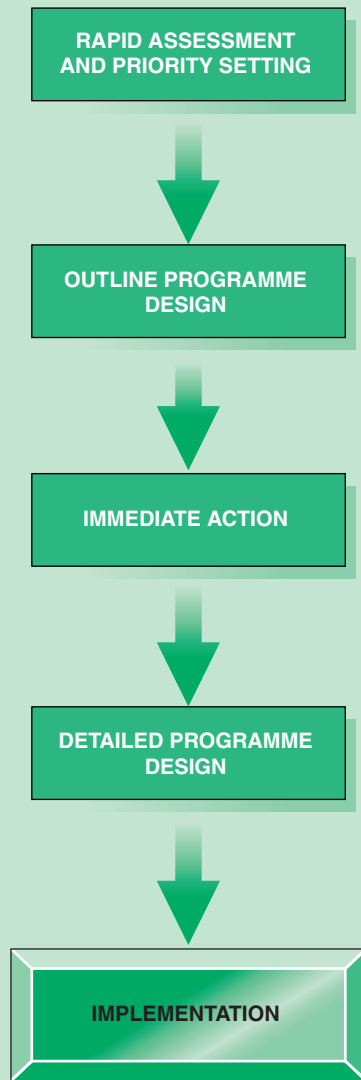

Chapter 20

Implementation

Once the detailed programme design is complete, implementation of the emergency sanitation programme can begin. It should be noted that immediate action is likely to be implemented in a less systematic way than longer term activities since this occurs before the detailed programme design is completed, but the same principles apply. The implementation time-scale is likely to be several months to several years, depending on the relevant scenario and programme. (Detailed supporting information can be found in the Manual, Chapter 14.)

20.1 What is implementation?

Implementation is transforming a planned programme into reality in the field. To ensure that implementation runs smoothly it is first necessary to have a properly thought-out plan, or programme design. Once the planning has been done, implementation is simply a question of managing the various programme components as efficiently and effectively as possible.

The primary objective of any emergency sanitation programme is to:

Improve and sustain the health and well-being of the affected population.

Such an objective is crucial and all activities should be geared towards this ultimate goal. Implementation targets are simply a means to an end and should always be viewed as such. An appropriate sanitation programme attempts to achieve the primary objective through the provision of appropriate and adequate sanitation facilities and improving hygiene practice - both elements need to be implemented equally effectively in order to compliment one another.

The term 'implementation' should not apply solely to the practical implementation of activities outlined in the detailed programme design. It should also apply to the day-to-day planning of those activities and how they are to be managed or co-ordinated. It also includes how contingencies are to be planned for and managed, and how the programme is to be monitored and evaluated. There are four important aspects to programme implementation:

- Planning
- Management
- Monitoring
- Evaluation

These guidelines will not address monitoring and evaluation in detail but their importance should be noted.

20.1.1 Implementation components

Implementation involves managing, planning for, monitoring and evaluating the seven key components indicated below. These components are used to form frameworks for implementation and monitoring.

- Staff
- Resources
- Finances
- Time
- Outputs
- Community
- Information

20.2 Implementation planning

The overall implementation planning process can be separated into the following steps (Figure 20.1); these can be conducted by agency staff in conjunction with the key stakeholders.

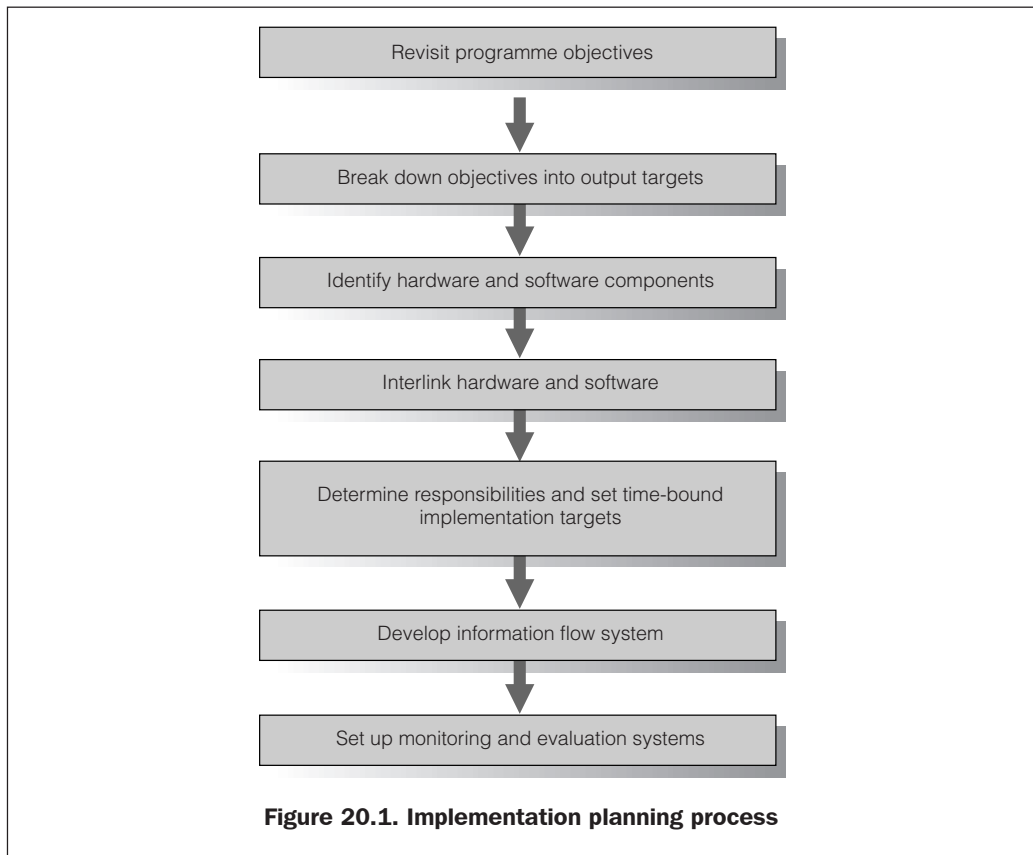

IMPLEMENTATION

A more detailed description of the implementation process with examples is provided below:

- 1. Programme objectives:** From the detailed programme design first chart out ‘the big picture’, work out the objectives in terms of both facility provision and hygiene promotion.
Example: To improve the health and well being of affected population through improved safe excreta disposal, solid waste management and hygiene promotion. To achieve this through appropriate use and maintenance, improved hygiene practice, and community empowerment.
- 2. Output targets:** Now break down the objectives into smaller, achievable and time-bound output targets, and set out plans to achieve these.
Example: Fifty communal latrines to be completed within two weeks; solid waste bin collection and disposal system to be in place within one month; hygiene promotion to address appropriate use and maintenance of communal latrines and waste bins for first month, and excreta disposal and handwashing practices for second month, etc.
- 3. Hardware and software:** Identify hardware and software components for each target, and to each of these allocate resources, staff and finances, and consider issues related to community participation.
Example: Hardware components of solid waste management include specifications and procurement of bins, transportation means and construction of disposal site. Software components include consultation with the affected community and other stakeholders concerning location of bins, collection and transportation system, location of disposal site and management and staff responsibilities.
- 4. Inter-linking:** Identify areas where hardware components and software components need to be inter-linked and where they can run separately from each other.
Example: While implementing a solid waste programme, specifications and procurement of bins and transport arrangements can be made, and discussion with the community on bin locations and collection systems can be conducted simultaneously. The location of the disposal site must be determined through consultation before construction can take place.
- 5. Implementation targets:** Determine who does what and set time-bound targets for staff, resources, finances, outputs and community participation (Section 20.3).
Example:

Week 1: Cash advance from finance and logistics request submitted; fifty solid waste bins procured; and consultation regarding bin locations and collection systems carried out.

continued.....

.... continued

Week 2: Transfer station constructed using local materials and existing labour force; team of ten solid waste workers recruited; and consultation regarding disposal site location carried out.

Week 3: Staff trained; and disposal site constructed.

Week 4: Four hand-carts and one tipper truck procured; system in place ready for operation.

6. Information flow: Develop an information flow system that runs through the technical team, hygiene promotion team, logistics, finance and key stakeholders such that every component of the programme is kept up-to-date on the activities of the others and information is fed into the implementation process in the field. This will also facilitate comprehensive monitoring and evaluation.

Example: Weekly reports prepared following a set format to reflect the situation on site and give information on quantity, quality and usage. A regular meeting plan developed with the team and other stakeholders.

7. Monitoring and evaluation: Make regular checks on the programme progress with respect to the targets developed for each of the implementation components (Section 20.5).

This process can be conducted with the assistance of the implementation framework (Table 20.1) to identify key factors and set appropriate targets.

20.3 Implementation framework

The seven key implementation components form the basis of an implementation framework consisting of both the key factors to be considered during implementation, and implementation targets. This framework is not an activity plan but a tool for conducting the implementation process. The implementation targets will be unique to the current programme and situation. The same targets can then be used as the basis for the monitoring and evaluation process.

The implementation framework can be applied to the implementation of sanitation facilities and hygiene promotion activities. The framework is divided into the seven key implementation components and targets are set for each, as indicated in Table 20.1.

IMPLEMENTATION

Table 20.1. Implementation framework		
Implementation component	Key factors to consider	Targets
Staff	Recruitment Training and capacity building Workshops Supervision and appraisal	Number of trained staff Number of staff from affected community Performance of staff
Resources	Procurement and transportation Feedback from logistics Meeting places Tools Construction materials Dissemination materials	Appropriate logistical procedures Appropriate meeting locations Use of local materials where possible Quantity of tools Quantity of materials
Finances	Budget control Cost-effectiveness of procurement and construction methods Feedback from finance department	Proposed budget lines Cost per beneficiary ratio
Time	Procurement and transportation Supervision of work Breakdown of activities into short distinct stages	Resource arrival times Facility completion times Specific periods where specific risk practices are targeted and specific activities promoted
Outputs	Completed facilities of appropriate quality and quantity Appropriate use and maintenance of facilities Appropriate sanitation systems Appropriate hygiene promotion activities Improved hygiene practice Improved health	Number of facilities Quality of facilities Cleanliness and state of facilities Efficiency of systems Incidence of risk practices (indiscriminate defecation, undisposed solid waste etc.) Mortality and morbidity rates
Community	Participation in design and construction Participation in operation and maintenance Participation in hygiene promotion activities Training and capacity building	Number of participants Levels of participation Levels of responsibility
Information	Reporting and planning Co-ordination between technical, hygiene and health teams, other agencies and affected community External technical information	Regular situation reports and plans Regular meetings

Implementation methods should be socio-culturally sensitive and should mirror those adopted locally wherever possible.

20.4 Implementation management

Once implementation begins it is essential that it is managed effectively. A recommended simple technique for implementation management is the ‘milestones’ approach.

20.4.1 Implementation by milestones

The targets set in the implementation framework can be used to produce a milestone management plan. This is a simple management tool which can be used by a multidisciplinary team. A milestones table should be produced for each intended project output. These outputs can be the same as those used in the logical framework or the implementation planning process.

The first step is to match specific targets, or ‘milestones’ to each output. These can include milestones for each of the implementation components which relate to a single project output. For example, the implementation of a solid waste management system may be broken down into milestones for staff recruitment and mobilisation, resource procurement and transportation, activities to promote hygiene and community awareness, as well as milestones for the physical construction or installation of facilities. These milestones can be presented as a list in the first column of a table.

The next step is to decide who is responsible for achieving each milestone and when it should be achieved. This can be presented as shown in Table 20.2.

Table 20.2. Implementation by milestones

<i>Selected milestones</i>	<i>Who</i>	<i>When</i>	<i>Current status and comments</i>

Once implementation commences the ‘current status and comments’ column can be used to record the progress towards achieving each milestone and any problems or constraints relating to these. This is a dynamic tool which can be used on a daily or weekly basis to measure progress, adjust implementation plans and determine which programme areas are most in need of attention. Any milestone plan is likely to be constantly changing as circumstances change. A completed example is presented in the Case Study.

20.4.2 Contingency planning

The milestones management method can be used to monitor programme progress and can be combined with an appropriate information flow system to pre-empt internal or external circumstances which may affect the programme. In emergency situations it is especially important that managers are ready to respond to rapid changes in the current situation. Appropriate contingency plans should be put in place to respond to possible scenarios such as a sudden influx of refugees or an outbreak of cholera. Effective programme management and monitoring will minimise the problems associated with such potentially volatile situations.

20.5 Monitoring

Once implementation begins it is essential to introduce effective monitoring of programme activities. Monitoring can be built into implementation management and is necessary to answer the following questions about the programme:

- Have the various activities been undertaken as specified in the programme design?
- Are materials and inputs reaching the affected population in good time?
- Are the provided facilities being used and maintained?
- Are hygiene promotion activities encouraging the affected population to participate in project/programme activities and to use the facilities provided?
- Are there any unexpected problems occurring and how can appropriate action be taken?

Effective monitoring is essential to ensure the success of the programme. There may sometimes be a tendency to monitor activities only during construction. If this is the case, however, it may be that new facilities are never used, and if monitoring is not on-going the reason for this will never be discovered. Monitoring of all aspects of the programme should continue for as long as the agency is operating in a given area. Time spent on this activity should ensure programme effectiveness and prevent mistakes from being repeated in future.

There are several techniques that can be used for monitoring (see 14.10). A number of these are described briefly below.

20.5.1 SWOT analysis

A useful monitoring tool is a SWOT (Strengths, Weaknesses, Opportunities and Threats) analysis. This can be done simply by brainstorming under the following headings:

- Strengths: Those things that have worked
- Weaknesses: Those things that have not worked so well or could be improved
- Opportunities: Conditions which are favourable and can be taken advantage of by the programme
- Threats: Threats which reduce the range of opportunities for improvement

20.5.2 Log-frame analysis

Another method of monitoring is to use the logical framework produced in the detailed programme design. This can be done by using the measurable indicators for outputs and objectives which were identified at the planning stage. Each indicator can be used to test whether the programme has achieved the planned outputs. This is explained in more detail in the manual.

20.5.3 Checklist analysis

A useful monitoring tool for more in-depth analysis is to repeat the rapid assessment and priority setting process (Chapter 16) for each sanitation sector relevant to the programme. If each relevant checklist and analysis table is completed, the sub-totals and overall total can be compared with those reached during the initial rapid assessment. This will give a quantifiable indicator of the overall situation improvement for that particular sector. A worked example is presented in the Case Study.

The stakeholder planning team may also be involved in any of these processes, which can be used at any stage of monitoring or in programme evaluation.

20.5.4 Monitoring reports

It is essential that the results of any monitoring exercise are reported and that these are used to revise and amend implementation plans. The most simple form of monitoring report is a weekly situation report but more detailed reports can be produced based on each or all of the monitoring techniques described above. Completed examples of various monitoring reports are provided in the Case Study.

Fieldworkers should produce a weekly situation report (sitrep) to record progress made during the past week, any changes in the current situation and amended future plans. This may be a very brief report, but weekly reports may be used to feed into more detailed monthly monitoring reports. (Table 14.6 shows a recommended simple reporting format which incorporates the key components of implementation.)

20.6 Evaluation

Programme evaluation is an assessment of an ongoing or completed programme, in terms of its design, implementation and outputs. This evaluation can be built on the monitoring process and is designed to answer the following questions:

- Have the programme aims, activities and outcomes been appropriate?
- Have the initial programme purpose and objectives been fulfilled?
- Have the recommended minimum objectives been satisfied?
- Has the programme been effective?
- Has the programme been efficient?
- Has the programme been equitable?
- Has the programme had any other effects?
- Are the outputs sustainable over their design life?

Generally, evaluation is conducted at, or towards, the end of the programme. An interim evaluation, or review, can be carried out during the programme and may be more useful in identifying and remedying weaknesses. (Table 14.5 represents a simple framework for evaluation.)

20.6.1 Cost-effectiveness

Calculation of cost-effectiveness is a useful tool to investigate whether the programme has been efficient in terms of resources versus outputs. Some agencies or donors may require a cost-effectiveness evaluation. A simple method of measuring cost-effectiveness is establishing the *cost per beneficiary* for each programme activity (see 19.13). Cost-effectiveness targets can be set in the programme design and implementation framework and then compared to the final values achieved.

If the programme is to be cost-effective, the benefits to the target population must be greater than the overall costs of running the programme to the community, donor and implementing agency. The cost per beneficiary ratio can be calculated for the overall sanitation programme or for each sanitation sector and incorporated into the overall evaluation.

20.6.2 Evaluation reports

An evaluation report should be designed for use by the following groups:

- Programme staff
- Affected community
- Implementing agency support staff
- Other agencies or staff
- The donor
- Researchers/trainers
- Staff working on future sanitation programmes

It is important that the results of any evaluation are reported and studied, otherwise the evaluation process is pointless. If used properly, programme evaluation can be a very useful tool to learn from and improve emergency sanitation programmes. (A suggested structure for an evaluation report is shown in Table 14.7.)

Case study: Kala Refugee Camp,
Luapula Province, Zambia

March – August 2001

Contents

C1.	Introduction	295
C2.	Rapid assessment and priority setting	295
	Background information	296
	Excreta disposal	298
	Solid waste management	310
	Waste management at medical centres	317
	Disposal of the dead	320
	Wastewater management	322
	Hygiene promotion	324
	Priority setting results	327
C3.	Outline programme design	328
	Solid waste management	329
	Waste management at medical centres	330
	Hygiene promotion	331
C4.	Detailed programme design	332
	Hygiene promotion	332
C5.	Implementation management	335
C6.	Monitoring	336
	Checklist analysis	336
	SWOT analysis	339
	Monitoring framework	340
	Situation report	341
C7.	Evaluation	343
	Summary	343
	Programme justification	343
	Activities	343
	Outputs	344
	Resources	344
	Evaluation framework	344
	Conclusions	346
	Recommendations	346

C1. Introduction

This case study is designed to provide worked examples of how the Guidelines process is applied in the field. During 2001 WEDC undertook a period of field-testing in Kala refugee camp in Zambia, with the support and assistance of Médecins Sans Frontières (MSF), Holland. During field-testing the following sections of the Guidelines were used:

- **Rapid assessment and priority setting** - completion of assessment checklists and tables
- **Outline programme design** - outline plan of action produced
- **Detailed programme design** - detailed Gantt chart, logical framework and budget produce
- **Implementation** - monitoring and evaluation exercises conducted

This case study cannot include every single detail recorded during field-testing but hopefully provides a useful overview through presenting specific examples. All examples are from actual field practice but the interpretations and opinions expressed are solely those of the authors.

C2. Rapid assessment and priority setting

The rapid assessment and priority setting process was conducted by completing the checklists for each sanitation sector. Where there are several different types of facility within one sector, a checklist has been produced for each. These have been simplified slightly for the purposes of this book. For each checklist a sector analysis table has been completed; all tables have been reproduced. All recorded data is then combined in the final priority setting table.

Checklists A-G show the recorded assessment information.

- Checklist A: Background information
- Checklist B: Excreta disposal
- Checklist C: Solid waste (SW) management
- Checklist D: Waste management at medical centres
- Checklist E: Disposal of dead bodies
- Checklist F: Wastewater (WW) management
- Checklist G: Hygiene promotion

Completed sector analysis tables follow each checklist.

EMERGENCY SANITATION

Checklist A: Background information

March 2001

General description

Kala refugee camp lies in Luapula province in north-eastern Zambia. The camp was set up in August 2000 for Congolese refugees fleeing civil strife in the Democratic Republic of Congo (DRC). The current population of the camp is 14,000 and the average family size is four. There are no figures for the breakdown of the population by sex or vulnerability. The population is currently steadily increasing by approximately 350 people per week. World Vision is responsible for camp management and MSF Holland is responsible for health, water supply and sanitation, although they hope to pull out by the end of the year. The local government provides police for camp security and UNHCR co-ordinates the relief effort.

The site is gently sloping with a freshwater source which is being treated and pumped to distribution points within the camp. The soil is a clayey loam and the current (wet season) water table is at a depth of approximately 2.5m. The space available per person is approximately 45m². There is a large swampy area adjacent to the camp but drainage within the dwelling areas is generally adequate. The wet season lasts from November to April and there is generally no rainfall at all between June and September. Table C1 is a summary of general background information.

Table C1. General information

Location	Kala refugee camp, Zambia
Date	24/03/01
Organisation carrying out the assessment	MSF Holland; WEDC
Name of assessor(s)	Joseph N'gambi; Peter Harvey
Position of assessor(s)	Watsan Engineer; Researcher
Dates of assessment	18/03/01 - 24/03/01
Maximum level of intervention (short-term or long-term)	Long-term level
General location of affected area or site	Scrub woodland, adjacent to swampy plain
Nature of emergency and likely resolutions	Civil strife/unrest in DRC, no indication of likely resolution or return to DRC
Origin of affected population	DR Congolese refugees, few local Zambians
Seasonal/climatic implications	1000mm/year rainfall, wet season Nov.-Apr.
Government involvement	Zambia police present at camp, responsible for security
Relationship between local and displaced populations	Low local population but relationship reported to be good with minimal conflict
Other organisations working in the area	UNHCR (humanitarian co-ordination); World Vision (camp management and social affairs)

CASE STUDY

Geographical informaton

A map of the camp layout is shown in Figure C1.

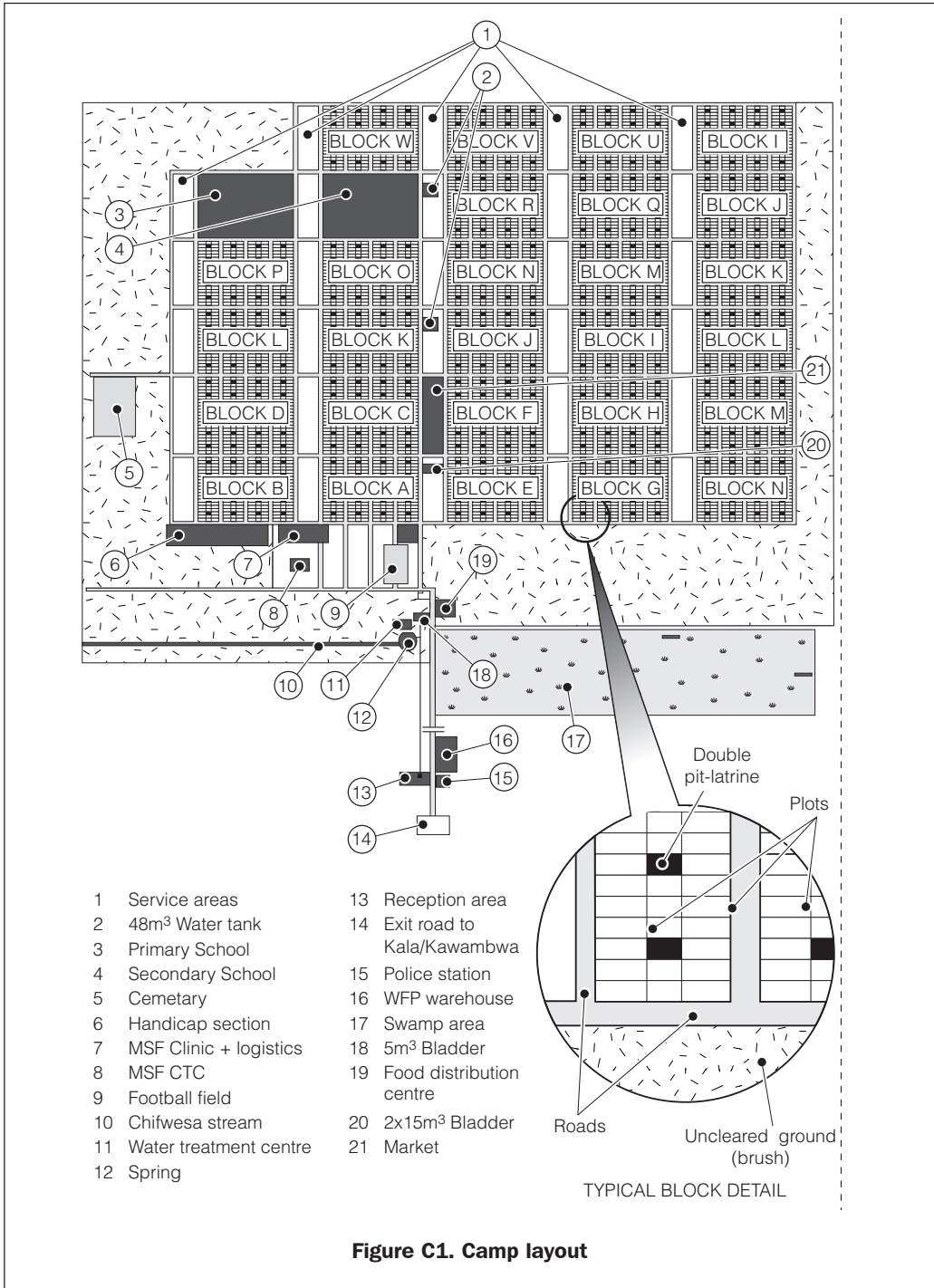

Figure C1. Camp layout

Checklist B: Excreta disposal

March 2001

General description

Good quantity and distribution of communal latrines, generally hygienically used and maintained. Low usage of covers on drop-holes, however, and plastic sheeting over superstructure produces uncomfortably hot interior. Concrete latrine slabs are thicker than necessary (approx.10cm), with no foot-rest positions, and are often poorly seated above pit. Corn-cobs are most commonly used for anal cleansing.

Family latrines (situated in Blocks A-F only) provide a better level of service in terms of quantity and quality but this distinction is not crucial. The families are responsible for pit excavation and superstructure construction (from mud, timber and grass), whilst MSF provides a reinforced concrete latrine slab. MSF workers presently construct latrines for vulnerable households in these areas.

Latrines for the disabled and at schools and health facilities are generally acceptable. The newly constructed VIP latrines at the health post are of very good quality.

Latrines at the reception centre are poorly constructed, used and maintained. Although an MSF team cleans and disinfects facilities daily, many new arrivals have to stay for several days and do not use the latrines provided, due to overcrowding.

One general checklist has been completed and a table has been completed for each of the following:

- domestic communal latrines;
- domestic family latrines;
- latrines for special groups (visually impaired);
- latrines at schools;
- latrines at the medical centre; and
- latrines at the reception centre.

Quality

1. Existing facilities are technically appropriate in general, although some spaces are too small and plastic sheeting makes communal latrines hot inside.
2. Existing facilities are generally socio-culturally acceptable to users, although there is no access for young children; and some users expressed preference for family units.
3. Potential hazards for disease transmission include contact with children's faeces and lack of drop-hole covers.
4. Current facilities and practices are sustainable for at least one year; average pit size 4m³ for 16 users.

Quantity

1. Ratio of domestic facilities (cubicle or space) to population is 1/16 for communal; and 1/4 family.
- 1b. Ratio of facilities in public places or institutions: 1/25 schools; 1/80 beds at medical centre; and 1/(18-70) at reception centre.
2. Maximum one-way walking distance for users: 15-30m

Usage

1. Proportion of the affected population with access to appropriate facilities: 75%-90%
2. Proportion of the affected population using the appropriate facilities correctly on a regular basis: 50% (reception centre); otherwise >90%

B. Excreta disposal
B.1-3 Domestic excreta disposal

Location of assessment:..... **Kala camp, Zambia**..... Date:..... **19/03/01**..... Assessor:..... **P Harvey**.....
 This table should be completed for each of the following as appropriate (underline or circle the relevant):
B.1 Single or shared family latrines **B.2 Domestic communal latrines** **B.3 Latrines for special groups**

Data	Collected data	B	Range 10	7			4		1	M	C
				inappropriate	technically basic	appropriate	acceptable	very appropriate			
Technical appropriateness	Gen. OK but spaces small, hot interior, slab unstable	5	inappropriate	technically basic	appropriate	very appropriate	0.25	1.25			
Social and cultural acceptability	Some people would prefer family latrines	5	very unacceptable	unacceptable	acceptable	very acceptable	0.25	1.25			
Potential hazard to health	No drop-hole covers, not used by young children	5	major hazard	basic protection	minimal hazard	no hazard	0.25	1.25			
Sustainability of facilities	4m³ pits: > 1 year	1	None	1 month	6 months	>1 year	0.25	0.25			
Ratio of latrine spaces to population	1/16 on average	1	None	1/100 or immediate responses	1/50	1/20	0.5	0.5			
Maximum one-way walking distance	30m	2	>100m	75m	50m	<25m	0.5	1.0			
% of population with access to appropriate facilities	80%	3	None	50%	75%	>95%	0.5	1.5			
% of population using appropriate facilities correctly	80%	3	None	50%	75%	>95%	0.5	1.5			
Total									8.5		

B.1-3 Domestic excreta disposal

Kala camp, Zambia

Date: 19/03/01

Assessor: P. Harvey

Location of assessment:

This table should be completed for each of the following as appropriate (underline or circle the relevant):

B.1 Single or shared family latrines B.2 Domestic communal latrines B.3 Latrines for special groups

Data	Collected data	B	Range 10	7			4	1	M	C
				10	7	4				
Technical appropriateness	Gen. OK but slabs often poorly seated	3	inappropriate	technically basic	appropriate	very appropriate	0.25	0.75		
Social and cultural acceptability	Good privacy, traditional materials	3	very unacceptable	unacceptable	acceptable	very acceptable	0.25	0.75		
Potential hazard to health	Well maintained but not used by young children	4	major hazard	basic protection	minimal hazard	no hazard	0.25	1.0		
Sustainability of facilities	>1 year	1	None	1 month	6 months	>1 year	0.25	0.25		
Ratio of latrine spaces to population	1/4	1	None	1/100 or immediate responses	1/50	1/20	0.5	0.5		
Maximum one-way walking distance	15m	1	>100m	75m	50m	<25m	0.5	0.5		
% of population with access to appropriate facilities	>95%	1	None	50%	75%	>95%	0.5	0.5		
% of population using appropriate facilities correctly	>95%	1	None	50%	75%	>95%	0.5	0.5		
Total								4.8		

CASE STUDY

B.1-3 Domestic excreta disposal

Location of assessment: Kala camp, Zambia Date: 19/03/01 Assessor: P Harvey

This table should be completed for each of the following as appropriate (underline or circle the relevant):
B.1 Single or shared family latrines B.2 Domestic communal latrines B.3 Latrines for special groups

Data	Collected data	B	Range 10	7			4			1			M	C
				10	7	4	1	7	4	1	7	4		
Technical appropriateness	Gen. OK good additional space	4	inappropriate	technically basic	appropriate	very appropriate	0.25	1.0					0.25	1.0
Social and cultural acceptability	Gen. Acceptable	4	very unacceptable	unacceptable	acceptable	very acceptable	0.25	1.0					0.25	1.0
Potential hazard to health	Minimal	4	major hazard	basic protection	minimal hazard	no hazard	0.25	1.0					0.25	1.0
Sustainability of facilities	>1 year	1	None	1 month	6 months	>1 year	0.25	0.25					0.25	0.25
Ratio of latrine spaces to population	Apx. 1/20	1	None	1/100 or immediate responses	1/50	1/20	0.5	0.5					0.5	0.5
Maximum one-way walking distance	<15m	1	>100m	75m	50m	<25m	0.5	0.5					0.5	0.5
% of population with access to appropriate facilities	>95%	1	None	50%	75%	>95%	0.5	0.5					0.5	0.5
% of population using appropriate facilities correctly	>95%	1	None	50%	75%	>95%	0.5	0.5					0.5	0.5
Total													5.3	

B.4 Excreta disposal for public places

Location of assessment: **Kala camp, Zambia** Date: **19/03/01** Assessor: **P. Harvey**
 This table should be completed for each of the following as appropriate (underline or circle the relevant):

Schools Markets Feeding centres

Data	Collected data	B	Range 10			M		C
			7	4	1			
Technical appropriateness	As domestic latrines	5	inappropriate	technically basic	appropriate	very appropriate	0.25	1.25
Social and cultural acceptability	Generally acceptable but no sex segregation	5	very unacceptable	unacceptable	acceptable	very acceptable	0.25	1.25
Potential hazard to health	No handwashing facilities	6	major hazard	basic protection	minimal hazard	no hazard	0.25	1.5
Sustainability of facilities	> 1 year	1	None	1 month	6 months	> 1 year	0.25	0.25
Ratio of latrine spaces to health centre beds / patients OR			None	1/50 beds 1/100 outpatients	1/20 beds 1/50 outpatients	1/10 beds 1/20 outpatients	0.5 OR	
Ratio of latrine spaces to school pupils OR	1/25	2	None	1/50 girls 1/100 boys	1/30 girls 1/60 boys	1/15 girls 1/30 boys	0.5 OR	1.0
Ratio of latrine spaces to market stalls OR			None	1/100 stalls	1/50 stalls	1/20 stalls	0.5 OR	
Ratio of latrine spaces to population at feeding centres			None	1/100	1/50	1/20	0.5	

continued

B.2 Excreta disposal for public places

.... continued

Data	Collected data	B	Range				M	C
			10	7	4	1		
Maximum one-way walking distance	25m	1	>100m	75m	50m	<25m	0.5	0.5
% of population with access to appropriate facilities	All pupils	1	None	50%	75%	>95%	0.5	0.5
% of population using appropriate facilities correctly	Well maintained and used by all pupils	1	None	50%	75%	>95%	0.5	0.5
Total							6.8	

B.4 Excreta disposal for public places

Location of assessment: Kala camp, Zambia Date: 19/03/01 Assessor: P. Harvey

This table should be completed for each of the following as appropriate (underline or circle the relevant):

Medical centres Schools Markets Feeding centres

Data	Collected data	B	Range			M	C	
			10	7	4			1
Technical appropriateness	New latrines very good, older slabs unstable	3	inappropriate	technically basic	appropriate	very appropriate	0.25	0.75
Social and cultural acceptability	Generally acceptable + sex segregation	3	very unacceptable	unacceptable	acceptable	very acceptable	0.25	0.75
Potential hazard to health	Minimal, slippery surfaces	4	major hazard	basic protection	minimal hazard	no hazard	0.25	1.0
Sustainability of facilities	> 1 year	1	None	1 month	6 months	> 1 year	0.25	0.25
Ratio of latrine spaces to health centre beds / patients OR	4/80 beds = 1/20 4/250 OP = 1/60	4	None	1/50 beds 1/100 outpatients	1/20 beds 1/50 outpatients	1/10 beds 1/20 outpatients	0.5 OR	2.0
Ratio of latrine spaces to school pupils OR			None	1/50 girls 1/100 boys	1/30 girls 1/60 boys	1/15 girls 1/30 boys	0.5 OR	
Ratio of latrine spaces to market stalls OR			None	1/100 stalls	1/50 stalls	1/20 stalls	0.5 OR	
Ratio of latrine spaces to population at feeding centres			None	1/100	1/50	1/20	0.5	

continued

B.2 Excreta disposal for public places

.... continued

Data	Collected data	B	Range				M	C
			10	7	4	1		
Maximum one-way walking distance	25m	1	>100m	75m	50m	<25m	0.5	0.5
% of population with access to appropriate facilities	90%	1	None	50%	75%	>95%	0.5	0.5
% of population using appropriate facilities correctly	90%	1	None	50%	75%	>95%	0.5	0.5
Total							6.3	

B.4 Excreta disposal for public places

Location of assessment: Kala camp, Zambia..... Date: 19/03/01..... Assessor: P. Harvey.....

This table should be completed for each of the following as appropriate (underline as appropriate (underline or circle the relevant):

Medical centres Schools Markets Reception centres

Data	Collected data	B	Range				M	C
			10	7	4	1		
Technical appropriateness	Pits too small, erosion, slabs poorly seated	7	inappropriate	technically basic	appropriate	very appropriate	0.25	1.75
Social and cultural acceptability	Odour/lack of maintenance	6	very unacceptable	unacceptable	acceptable	very acceptable	0.25	1.5
Potential hazard to health	Strong odour, flies, open defecation	7	major hazard	basic protection	minimal hazard	no hazard	0.25	1.75
Sustainability of facilities	3 months	6	None	1 month	6 months	> 1 year	0.25	1.5
Ratio of latrine spaces to health centre beds / patients OR			None	1/50 beds 1/100 outpatients	1/20 beds 1/50 outpatients	1/10 beds 1/20 outpatients	0.5 OR	
Ratio of latrine spaces to school pupils OR			None	1/50 girls 1/100 boys	1/30 girls 1/60 boys	1/15 girls 1/30 boys	0.5 OR	
Ratio of latrine spaces to market stalls OR			None	1/100 stalls	1/50 stalls	1/20 stalls	0.5 OR	
Ratio of latrine spaces to population at feeding centres	1/18 - 1/70	4	None	1/100	1/50	1/20	0.5	2.0

continued

B.2 Excreta disposal for public places

.... continued

Data	Collected data	B	Range				M	C
			10	7	4	1		
Maximum one-way walking distance	25m	1	>100m	75m	50m	<25m	0.5	0.5
% of population with access to appropriate facilities	75%	4	None	50%	75%	>95%	0.5	2.0
% of population using appropriate facilities correctly	>50%	8	None	50%	75%	>95%	0.5	4.0
Total								15.0

EMERGENCY SANITATION



Kala refugee camp



Pit latrine construction

CASE STUDY



Preparation of concrete latrine slabs



Family pit latrine under construction

Checklist C: Solid waste management

March 2001

General description

Solid waste management at Kala camp is generally ineffective and is especially poor at the market where large volumes of undisposed solid waste are clearly visible and there is no appropriate system for collection, transport and disposal. Solid waste management at the reception centre is also currently insufficient, although workers clean the site daily.

In general, there is very low coverage of family garbage pits which are poorly designed and neither covered nor replaced when full. Household waste is largely organic but in general is not disposed of appropriately.

Communal solid waste pits are currently under construction (Blocks A-F only) but are not yet in operation. Pits of depths above 2.5m are currently intercepting the water table.

Quality

1. Facilities and systems are technically basic in most areas.
2. Potential hazards for disease transmission: flies, mosquitoes breeding in communal pits, vermin around market and reception centre; and waste workers are currently not provided with protective clothing.
3. Current appropriate disposal systems can be sustained for >1 year (communal) and a few months (family).

Quantity

1. Ratio of pit volume per day to population is 7m³/32 people.
2. Maximum walking distance to the nearest pit, bin or container is <30m (communal pits); and <15m (family pits).

Usage

1. Proportion of the population using appropriate collection facilities correctly: <50%.
2. Proportion of collected SW transported to approved disposal sites: <50%.
3. Proportion of collected SW disposed of appropriately: <50%.

C. Solid waste management

C.1 Family or communal pit disposal (on-site)

Location of assessment: kaqa camp, Zambia..... Date: 19/03/01..... Assessor: P. Harvey.....

This table should be completed for each of the following as appropriate (underline or circle the relevant):

Domestic/dwelling areas Markets Feeding centres Schools

Data	Collected data	B	Range				M	C
			10	7	4	1		
Technical appropriateness	Technical basic	7	inappropriate	Technically basic	appropriate	very appropriate	0.33	2.3
Potential hazard to health	Flies, mosquitoes	6	major hazard	Basic protection	minimal hazard	no hazard	0.33	2.0
Sustainability of facilities	Few months	7	None	1 month	6 months	>1 year	0.33	2.3
Ratio of pit volume (per day) to population	1m³/4 6m³/24	1	None	6m ³ /200	6m ³ /100	6m ³ /50	0.5	0.5
Maximum one-way walking distance to family pit OR	<15m	1	>70m	45m	30m	15m	0.5 OR	0.5
Maximum one-way walking distance to communal pit			>250m	200m	150m	100m	0.5	
% of population with access to appropriate facilities	<50%	8	None	50%	75%	>95%	0.5	4.0
% of population using appropriate facilities correctly	<50%	8	None	50%	75%	>95%	0.5	4.0
Total							15.6	

C.3 Communal waste collection (without bins) and disposal (off-site)

Location of assessment:..... **Kala camp, Zambia** Date:..... **19/03/01** Assessor:..... **P. Harvey**

This table should be completed for each of the following as appropriate (underline or circle the relevant):

Markets Feeding centres Schools

Data	B	Range			M	C		
		10	7	4			1	
Technical appropriateness	8	Inappropriate	inappropriate	technically basic	appropriate	very appropriate	0.33	2.7
Potential health hazard	8	Fires, vermin, kids playing	major hazard	basic protection	minimal hazard	no hazard	0.33	2.7
Sustainability of facilities	9	< 1 month	None	1 month	6 months	> 1 year	0.33	3.0
Ratio of collection vehicle volume (per day) to unit of measure	10	None	None	0.2/ person or 5/stall	0.4/ person or 10/stall	1.0/ person or 20/stall	0.33	3.3
Distance to final disposal site from nearest habitable building	10	< 10m	<250m	500m	750m	> 1km	0.33	3.3
Land available for land filling per day OR			None	0.25m ³ /person	0.50m ³ /person	0.75m ³ /person	0.33 OR	
Ratio of pit volume (per day) to population	9	Virtually none	None	6m ³ /200	6m ³ /100	6m ³ /50	0.33	3.0

continued

C.3 Communal waste collection (without bins) and disposal (off-site)

.... continued

Data	Collected data	B	Range				M	C
			10	7	4	1		
% of population using appropriate collection facilities correctly	None	10	None	50%	75%	>95%	0.33	3.3
% of collected solid waste transported correctly	None	10	None	50%	75%	>95%	0.33	3.3
% of collected solid waste disposed of correctly	None	10	None	50%	75%	>95%	0.33	3.3
							T-al	28.0

C.3 Communal waste collection (without bins) and disposal (off-site)

Location of assessment: **Kala camp, Zambia** Date: **19/03/01** Assessor: **P. Harvey**

This table should be completed for each of the following as appropriate (underline or circle the relevant):

Markets Reception centres Schools

Data	Collected data	B	Range			M	C
			10	7	4		
Technical appropriateness	Capacity too low	7	inappropriate	technically basic	appropriate	very appropriate	2.3
Potential health hazard	Flies, vermin, no clothing	7	major hazard	basic protection	minimal hazard	no hazard	2.3
Sustainability of facilities	<1 month	8	None	1 month	6 months	> 1 year	2.7
Ratio of collection vehicle volume (per day) to unit of measure	130l wheelbarrow x 2 trips	1	None	0.2/ person or 5/stall	0.4/ person or 10/stall	1.0/ person or 20/stall	0.3
Distance to final disposal site from nearest habitable building	<20m	10	<250m	500m	750m	> 1km	3.3
Land available for land filling per day OR			None	0.25m ³ /person	0.50m ³ /person	0.75m ³ /person	0.33 OR
Ratio of pit volume (per day) to population	Virtually none	9	None	6m ³ /200	6m ³ /100	6m ³ /50	0.33

continued

C.3 Communal waste collection (without bins) and disposal (off-site)

.... continued

Data	Collected data	B	Range				M	C
			10	7	4	1		
% of population using appropriate collection facilities correctly	50%	7	None	50%	75%	>95%	0.33	2.3
% of collected solid waste transported correctly	90%	2	None	50%	75%	>95%	0.33	0.7
% of collected solid waste disposed of correctly	75%	4	None	50%	75%	>95%	0.33	1.3
Total								18.2

EMERGENCY SANITATION



Market solid waste



Domestic solid waste

Checklist D: Waste management at medical centres

March 2001

General description

Segregation of different types of waste at source is currently ineffective, storage and transportation facilities are generally inappropriate, and training and support to staff is insufficient. Open containers used to segregate waste are unsafe, workers have no gloves or protective clothing, and have received no training.

The open pit for disposal of general waste is poorly managed and too close to the health post. Medical waste (including sharps) is mixed with general waste in the burner (which is unable to incinerate sharps) and the combusted waste is disposed of in a sealed pit. Placentas are currently buried in a designated area at the rear of the health post, which is socio-culturally acceptable although the site requires some management.

Quality

1. Facilities and systems are technically basic.
2. Potential hazards for disease transmission: open pit, insects, etc.; open containers without lids for sharps and infectious waste; and no protective clothing.
3. The current disposal system can be sustained for about a month.

Quantity

1. Average number of beds for each set of three segregated containers (sharps, medical, general): 20
2. Average walking distance to the container(s): 3m
3. Volume of the transport system from container to final disposal point: insufficient
4. Ratio of original pit volume per bed: 700l/bed
5. Capacity of the incinerator is very insufficient for its purpose.
6. Distance to the nearest habitable building from the pit and/or incinerator: 15m (pit); 40m (burner)

Usage

1. Proportion of waste sorted and placed in correct containers: 50%
2. Proportion of collected waste safely transported to the disposal point: 50%
3. Proportion of collected waste safely disposed of: 50%

D. Waste management at medical centres

Kala camp, Zambia

19/03/01

P. Harvey

Location of assessment:..... Date:..... Assessor:.....

Data	Collected data	B	Range				M	C
			10	7	4	1		
Technical appropriateness	Technically basic	7	inappropriate	technically basic	appropriate	very appropriate	0.33	2.3
Potential health hazard	Open pit, no gloves incineration inefficient	7	major hazard	basic protection	minimal hazard	no hazard	0.33	2.3
Sustainability of facilities	1 month	7	None	1 month	6 months	>1 year	0.33	2.3
No. of beds* per set of segregated containers	20	1	None	40 beds/ 1 set	30 beds/ 1 set	20 beds/ 1 set	0.2	0.2
Average one- way distance to containers	<5m	1	>20m	20m	10m	<5m	0.2	0.2
Volume of transport for segregated waste	Insufficient	7	None	Insufficient	Sufficient	Ideal	0.2	1.4
Original pit volume per bed* AND/OR	700/bed	5	None	400/bed	800/bed	>1200/bed	0.2/ 0.1	0.5
Capacity of incinerator	Very insufficient	10	Very insufficient	Insufficient	Sufficient	Ideal	0.2/ 0.1	1.0
Distance of incinerator from nearest habitable building AND/OR	40m	1	0m	5m	15m	>30m	0.2/ 0.1	0.1

continued

D. Waste management at medical centres

.... continued

Data	Collected data	B	Range				M	C
			10	7	4	1		
Distance of pit from nearest habitable building	15m	10	<25m	50m	75m	>100m	0.2/ 0.1	1.0
% of waste appropriately collected and sorted	50%	7	None	50%	75%	>95%	0.33	2.3
% of collected waste safely transported	50%	7	None	50%	75%	>95%	0.33	2.3
% of collected waste safely disposed	30%	8	None	50%	75%	>95%	0.33	2.7
Total								18.7

*Where medical centres have no beds, 2 outpatients can be taken to be equivalent to 1 bed.

EMERGENCY SANITATION

Checklist E: Disposal of dead bodies

March 2001

General description

Burial site is 500m x 500m and approximately 250m from nearest dwelling. Community organises grave digging and transportation of bodies; and MSF/World Vision provide coffins.

In general, satisfactory facilities and procedures are in place for the burial of the dead, although there is a lack of site management at the cemetery. No cremation occurs.

Quality

1. Facilities are technically appropriate
2. Potential hazards for disease transmission: none.
3. Current facilities are socially and culturally acceptable.
4. Current facilities can continue to be used for several years.

Quantity

1. Space available for burial sites: 0.25m² per 10,000 population
2. Distance to burial or cremation sites from the nearest habitable building: 250m
3. Proportion of bodies properly disposed of in an appropriate time: 100%

Usage

1. Proportion of the affected population with access to and willing to use the designated facilities: 100%

E. Disposal of dead bodies

Location of assessment:..... **Kala camp., Zambia** Date:..... **19/03/01** Assessor:..... **P. Harvey**.....

This table should be completed for each of the following as appropriate (underline or circle the relevant):

E.1 Burial E.2 Cremation at Domestic/dwelling or Medical centres

Data	Collected data	B	Range 10	7			4			1			M	C
Technical appropriateness	Gen. OK poor site management	4	inappropriate	technically basic	appropriate	very appropriate	0.25							1.0
Social and cultural acceptability	Very acceptable	2	very unacceptable	unacceptable	acceptable	very acceptable	0.25							0.5
Potential health hazard	Very minimal	1	major hazard	basic protection	minimal hazard	no hazard	0.25							0.25
Sustainability of facilities	>1 year	1	None	1 month	6 months	>1 year	0.25							0.25
Sites available for burial OR	>15000m³ /10,000	1	None	500m ² / 10,000	1000m ² /10,000	1500m ² /10,000	0.330R							0.3
Availability of fuel for cremation			None	basic supply	adequate	plentiful	0.33							
One-way distance to burial/ cremation sites from nearest habitable building	250m	5	<100m	100m	300m	500m	0.33							1.7
Collection and storage of dead bodies before decomposition	100%	1	None	50%	75%	100%	0.33							0.3
% of population with access and willing to use designated facilities	100%	1	None	50%	75%	>95%	1.0							1.0
Total													5.4	

Checklist F: Wastewater management

March 2001

General description

In general, wastewater management at the various waterpoints throughout the camp is satisfactory. Soak-pits have been constructed at all points and these are generally appropriately designed and able to cope with the volume of wastewater produced. There is potential for some covered pits to become mosquito breeding sites, however, because of open entrances and lack of gravel infilling.

This assessment has assumed that current interventions will be completed promptly and hence associated problems have not been covered by the assessment. These include unfinished and uncovered soak-pits which currently accommodate mosquito larvae populations. Implementation of planned interventions has already commenced and should be appropriate in preventing recurrence of these problems.

Quality

1. Proportion of facilities technically appropriate for their current use at all times of year: 75%
2. Breeding sites for mosquitoes in soakpits and near one waterpoint.
3. Proportion of facilities adequately maintained and managed: 75%

Quantity

1. Proportion of facilities that have been provided with a functional wastewater disposal system: 100%

Usage

1. Proportion of the total wastewater generated disposed of to appropriate designated locations: 90%

F. Wastewater management

Location of assessment:..... **Kala camp, Zambia**..... Date:..... **19/03/01**..... Assessor:..... **P. Harvey**.....

This table should be completed for each of the following as appropriate (underline or circle the relevant):

Domestic/dwelling areas Markets Feeding centres Medical centres Schools

Data	Collected data	B	Range 10	7			4		1		M	C
% of facilities technically appropriate to current purpose	75%	4	None	50%	75%	100%				0.33	1.3	
Potential health hazard	Mosquitoes breeding	8	major hazard	basic protection	minimal hazard	no hazard				0.33	2.7	
% of wastewater facilities which are adequately maintained and managed	75%	4	None	50%	75%	100%				0.33	1.3	
% of facilities with functional wastewater disposal systems	90%	2	None	50%	75%	100%				1.0	2.0	
% of wastewater disposed of in appropriate designated sites	90%	2	None	50%	75%	>95%				1.0	2.0	
Total											9.3	

Checklist G: Hygiene promotion

May 2001

Note: The hygiene promotion programme was not assessed in March since this was then at the trial stage only. The need for various hygiene promotion interventions was recognised and a full programme was initiated soon after. The checklist and table below were completed in May 2001 to provide an example of how these are used.

General description

Hygiene promoters have been recruited from the affected community to work for the health information and hygiene promotion teams. They have received minimal training in hygiene promotion so far. Basic messages concerning food hygiene, handwashing and water storage have been delivered through house-to-house visits, but little focus has been given to excreta disposal or solid waste management. Currently training and supervision is being conducted by the health team alone and there is no collaboration with the sanitation team; consequently the activities of the team are biased towards following up medical cases rather than hygiene promotion.

Quality

1. Proportion of facilitators from the same social and ethnic background as the affected population: 100%
2. Proportion of facilitators which has received appropriate training: 30%
3. Proportion of the messages being promoted accurate, appropriate to the target audiences and completely cover the topic: 30%
4. Proportion of methods being used to disseminate messages compatible with socio-cultural aspects of the population: 50%

Quantity

1. Number of facilitators per thousand affected people: 1.25
2. Proportion of affected area that has been targeted for hygiene promotion activities: 75%
3. Proportion of relevant sanitation sectors covered by these Guidelines which are being targeted by the promotion programme: 50%

Usage

1. Proportion of the affected population which has received, understood and remembered the messages: 30%
2. Proportion of the population that has put hygiene promotion messages into practice: 20%
3. Proportion of all messages delivered that has been implemented by the population: 30%

G. Hygiene promotion

Location of assessment: **Kala camp, Zambia** Date: **17/05/01** Assessor: **P. Harvey**
 This table should be completed for each of the following as appropriate (underline or circle the relevant):

Domestic/dwelling areas Markets Feeding centres Medical centres Schools

Data	Collected data	B	Range				M	C
			10	7	4	1		
% of trained facilitators from the same social background	100%	1	None	50%	75%	100%	0.33	0.3
% of messages accurate, appropriate and complete	30%	8	None	50%	75%	100%	0.33	2.7
% of messages delivered in a way that is socio-culturally acceptable	50%	7	None	50%	75%	100%	0.33	2.3
Number of facilitators per thousand people	1/800	3	None	1	2	>2	0.33	1.0
% area covered by campaign	75%	4	None	50%	75%	100%	0.33	1.3
% of relevant sanitation sectors for which appropriate use is promoted	50%	7	None	50%	75%	100%	0.33	2.3

continued ...

G. Hygiene promotion

.... continued

Data	Collected data	B	Range 10	M			C
				7	4	1	
% of population receiving, understanding and remembering promotional messages	30%	7	None	30%	50%	> 75%	2.3
% of population putting messages into practice	20%	8	None	30%	50%	> 75%	2.7
% of messages delivered implemented	30%	7	None	30%	50%	> 75%	2.3
Total							17.3

CASE STUDY

Priority setting results

Location of assessment: **Kala camp, Zambia**. Date: **19/03/01**. Assessor: **P. Harvey**.

Table C3. Sector analysis results								
Sector	Area					Sector average	Priority sector(s)	
	D A	Mkt	R C	M C	Sch			
B. Excreta disposal								
B.1 Single/shared	4.8					6.8	7.0	Low
B.1 Domestic communal	8.5					8.5		
B.1 Special groups	5.3					5.3		
B.2 Communal latrines		-	15.0	6.3	6.8	9.4		
C. Solid waste management								
C.1 Pit disposal	15.6					15.6	19.4	High
C.2 Bin disposal	-	-	-		-	-		
C.3 Communal disposal		28.0	18.2		-	23.1		
D. Waste management at medical centres								
D.				18.7		18.7	18.7	High
E. Disposal of dead bodies								
E.1 Burial	5.4			-		5.4	5.4	Low
E.2 Cremation	-			-		-		
F. Wastewater management								
F.	9.3		-	-		9.3	9.3	Low
G. Hygiene promotion								
G.	-	-	-	-	-		-	
Area average	8.2	28.0	16.6	12.5	6.8	12.0	Site average	
Priority area(s)	Low	V. High	High	Medium	Low			

D A – Dwelling areas; Mkt – Markets; R C – Reception centres; M C – Medical centres; Sch - Schools

EMERGENCY SANITATION

Table C4. Summary assessment table (19/03/01)

Sector	Score	Priority
Excreta disposal	7.0	
Solid waste management	19.4	High
Waste management at medical centres	18.7	High
Disposal of dead bodies	5.4	
Wastewater management	9.3	
Hygiene promotion	N/A	Very high
AVERAGE site score	12.0	Short-term acceptable level

Summary

In general there is a satisfactory standard of sanitation facilities, services and practices in the camp. According to medical staff the overall health status in the camp is acceptable, with malaria the most prevalent disease. The camp average score is slightly higher than the long-term acceptable level, primarily due to problems concerning solid waste and medical waste management. There is also a need for an effective hygiene promotion programme.

Recommendations

Based on this analysis the following priority sectors were identified: solid waste management, waste management at the medical centre and hygiene promotion. An outline programme design and plan of action were then produced.

C3. Outline programme design

The outline programme design was produced in March 2001, a simplified version is produced below.

The outline programme design for all relevant sectors is presented in Table C5. This includes key activities, a time-frame and responsible bodies for co-ordination of activities (the facilitator). Immediate actions should be implemented within one month.

CASE STUDY

Table C5. Sanitation plan of action

Area/time frame	Action	Facilitator
Solid waste management		
MARKET Immediate	<ul style="list-style-type: none"> ■ Excavate pit (1.5m x 2m x 2m) approx. 75m from market along service strip. ■ Recruit workers to clean market, and transport and dispose of waste. ■ Provide overalls, boots, gloves, brooms, spades and wheelbarrows. ■ Provide at least four bins at market. ■ Fill and cover pits at market. 	<ul style="list-style-type: none"> ■ World Vision
MARKET Long-term	<ul style="list-style-type: none"> ■ Workers to be paid for one month by World Vision and then from contributions from stall-holders. ■ Pit to be properly managed by regular infilling and combustion of waste when appropriate. ■ New pit to be constructed alongside, once pit is full. 	<ul style="list-style-type: none"> ■ World Vision ■ Market committee
RECEPTION CENTRE Immediate	<ul style="list-style-type: none"> ■ Provide bins at reception centre. ■ Train World Vision workers in appropriate collection and disposal. 	<ul style="list-style-type: none"> ■ World Vision
RECEPTION CENTRE Long-term	<ul style="list-style-type: none"> ■ Construct new covered pit approx. 100m from dwellings to be used by workers only ■ Close existing pit. 	<ul style="list-style-type: none"> ■ World Vision
DWELLING AREAS Immediate	<ul style="list-style-type: none"> ■ Complete communal waste pits (Blocks A-F) and pits for vulnerable households. ■ Train hygiene promoters. ■ Hygiene team to promote respective appropriate use and management of communal pits (A-F) and family pits. 	<ul style="list-style-type: none"> ■ MSF Sanitation and Hygiene promotion team
DWELLING AREAS Long-term	<ul style="list-style-type: none"> ■ Monitor use of communal waste pits (Blocks A-F) and compare with effectiveness of family garbage pit programme. ■ Decide on most appropriate long-term solution and continue relevant programme. 	<ul style="list-style-type: none"> ■ MSF Hygiene promotion team

Activity	Week starting							
	26/3	2/4	9/4	16/4	23/4	30/4	7/5	14/5
Recruit staff		World Vision						
Provide tools			World Vision					
Provide bins			World Vision					
Excavate pit			World Vision					
Fill old pits			World Vision					
Collect levies and pay staff			Market committee					

EMERGENCY SANITATION

Area/time frame	Action	Facilitator
Waste management at medical centres		
Immediate	<ul style="list-style-type: none"> ■ Provide uniform and labelled plastic containers with lids for medical waste. ■ Provide uniform and labelled plastic bins for general waste. ■ Collect small plastic medicine containers, glue lids on, make slots, and label for disposal of sharps. ■ Provide uniform and labelled plastic bins for disposal of glassware. ■ Fill existing pit near health post and dig new pit with cover approx. 50m from health post and OPD. ■ Construct sealed sharps pit with restrictive entrance for disposal of sharps containers and glassware only. ■ Dispose of existing sharps containers in pit. ■ Locate burner next to general pit and use for medical waste (excluding sharps) only. ■ Train all health staff in new procedures ■ Train cleaning staff in importance of collection, transportation and disposal procedures. 	<ul style="list-style-type: none"> ■ MSF Sanitation and Health teams
Long-term	<ul style="list-style-type: none"> ■ Monitor use and seal and replace pit for general waste and pit for sharps when required. ■ Monitor and manage use of placenta burial ground to ensure adequate burial and systematic use of area. ■ Monitor consistency of and advise on waste management procedures at all medical facilities (IPD, OPD and CTC). 	<ul style="list-style-type: none"> ■ MSF Sanitation team

Activity	Week starting							
	26/3	2/4	9/4	16/4	23/4	30/4	7/5	14/5
Excavate general waste pit		MSF Sanitation						
Construct sharps pit		MSF Sanitation						
Install burner		MSF Sanitation						
Fill and cover old pit		MSF Sanitation						
Train staff in final disposal			MSF Sanitation					
Provide bins and containers				MSF Logistics/ Health				
Train health and cleaning staff					MSF Health			
Monitor systems			MSF Sanitation					

CASE STUDY

Area/time frame		Facilitator
Hygiene promotion		
Immediate	<p>Train hygiene promoters in following areas:</p> <ul style="list-style-type: none"> ■ handwashing before food preparation and after defecation to prevent disease transmission; ■ safe water collection, storage and use to prevent disease transmission; ■ importance and design of latrines for safe excreta disposal; ■ importance of cleanliness of environment and solid waste management; and ■ prevention of malaria through appropriate waste/rain water management, and other preventative measures. <p>Promotional methods to include:</p> <ul style="list-style-type: none"> ■ House to house visits ■ School visits ■ Poster campaigns 	<ul style="list-style-type: none"> ■ MSF Sanitation and Hygiene promotion team
Long-term	<p>Hygiene promoters to focus on following activities:</p> <ul style="list-style-type: none"> ■ Basic hygiene education (covering above areas) ■ School visits for basic hygiene education and to address problems of lack of handwashing facilities at schools ■ Promotion of shallow family garbage pits, sweeping and covering with soil, composting of organic waste on vegetable plots ■ Offering choice of family latrines - refugees to dig pits and construct superstructure, MSF to provide technical advice (through hygiene team) and latrine slab (once work completed) ■ Provision of tools and cleaning materials to section leaders ■ Checking and promoting cleanliness of communal and family latrines ■ Monitoring use of communal and family pits 	<ul style="list-style-type: none"> ■ MSF Hygiene promotion team

Activity	Week starting							
	26/3	2/4	9/4	16/4	23/4	30/4	7/5	14/5
Train hygiene promoters			<i>MSF Sanitation</i>					
Provide tools, etc.								
House visits								
Poster campaign								
School visits								
Monitor programme								
Monitor practice								

C4. Detailed programme design

Note: The detailed programme design was then produced. The example below considers the hygiene promotion programme only.

The detailed programme design has been produced through consultation with key stakeholders. This was achieved through focus group discussions with community (section) leaders, women's groups and the market committee.

A logical framework for the hygiene promotion programme has been produced in Table C6.

Table C6. Logical framework: hygiene promotion			
Narrative summary	Measurable indicators	Means of verification	Important assumptions
<p>Goal: (F1): Improve and sustain the health and well-being of the affected population at Kala refugee camp.</p>	<p>(F1): Crude mortality rate Crude morbidity rates: malaria; diarrhoea; dysentery; cholera; scabies</p>	<p>(F1): Monitoring reports and records from MSF medical team</p>	<p>(F1): (Goal to super goal)</p>
<p>Purpose: Improve hygiene practice, understanding and sanitation facilities among the affected population</p>	<p>Improved hygiene behaviour and awareness of hygiene and sanitation</p> <p>issuesImproved access to and use of appropriate sanitation facilities by affected population</p> <p>Increased community involvement in sanitation activities</p> <p>Improved construction, operation and maintenance of sanitation facilities following promotion campaigns</p> <p>Hygiene promotion campaigns directed at all groups within the camp, especially the vulnerable</p> <p>Hygiene promotion programme active in all areas of the camp</p>	<p>1.1 Feedback from hygiene promoters (notebooks), from MSF sanitation and health teams and from project monitoring and evaluation</p> <p>1.2 Feedback from affected community through interview and discussion</p>	<p>(Purpose to goal)</p> <ol style="list-style-type: none"> 1. Community is receptive to programme and staff 2. Community takes a proactive role in improving and maintaining facilities and are willing to organise themselves 3. Poor and vulnerable groups' demands are identified through appropriate participatory techniques

CASE STUDY

Table C6. continued			
<i>Narrative summary</i>	<i>Measurable indicators</i>	<i>Means of verification</i>	<i>Important assumptions</i>
<p>Outputs:</p> <ol style="list-style-type: none"> 1. All households visited by hygiene promoters within one month 2. All section leaders to have shovel, pick and hoe, and five buckets per street within two weeks 3. One hygiene promoter per eight hundred people and one supervisor recruited from refugee population 4. All hygiene promoters trained and able to demonstrate good understanding of key issues involved 5. Hand-washing facilities at schools 6. Increased coverage of appropriate family waste pits and latrines 7. Increased cleanliness of domestic environment 		<ol style="list-style-type: none"> 1.1 Feedback from hygiene promoters, from MSF sanitation and health teams and from project supervision, monitoring and evaluation 1.2 Feedback from community members and section leaders 1.3 Logistics records for tools and materials 	<p>(Outputs to purpose)</p> <ol style="list-style-type: none"> 1. Hygiene promoters are willing and able to communicate effectively with all members of community 2. Hygiene promoters receptive to training
<p>Activities:</p> <ol style="list-style-type: none"> 1. Recruitment of hygiene promoters and supervisor 2. Training of hygiene promoters in appropriate promotional messages and methods 3. School visits for basic hygiene education and to address problems of lack of handwashing facilities at schools 4. Home visits to promote good hygiene practice and family garbage pits, and to explain family latrine option and give technical advice 5. Provision of tools and cleaning materials to section leaders 6. Checking and promoting cleanliness of communal and family latrines 7. Monitoring use of communal and family waste pits 		<ol style="list-style-type: none"> 1.1 Feedback from hygiene promoters, from MSF sanitation and health teams and from project supervision, monitoring and evaluation 1.2 Feedback from affected community through interview and discussion 1.3 Logistics records for tools and materials 	<ol style="list-style-type: none"> 1. MSF watsan and health staff are willing to take a more multi-disciplinary and flexible approach to sanitation and health programme 2. Home visit team are willing to give increased emphasis to hygiene activities 3. Supervisor willing and able to take on increased responsibility
<p>Inputs:</p> <ol style="list-style-type: none"> 1. Tools 2. Notebooks and pens 3. Buckets 4. Staff salaries 		<ol style="list-style-type: none"> 1.1 Logistics records for tools and materials 1.2 Financial records 	<p>(Inputs to activities)</p> <ol style="list-style-type: none"> 1. Tools and buckets are available and can be procured rapidly

EMERGENCY SANITATION

Budget

A budget summary has been produced for the hygiene promotion programme over the next *six months* in Table C7 below.

Table C7. Outline budget – hygiene promotion				
Item no.	Item	Unit cost (US\$)	Quantity	Total cost (US\$)
1.	Shovel	12.5	120	1,500
2.	Pick-axe	15.0	120	1,800
3.	Hoe	10.0	120	1,200
4.	Bucket	3.00	500	1,500
5.	Pen and notebook	1.5	50	75
6.	Sign production	1.5	50	75
7.	32 x Hygiene promoter (per day)	32.0	120	3,840
8.	1 x Hygiene supervisor (per day)	2.5	120	300
	<i>Sub-total</i>			10,290
	Contingency line (15%)			1,544
	Total cost			11,834

C5. Implementation management

Table C8 shows a milestones implementation table for the hygiene promotion programme, this was completed by the project team at the end of May 2001. The milestones are linked to the outputs in the logical framework.

Project output: Improved hygiene practice, use and maintenance of excreta disposal and solid waste management facilities among the affected population

Table C8. Hygiene promotion milestones			
Selected milestones	Who	When	Current status and comments
One hygiene promoter per eight hundred people and one supervisor recruited from refugee population	MSF health and sanitation staff	26/03	Recruitment process successfully completed on time(target achieved)
All hygiene promoters trained and able to demonstrate good understanding of key issues involved	MSF health and sanitation staff	09/04	Training limited so far but on-going (amended date: 11/06)
All section leaders to have shovel, pick and hoe, and five buckets per street	MSF logistics and hygiene promotion team	16/04	Delays due to logistical procedures – awaiting approval (amended date: 04/06)
All households visited by hygiene promoters to promote good hygiene practice and family garbage pits, and to explain family latrine option and give technical advice	Hygiene promotion team	07/05	Approximately 75% of households visited so far (amended date: 15/06)
All school classes to have received basic hygiene education	Hygiene promotion team and teachers	07/05	Only 50% of school classes so far due to difficulties in co-ordination with teachers (amended date: 04/06)
All schools to have handwashing facilities	Hygiene promotion and water supply teams	14/05	No action has been undertaken due to delays by water team (amended date: 18/06)
All latrines to be maintained and kept clean	Hygiene promotion team and community	28/05	All domestic latrines well-maintained and cleaned by community
All households to have access to appropriate communal or family waste pit	Hygiene promotion team and community	28/05	Approximately 75% of households have access (amended date: 11/06)

C6. Monitoring

Several monitoring exercises were conducted in May 2001 using checklist analysis, SWOT analysis and the monitoring framework. The results of these are presented below and a simplified situation report has also been reproduced.

Checklist analysis

A repeat rapid assessment was carried out in May 2001 two months after the initial assessment. This was designed to act as a monitoring tool to quantify any change in the sanitation service provision and the overall health of the population during this two-month period.

The scores obtained for Kala Refugee Camp during the initial visit in March 2001 and the updated scores in May 2001 are presented in Table C9.

Sector	Score 24.03.01	Score 22.05.1	Comments
Excreta disposal	7.4	7.1	Unchanged acceptable level
Solid waste management	19.4	13.2	General improvement but increased intervention required
Waste management at medical centres	18.5	5.6	Huge improvement to long-term acceptable level
Disposal of dead bodies	5.4	4.6	Unchanged acceptable level
Wastewater management	9.3	7.3	Unchanged acceptable level
Hygiene promotion	N/A	17.3	Satisfactory initial stage but improvement required
AVERAGE camp score	12.0	9.2	Overall improvement from short to long-term acceptable level

Brief descriptions of the new situation for each sector are provided below.

Excreta disposal (7.4→7.1)

The overall level of service for excreta disposal has not changed greatly since March and facilities and practices remain acceptable for long-term intervention. The average sector score has reduced slightly due to improved quality and quantity of latrines at the medical centre.

There has been a slight increase in the number of completed family latrines and the quality of these is generally good. In addition the MSF sanitation team has marked out proposed family

CASE STUDY

latrine sites in several blocks. The design and construction of concrete latrine slabs has been considerably improved with decreased thickness (approx. 6cm), footrest positions and sloped surface.

Some latrines at the reception centre are currently full, whilst the lack of latrines at the distribution centre was observed to be posing some problems on distribution days.

Solid waste management (19.4→13.2)

Solid waste management at Kala camp has still failed to achieve the recommended long-term minimum objectives, although the overall situation has improved somewhat. Management systems at the market and reception centre have been initiated but these are still largely ineffective in tackling potential hazards, and these sites remain the main problem areas. Tools and clothing have been provided by World Vision and bins were provided at both locations but were removed in recent food riots and have not been returned or replaced.

In general, there is an increased coverage of family garbage pits and in many of these the waste is covered with soil or ash. Waste is now drying and decomposing faster in the uncovered pits due to the changed climatic conditions.

Communal solid waste pits have now been constructed (Blocks A-F only) but are not being used. Pits are currently intercepting the water table and are acting as breeding grounds for large populations of mosquitoes. Community members were observed drawing water from pits for laundry or construction use. These pits were assessed separately and obtained a score of 16.0 (compared to 9.4 for the family pits).

Waste management at medical centres (18.5→5.6)

Recommended long-term objectives for waste management at medical centres have now been achieved, and this sector has seen the greatest improvement in service provision. Segregation of different types of waste at source is well organised, signs have been provided and staff have now been trained effectively, although protective clothing is limited. Coloured plastic bins are used to segregate medical (pathological) waste, glassware and general waste. Sealed medicine containers are used for the disposal of sharps, although these have not been provided in some of the wards.

The system for transportation of segregated waste is safe and efficient. A covered pit has been constructed for general waste and is situated at an acceptable distance from the health post (approx. 75m). The burner has been relocated (approx. 100m downwind from health centre) and is used for the disposal of medical and paper wastes; the ash is deposited in a sealed pit. A sharps pit has been constructed alongside and is used for the disposal of sharps containers and glassware. Both burner and sharps pit are enclosed and secure.

Placentas are still disposed of in the burial ground where there is no proper management system in place.

Disposal of dead bodies (5.4→4.6)

Satisfactory facilities and procedures are in place for burial of the dead, and site management at the cemetery is much improved, leading to improved score.

EMERGENCY SANITATION

Wastewater management (9.3→7.3)

In general, wastewater management at the various waterpoints throughout the camp is satisfactory. Soak-pits have been improved and are able to cope with the volume of wastewater produced. There was no evidence of mosquito breeding in soak-pits.

Use of natural site drainage has been adopted at several waterpoints and this seems to be effective. New tapstand aprons are generally well designed and constructed, although the apron width is slightly narrow leading to large quantities of splashed water at one tapstand.

Hygiene promotion (No score→17.3)

The hygiene promotion programme was not assessed in March since this was then at the trial stage only. The hygiene promotion programme has now been running for two months and has been implemented by the health home-visit team. The current score indicates that the immediate recommended minimum objectives have been achieved but that the short-term objectives have not.

Team members have been trained in basic hygiene education but training has been limited so far with little attention to sanitation facilities. There is a pronounced bias among the team in favour of health activities (e.g. follow up of medical cases) over hygiene. Home-visitors claim that the combined workload is not too great but that further training is needed.

The programme currently focuses on home visits although some school hygiene education sessions have been conducted and informal meetings are held. At present no signs or posters have been produced and monitoring of sanitation facilities appears to be minimal. Provision of tools and cleaning materials is reported by section leaders to be inadequate.

The team has a Congolese supervisor who appears to be highly able and motivated.

Average camp score (12.0→9.2)

In general there is a satisfactory standard of sanitation facilities, services and practices and an acceptable overall health status in the camp (malaria incidence reduced slightly). The camp average score has improved significantly and is now within the long-term acceptable level. Problems concerning solid waste management remain and there is a need for a more effective hygiene promotion programme.

CASE STUDY

SWOT Analysis

The overall sanitation programme was then analysed in terms of SWOT (Strengths, Weaknesses, Opportunities and Threats). This was conducted with a group of agency staff and community leaders and was designed to identify the positive and negative elements of the programme to date, in order to improve the effectiveness of future action plans. The results of this exercise are presented in Table C10.

Table C10. SWOT analysis results	
Strengths	<ul style="list-style-type: none"> Strong labour force and good supervision for technical assignments High latrine coverage High production of good quality latrine slabs Much improved system for medical waste management Efficient wastewater management systems Strong links between sanitation and health teams Flexible and strong organisational set-up
Weaknesses	<ul style="list-style-type: none"> Lack of monitoring of systems once implemented (e.g. medical waste, market waste) Lack of delegation of duties to Congolese counterparts Inappropriate communal solid waste pits Hygiene promotion activities sidelined by health and watsan teams
Opportunities	<ul style="list-style-type: none"> Community willingness to participate in sanitation activities Solid base for effective hygiene promotion team Potential for greater collaboration between MSF, World Vision and UNHCR Good communication lines established with community leaders Foundation for solid waste management systems in place at market and reception Hygiene promotion can become heart of sanitation programme
Threats	<ul style="list-style-type: none"> Lack of collaboration between implementing agencies Lack of monitoring of on-going activities and systems Inadequate change-over of key agency staff Hygiene promotion sidelined due to active water supply and health programmes Creating a cycle of dependence and expectation among affected population
SWOT summary	<p>In general, the hardware components of the sanitation programme are very strong while the software aspects remain much weaker with less emphasis given to these by programme staff. However, the institutional and organisational framework is in place to facilitate a smooth change in emphasis. Monitoring of programme activities and strong co-ordination of activities is essential. The affected population is keen to be involved and may be given more responsibility where appropriate.</p>

EMERGENCY SANITATION

Monitoring framework

A monitoring framework was also completed and is shown in Table C11.

Table C11. Monitoring framework	
Implementation component	Recorded information
Staff	<p>Staff recruitment currently on target. Training of hygiene promoters on-going but requires greater input; and practical training has been provided for construction supervisors. Increased proportion of Congolese staff at higher skill levels but increased delegation of responsibilities to these staff is required. Supervision structure is in place with logisticians and team captains but no formal staff appraisal procedures in place. Generally staff are working efficiently and effectively although increased training is needed. Some conflict has been reported between Congolese staff of different tribal groups (concerning differential treatment by supervisors) and between Zambian and Congolese staff – MSF is working to resolve this through promotion of the agency's humanitarian principles.</p>
Resources	<p>In general, appropriate resources are procured and used in line with programme plans. Logistics request forms and procurement forms operate effectively and external orders are sent to Lusaka via email. Regular feedback from Lusaka logistics is provided via email. The only additional resources possibly required are SanPlat moulds (to reduce cement consumption by using smaller slabs) – currently under investigation. Local materials are used where possible (unless unavailable or very expensive). Early cutting of timber has led to considerable deforestation in the immediate vicinity of the camp; now timber is only taken from site designated by the Ministry of Agriculture which is approximately 5km from camp.</p>
Finances	<p>No budget outline or breakdown has been presented to field staff and hence budget lines are unclear at field-level. The programme expenditure currently exceeds the budget and there is a lack of budget control.</p>
Time	<p>Currently no feedback is provided to the field from the finance department. The hygiene promotion programme is currently behind schedule due to lack of co-ordination and unclear responsibilities; and the heavy workloads of staff and change in personnel have contributed to this. The procurement of tools for the family latrine and waste pit programmes has also been delayed due to budget constraints but it is hoped this will be rectified very soon. Day-to-day time management is generally satisfactory although greater delegation of duties by senior staff will provide a more efficient system.</p>
Outputs	<p>Output targets are being met for facility provision for excreta disposal, solid waste management, medical centre waste management and wastewater management. Hygiene promotion outputs currently behind targets. Morbidity and mortality rates are fairly stable with low incidence of sanitation-related diseases. The equity of programme benefits is very good due to regular consultation with hygiene home-visit team and community leaders; and there is a strong focus on vulnerable households. Outputs are generally sustainable for the long-term intervention level although increased monitoring activities are required. Current unaddressed needs identified include insufficient soap and water storage containers for handwashing (for domestic areas and at schools).</p>

CASE STUDY

Table C11. continued...	
	<p>Unforeseen side-effects include groundwater in communal waste pits leading to mosquito breeding and use of inappropriate water. Several hand-dug wells have also been constructed by community members in the newer areas of the camp (supposedly for construction use only) – this issue should be addressed immediately.</p>
Community	<p>The community is currently actively involved in the design, construction and O&M of family latrines and waste pits, but have negligible input into programme planning. Facilities are generally used and maintained appropriately, although squat-hole covers are often removed and the removal of plastic sheeting from some communal latrines has also occurred – this will be replaced with mud and grass in future. Since the hygiene promotion programme is in the early stages only it has had only a small impact on hygiene practice but this is gradually improving. There are currently no substantial capacity building activities in place.</p>
Information	<p>Monthly situation reports are produced in the field and sent to Lusaka. Programme plans are currently produced at irregular intervals for large-scale interventions only. Community meetings, inter-agency meetings (including local authority representation) and MSF staff meetings are conducted on a weekly basis. The hygiene promotion programme is beginning to act as an effective link between the medical and watsan teams, and provides good transfer of information on many community issues. Technical information support is currently satisfactory.</p>

Situation report

Based on the monitoring framework above, an example situation report for the month of April is produced in Table C12.

EMERGENCY SANITATION

Table C12. Situation report

Location	Kala camp, Zambia
Agency	Médecins Sans Frontières, Holland
Reporting period	April 2001
Name of reporter(s)	Joseph Ng'ambi; Peter Harvey
Position of reporter(s)	Watsan engineer; Researcher
Overall situation summary (security, population, climate, etc.)	Some protests concerning food rations but now generally stable situation, very few new arrivals, dry season just begun
Staff issues (new staff, contracts, salaries, etc.)	Watsan engineer due to leave within next two months, heavy workload on water supply issues; labour force stable at present
Goods received in reporting period	Bins and containers for segregation of medical waste; large aggregate for soakpits
Logistics orders outstanding (order dates)	Cleaning materials (28/4); tools (28/4)
Expenditure for reporting period	US\$1,000 (excluding salary commitments)
Financial requirements for next reporting period	Continued salary commitments only
Time constraints (reasons for delays, etc.)	Some family latrines not completed due to lack of dry grass for roofs; lack of solid waste pits due to limited supply of tools
Activities undertaken during reporting period	Sharps pit and burner constructed; new medical waste system implemented; soakpits and drainage channels completed at all waterpoints; hygiene promoters recruited; initial training of hygiene promoters undertaken
Changes made to existing plans (including reasons)	Hygiene promotion programme to run in conjunction with health home-visit programme; World Vision to maintain responsibility for solid waste at the market
Tasks outstanding / forthcoming activities	Train hygiene promoters concerning sanitation facilities, focus on solid waste and excreta disposal; placenta pit to be constructed; wastewater drainage channels to be completed
Community issues	Community representatives expressed frustration over lack of tools and cleaning materials; Market Committee currently unable to take on responsibility of paying waste workers
Information details (meetings held, data received)	Weekly meetings with community leaders; weekly meetings with Market Committee, technical manual received from WEDC
Information requested	None
Other agencies / stakeholders (news and activities)	UNHCR Watsan visit and new co-ordinator

C7. Evaluation

An interim evaluation of the sanitation programme was carried out in August 2001; a summarised report has been reproduced below.

Summary

Kala camp was set up in August 2000 for Congolese refugees fleeing civil strife in the Democratic Republic of Congo (DRC). The current population of the camp is 19,000 and the average family size is four. The population is currently steadily increasing by approximately 1000 people per week. World Vision is responsible for camp management and MSF Holland is responsible for health, water supply and sanitation, although they intend to end their programme by the end of 2001. The local government provides police for camp security and UNHCR co-ordinates the relief effort.

The purpose of this evaluation is to provide an interim report on the current status of the sanitation programme with a view to the likely hand-over of the programme to a different implementing agency at the end of this year. The evaluation structure consists of brief descriptions of the programme activities, outputs and resources, followed by a completed evaluation framework to assess programme appropriateness, effectiveness and efficiency.

In general the programme is functioning in an efficient and effective manner and has produced a significant improvement in sanitation service provision at Kala camp over the past six months. The main recommendations coming out of this evaluation are to:

- develop a fully independent hygiene promotion team;
- address immediately the issue of hand-dug wells;
- instigate effective monitoring of waste management at the medical centre;
- introduce greater consultation with World Vision;
- introduce improved budget control measures; and
- begin preparation of documents for hand-over to new implementing agency

Programme justification

Due to an increased influx of Congolese refugees into Zambia during 2000 the need arose to identify and provide an appropriate site for a refugee camp. Once the site at Kala was identified and approved by the Government of Zambia, it was necessary to make the site habitable and ensure that basic services such as water supply, healthcare and sanitation were put into place. Many people among the affected population have been subjected to upheaval, poverty and poor health and the need for external humanitarian assistance was, and remains, considerable. It is for these reasons that continued intervention is required.

Activities

Programme activities to date include the provision of communal sanitation facilities for new arrivals and vulnerable groups; the management of wastewater, solid waste and excreta at public sites; and hygiene promotion for the implementation of new facilities, appropriate use and maintenance, and good hygiene practice.

There are no major constraints affecting the programme although the budget is limited. Key opportunities include increased community participation; greater collaboration with other implementing agencies; and a more effective and proactive hygiene promotion team.

EMERGENCY SANITATION

Outputs

The outputs achieved to date include:

- Communal latrines for all new arrivals and family latrines for vulnerable households constructed by MSF;
- Hygiene promotion team conducting home visits to promote implementation of family latrines and waste pits, appropriate use and maintenance of sanitation facilities, and safe hygiene practice;
- Effective waste management systems at all medical facilities;
- Effective wastewater management systems at all water distribution points; and
- Efficient operation to produce concrete latrine slabs.

Resources

Following the monitoring exercise conducted in May 2001 a professional hygiene promotion specialist was recruited nationally and has now joined the team. He will be responsible for the co-ordination of the hygiene promotion programme and related sanitation activities. So far the hygiene promotion activities have been conducted by the health information team which is also responsible for following up medical cases through home visits and other medical-related activities. As a result, hygiene promotion has been given secondary priority and the programme has not been progressing. In addition, training in hygiene promotion has not been adequate to date.

Staff employed for the construction of sanitation facilities and manufacture of latrine slabs are currently working effectively although the team may be more efficient if slightly reduced in size

Financial resources are currently adequate although the projected costs for the sanitation programme are generally quite low and hence there is little programme flexibility for high capital cost interventions. It is expected that current funds will be sufficient for the remainder of the programme.

Logistical resources are currently adequate and appropriate materials are generally available locally. Use of cement is currently fairly high and this could be reduced through the use of small plastic SanPlat moulds to produce smaller squatting slabs.

Evaluation framework

A completed evaluation framework to assess the programme is produced below (Table C13):

CASE STUDY

Table C13. Evaluation framework	
Evaluation component	Recorded information
Appropriateness	<p>The programme has been appropriate with respect to the:</p> <ul style="list-style-type: none"> ■ perceptions and needs of the affected population; ■ policies and mandate of the agency; and ■ national and international policies; <p>However, the prioritisation of needs and urgency of implementation has often been inappropriate with a tendency to focus on large-scale construction activities in place of high-impact software activities.</p>
Connectedness	<p>Local resources and capacities have been identified and built upon where possible. Currently the programme has done little to enhance community decision-making but the hygiene promotion programme has a strong focus on addressing this.</p> <p>UNHCR has been officially informed that MSF will be closing down their programme at the end of 2001, a replacement implementing partner has been identified and the hand-over is scheduled to commence next month.</p> <p>The programme outputs are generally sustainable over their design life, although lack of monitoring of systems (such as the medical waste management system) threatens this sustainability.</p>
Effectiveness	<p>The programme purpose has been successfully realised by maintaining a stable health status among the affected population and providing appropriate sanitation facilities and services.</p> <p>There have been few unforeseen side effects although the construction of inappropriate hand-dug wells has increased significantly with increased tool provision.</p> <p>In general, the programme has evolved in line with monitoring results and the shift in emphasis to hygiene promotion has been a key part of this, with the employment of a sectoral professional breaking new ground for MSF.</p> <p>The recommended minimum objectives for long-term intervention have now been satisfied for all sanitation sectors.</p>
Impact	<p>In general, the programme objectives been achieved.</p> <p>It is difficult to determine the effect of the programme on morbidity and mortality rates although the health status has remained fairly stable over the past six months, and diarrhoeal disease has decreased significantly.</p> <p>The programme has contributed to the stabilisation and empowerment of the community in that the emphasis for programme design and implementation is gradually shifting from agency to community. Unforeseen impacts include increased malaria due to mosquito breeding in communal solid waste pits close to dwellings.</p>
Coherence	<p>MSF has collaborated with implementing partners, particularly World Vision, concerning solid waste, although this has lacked coherence at times.</p> <p>There have currently been no overlaps with other humanitarian actors concerning sanitation.</p> <p>Community priorities and plans are starting to be incorporated into intervention strategies but his transformation is still slow. In general, there has been an effective information flow between stakeholders, with the exception of internal agency budget data.</p>
Coverage	<p>The extent of the programme impact on the affected population is extensive with the creation of appropriate and sanitary living conditions.</p> <p>In general, access to appropriate facilities and services has been adequate and equitable benefits have been achieved.</p>

Table C13. continued

Efficiency	<p>The ratio between outputs and inputs has been difficult to assess, primarily due to the lack of appropriate records. The lack of budget and expenditure details is a key constraint. In general terms the following observations have been made:</p> <ul style="list-style-type: none"> ■ Staff: numbers appear to be inappropriately high although steps are currently being taken to address this. ■ Resources: the use of timber has exceeded basic requirements for communal facilities at times and cement consumption is still fairly high, although reduction strategies are currently under investigation. ■ Finances: the programme has overspent in relation to the initial budget although funds are available for continued implementation. No data concerning cost-effectiveness is available at present. ■ Time: use of time is generally efficient although greater delegation of duties is essential to reduce workload on senior staff. ■ Community participation: community-based activities have been very efficient where used and there is much potential for increased activity. ■ Information: the time spent on information exchange (reports, meetings, etc.) and the actual information exchanged are generally appropriate.
-------------------	-----------------------------------------------------------------------------------------------------------------------------------------------------------------------------------------------------------------------------------------------------------------------------------------------------------------------------------------------------------------------------------------------------------------------------------------------------------------------------------------------------------------------------------------------------------------------------------------------------------------------------------------------------------------------------------------------------------------------------------------------------------------------------------------------------------------------------------------------------------------------------------------------------------------------------------------------------------------------------------------------------------------------------------------------------------------------------------------------------------------------------------------------------------------------------------------------------------------------------------------------------------------------------------------------------------------------

Conclusions

In general, the hardware components of the sanitation programme are very strong and while the software aspects remain much weaker the organisational framework is in place to facilitate a smooth change in emphasis, and this is now beginning to happen. Monitoring of programme activities and co-ordination of activities has improved but requires greater emphasis.

The sanitation programme is now well established and functioning effectively although there is still much potential for improvement in the hygiene promotion programme. To ensure a successful and sustainable conclusion to the overall programme it is essential that increased emphasis is placed on hygiene promotion.

The agency human resource base, staff motivation and team spirit are very strong and logistical support is good. Greater budget control and delegation of responsibility are required, however. Many members of the affected population are keen to be involved in programme activities and may be given more responsibility where appropriate. Community organisation and communication lines are well established and effective, and may be used more.

Recommendations

Key recommendations for this programme are as follows:

1. Recruit and train an independent hygiene promotion team

- It is recommended that the hygiene promotion team should be independent from the health home-visit team for the following reasons:
- Currently medical activities (medical cases, vaccinations, etc.) receive priority over hygiene promotion.

CASE STUDY

- The hygiene promoters need on-going intensive training, especially over the next two months, if the programme is to be effective.
- Ideally, hygiene promoters should reside in the section of the camp to which they are assigned (this is not the case with the health team).
- Hygiene promoters do not need a medical background but should simply be respected among the target population.
- Extensive promotion campaigns are required for important issues such as family sanitation facilities and hand-dug wells, and significant inputs in terms of time and training are required if these are to be successful.

2. Address issue of family sanitation facilities

The hygiene promotion programme should focus strongly on the community construction of family latrines and waste pits to ensure the sustainability of excreta disposal and solid waste management in the camp dwelling areas. In addition, on-going monitoring of facility use and maintenance should be conducted by hygiene promoters.

3. Address issue of hand-dug wells

It is essential that immediate action is taken to resolve the problem of the marked increase in the prevalence of hand-dug wells constructed by community members. Although this is primarily a water supply issue it is a side-effect of the provision of tools as part of the sanitation programme and should be addressed by the hygiene promotion team. Possible appropriate measures include:

- Hygiene promotion team to map locations and specifications (depth, water level, lining, protection etc.) of all wells within the camp to assess risks and community needs.
- Hygiene promoters to interview and educate community members regarding unsafe water quality, boiling of water and well protection measures.
- Hygiene promotion team to organise regular shock-chlorination of wells to reduce risks.
- Hygiene promotion team to mobilise community members to undertake well protection measures to increase physical safety and limit surface contamination.
- Water team to provide short-term water supply at the 'last tower' while new water supply system is completed.

4. Instigate effective monitoring of waste management at the medical centre

It is important that someone is given responsibility to monitor and co-ordinate waste management at the medical centre since this is not being done at present and some slight problems are beginning to surface.

5. Introduce greater consultation with World Vision

Increased consultation should be undertaken with World Vision regarding excreta disposal and solid waste management at the distribution centre, reception centre and market.

6. Introduce improved budget control measures

Greater budget control is required to prevent a repeat of the problem of over-spending. All field staff responsible for ordering and specifying resources should be made aware of budget constraints and provided with regular budget control reports.

7. Procure SanPlat moulds

SanPlat moulds should be procured in Lusaka and workers trained in their use to commence production of smaller, higher quality latrine slabs.

8. Close communal solid waste pits

The communal solid waste pits in Blocks A-H should be filled in and sealed before the commencement of the rainy season to avoid encouraging mosquito populations and the use of inappropriate water.

9. Begin preparation of documents for hand-over

Situation, monitoring and evaluation reports should be compiled to facilitate a smooth hand-over to the new implementing agency at the close of the programme.

Peter Harvey, WEDC, 16th August 2001

Bibliography

- Adams, John (Ed.) (1995) *Sanitation in Emergency Situations: Proceedings of an international workshop*. Oxfam: Oxford.
- Adams, John (1999) *Managing Water Supply and Sanitation in Emergencies*. Oxfam: Oxford.
- Ahmed, M. Feroze and Jahan, Hasin (2000) *Participatory Management of Low-cost Water Supply and Sanitation*. ITN-Bangladesh.
- Almedom, Astier M., Blumenthal, Ursula & Manderson, Lenore (1997) *Hygiene Evaluation Procedures; Approaches and methods for assessing water and sanitation related practices*. London School of Hygiene and Tropical Medicine (LSHTM) and International Nutrition Foundation for Developing Countries (INFDC): London.
- Appleton, Jenny and Ali, Mansoor (2000) *Healthcare or Health Risks? Risks from Healthcare Waste to the Poor*. WELL Study
- Assar, M. (1971) *Guide to sanitation in Natural disasters*. WHO: Geneva.
- Ayoade, J.O. (1988) *Tropical Hydrology and Water Resources*. Macmillan Publishers: Basingstoke & London.
- Boot, Marieke T. (1991) *Just stir Gently*. IRC: Hague, The Netherlands.
- Boot, Marieke T. and Cairncross, Sandy (1993) *Actions Speak: The study of hygiene behaviour in water and sanitation projects*. IRC: Hague, The Netherlands.
- Brandberg, Bjorn (1997) *Latrine Building: A handbook for implementation of the SanPlat system*. Intermediate Technology Publications: London.
- Cairncross, S. and Feachem, R. (1983) *Environmental Health Engineering in the Tropics: An introductory text*. John Wiley & Sons: Chichester.
- CDC (2000) *Viral Hemorrhagic Fevers: Fact Sheets*. Centres for Disease Control and Prevention: Washington D.C. (<http://www.cdc.gov>)
- Chalinder, Andrew (1994) *Good practice review 1: Water and sanitation in Emergencies*. Overseas Development Institute: London.
- Clark, D.H., Nicholls, J. & Gillespie, F. (1992) Planning for Mortuary Facilities in Mass Disasters, *Disaster Management* 4(2), pp 98-102
- Coad, A. (1992), *Managing Medical Wastes in Developing Countries* Report on a Consultation on Medical Wastes Management in Developing Countries. WHO: Geneva.
- Cooper, P.F., Job, G.D., Green, M.B. and Shutes, R.B.E. (1996) *Reed Beds and Constructed Wetlands for Wastewater Treatment*. WRC: Swindon.

EMERGENCY SANITATION

- Curtis, Valerie (1999) *Hygiene Promotion*. WELL Technical Brief. <http://www.lboro.ac.uk/well/services/tecbriefs/hygiene.htm>
- Davis, Jan and Lambert, Robert (1996) *Engineering in Emergencies: A practical guide for relief workers*. RedR / IT Publications: London.
- Feacham, Richard G. et al. (1983) *Sanitation and Disease: Health aspects of excreta and wastewater management*. World Bank: Bath, UK.
- Ferron, Suzanne; Morgan, Joy and O'Reilly, Marion (2000) *Hygiene Promotion: From relief to development*. CARE/Intermediate Technology: UK.
- Franceys, R., Pickford, J. and Reed, R. (1992) *A Guide to the Development of On-site Sanitation*. WHO: Geneva.
- Gajanayake, Stanley and Gajanayake, Jaya (1993) *Community Empowerment: A participatory training manual on community project development*. Office of International Training and Consultation, Northern Illinois University: Dekalb.
- Gosling, Louisa and Edwards, Mike (1995) *Toolkits: A practical guide to assessment, monitoring, review and evaluation*. Save the Children: London.
- Goyet, Claude d.V.d. (1999) *Stop Propagating Disaster Myths*. Pan American Health Organisation: Washington. (<http://paho.org>)
- GTZ (1988) *ZOPP in Brief: objectives-oriented project planning*. Deutsche Gesellschaft für Technische Zusammenarbeit (GTZ): Eschborn.
- Hanbury, Clare (1993) *Child-to-Child and Children Living in Camps*. The Child-to-Child Trust: London.
- Healing, T.D., Hoffman, P.N. and Young, S.E.J. (1995) The Infection Hazards of Human Cadavers. *Communicable Disease Report*. Vol 5, Review No 5.
- House, Sarah and Reed, Bob (1997) *Emergency Water Sources: Guidelines for selection and treatment*. WEDC, Loughborough University: Loughborough.
- Kalbermatten, John M. and Gunnerson, Charles G. (1985) *Appropriate Technology for Water Supply and Sanitation: A sanitation field manual*. World Bank.
- Médecins Sans Frontières (1994) *Public Health Engineering in Emergency Situation*. Médecins Sans Frontières: Paris.
- Médecins Sans Frontières (1997) *Refugee Health: An approach to emergency situations*. Médecins Sans Frontières, Macmillan Education Ltd: London and Basingstoke.
- Mukiibi, Elisba Mutyaba (1997) *A Draft Framework for Emergency Water and Sanitation Interventions*. World Vision: Milton Keynes.
- NORAD (1990) *The Logical Framework Approaches (LFA): Handbook for objectives-oriented planning*. NORAD: Oslo.
- PAHO (1993) *Manual de Manejo de Cadaveres en Situaciones de Desastre*. Organización Panamericana de la Salud: Washington.
- Pruss, A., Giroult, E. and Rushbrook, P. (Eds.) (1999) *Safe Management of Wastes from Health-care Activities*. WHO: Geneva.
- Reed, R. and Dean, P.T. (1994) Recommended methods for the disposal of sanitary wastes from temporary field medical facilities. *Disasters*, Vol 18, No 4.
- Reed, R. (2000) *Low-cost Sanitation: A postgraduate distance learning module*. WEDC, Loughborough University: Loughborough.
- Rietbergen-McCracken, J. and Narayan, D. (compiled by) (1998) *Participation and Social Assessment: Tools and techniques*. The International Bank for Reconstruction and Development / The World Bank: Washington D.C.

BIBLIOGRAPHY

- SCF(UK) (1990) *Disaster Management Guidelines*. Save the Children Fund: London.
- Smith, Mike (2001) *Wastewater Treatment: A postgraduate distance learning module*. WEDC, Loughborough University: UK.
- Smout, Ian; Samson, Kevin; Coates, Sue and Snel, Marielle (2000) *Community and Management: A postgraduate distance learning module*. WEDC, Loughbrough University: Loughborough.
- Sphere Project (1999) *Humanitarian Charter and Minimum Standards in Disaster Response*. Standing committee for Humanitarian Response (SCHR): Geneva (<http://www.sphereproject.org>)
- Svendsen, Dian Seslar; Foster, Pam and Sartorius, Rolf (1998) *Facilitation Skills: An introductory guide*. Project Concern/Social Impact: USA.
- Toole, M.J. and Waldman, R.J. (1997) *The Public Health Aspects of Complex Emergencies and Refugee Situations*. Annual Review of Public Health Vol. 18, USA.
- UNCHS (1986) *Community Participation in Low-cost Sanitation*. United Nations Centre for Human Settlements (Habitat): Nairobi.
- UNDRO (1982) *Disaster Prevention and Mitigation, Vol.8. Sanitation Aspects*. UNDRO: Geneva.
- UNHCR (2000) *Handbook for Emergencies*. UNHCR: Geneva.
- UNICEF (1998) *Happy, Healthy and Hygienic: How to set up a hygiene promotion programme*. United Nations Children's Fund: New York.
- WHO (1983) *Appropriate Technology for the Treatment of Wastewater for Small Rural Communities*. WHO: Geneva.
- WHO (1987) *Technology for Water Supply and Sanitation in Developing Countries: A report of a WHO Study Group*. (WHO technical Report Series, No. 749) WHO: Geneva.
- WHO (1993) *Guidelines for Cholera Control*. WHO: Geneva.
- WHO (1998) *PHAST Step-by-step Guide: A participatory approach for the control of diarrhoeal disease*. WHO: Geneva.
- WHO (1999) *Guidelines for Safe Disposal of Unwanted Pharmaceuticals in and after Emergencies*. WHO: Geneva.
- WHO (1999) *Public Health Consequences of Earthquakes*. Technical Briefing Note, WHO: Geneva.
- WHO (2000) *Cholera*. Fact Sheet N107, WHO: Geneva. (<http://www.who.int>)
- Wilson, K. and Harrell-Bond, B. (1990) Dealing with dying. *Refugee Participation Network (RPN)* newsletter, No. 9, August 1990: Oxford.
- Zaman, Maniza S. (1990) *African Disaster Handbook*. WHO: Geneva.

Index

A

Activity plan 192, 277
Anal cleansing 34, 60, 98
Aqua privies 84
Assessment 13 - 29, 177, 183, 217 - 220, 223 - 227, 252, 270, 328
Assessment process 13, 224

B

Base scores 234
Baseline surveys 270
Bioadditives 103
Body dressing 139
Borehole latrines 74, 273
Budget 195, 196, 201, 208, 260, 280, 334
Burial 44, 139, 140, 231

C

Calculations 19
Cemetery 139, 231,
Checklists 224, 226, 276
Checklist analysis 211, 290, 336
Chemical toilets 67
Children 8, 18, 58, 71, 143, 168, 181, 269
Cholera 136, 161
Cholera treatment centres 161
Climatic conditions 22, 146
Communal latrines 62, 63, 87
Communication channels 170
Community mobilisation 182
Community participation 169, 177 - 188, 269
Community volunteers 265, 278
Composting 118
Composting latrines 81, 82
Concrete 91 - 93

Cost-effectiveness 280, 291
Cost recovery 188
Cremation 44, 47, 138, 140, 231, 246

D

Dead bodies 44, 46, 135 - 139, 231, 246, 274
Deep trench latrines 69
Defecation fields 64, 65
Demographic data 22, 227
Design and construction 62, 88, 203
Design process 258, 268
Desludging 101
Detail programme design 189, 267
Diagramming 184, 270
Diarrhoea 8, 58, 136, 164, 166, 223
Disabled people 88, 169, 269
Diseases 8, 58, 105, 135 - 137, 163, 223
Disinfection 42, 46, 127, 139
Donors 195, 198, 260, 281
Dysentery 8, 57, 223

E

Ebola 46, 137
Elderly people 58, 181
Emptying pits 101
Environment 9 - 11, 22, 24, 276
Epidemics 47, 136, 139
Equipment 16
Evaluation 211, 290, 343
Evaluation report 213, 215, 291
Evaporation pans 153
Evapotranspiration beds 154
Excavation 59, 78, 95
Excreta disposal 32, 34, 57 - 103, 228, 236, 272, 298

F

Family latrines 35, 62, 65, 86, 273
Finance 187, 201
Finance generation 187
Focus groups 170, 185
Fuel for cremation 47, 231, 246

G

Gantt chart 193, 278
Gender 23, 54, 168, 181, 225, 269
Graveyards 139
Grease traps 156

INDEX

Ground conditions 27
Groundwater 28, 78, 80, 88, 105, 120, 136, 145

H

Handwashing 8, 34, 35, 164, 170, 275
Health risks 8, 58
Hygiene and health 165
Hygiene promotion 53, 163 - 174, 233, 275, 332, 335

I

Immediate measures 63, 131, 263,
Implementation 199, 283
Implementation components 199, 286
Incineration 42, 117, 127
Incinerators 128
Infiltration trenches 151
Interpretation of results 250
Interviews 18, 54, 203, 270
Irrigation 155

J

Job descriptions 278

K

Kitchens 48, 144, 155

L

Landfilling 36, 116
Latrines 32, 34, 60 - 99, 228, 236, 237, 273
Latrine slabs 61, 89 - 92, 94
Log-frame analysis 209, 289
Logical framework 190, 209, 277, 332
Logistics 61, 201, 202, 279

M

Malaria 8, 105, 163
Management 200, 201, 204, 205, 288
Mapping 183, 270, 17
Materials and equipment 200
Médecins Sans Frontières 214, 295
Medical centre 121, 122 - 133, 230, 244, 274, 317 - 319
Medical waste 121 - 133, 230, 274
Meetings 29, 183, 185, 204
Men 168, 181, 233
Menstruation 60
Mental health 136
Monitoring 207 - 211, 289, 290, 336

Monitoring and evaluation 206, 289 - 291, 336 - 348
Monitoring reports 213, 290
Morbidity 10, 11, 203, 223
Morgue 46, 138
Mortality 10 - 12, 203, 223
Mosquitoes 8, 50, 57, 105, 136, 143

N

Natural drainage 152, 275

O

Observation 17, 226
Organisations 17, 29, 227
Outline programme design 219, 257, 328
Outline programme proposal 260
Overhung latrine 73, 74, 273

P

Packet latrine 67
Participation matrix 181 - 182
Participatory appraisal techniques 183 - 185
Pathogens 57, 81, 139, 143, 163
Personnel 61, 194, 199, 200
Pit excavation 95
Pit latrines 68, 78 - 80, 95, 98, 273
Pit lining 95 - 96
Placenta burial pits 131
Pollution 78 - 80, 105, 123, 136, 140, 145
Pour-flush latrines 71
Priority setting process 253
Problem-tree analysis 185
Programme design 189, 257, 267, 328, 332
Programme proposals 198, 260
Protective clothing 47, 119, 124, 139, 229, 230

Q

Questionnaires 270

R

Rainfall runoff 161
Raised pit latrine 79
Ranking 184
Recommended minimum objectives 31, 234
Reconnaissance 17, 226
Recruitment 167, 199, 288
Reed beds 158 - 160
Refugee camps 24, 179, 295, 296

INDEX

Remuneration 178, 200
Reports 21, 204, 213 - 215
Report writing 213
Resources 279

S

Sand-enveloped pit latrines 80
Sector results 250
Security 7, 200, 206
Septic tanks 83, 99, 100
Settlement tanks 156, 157
Sewerage system 77, 85
Shallow trench latrines 64
Sharps 42, 43, 122, 125, 126, 128, 130, 230
Simple pit latrines 68
Sizing pits 97
Sludge accumulation 97, 98
Sludge disposal 103
Smoke pollution 106, 128, 140
Soakaway 27, 147
Soakpit 28, 144 - 151
Soap 119, 137, 139, 164, 170
Socio-cultural acceptability 32 - 54, 146
Soil 27, 28, 59, 79, 95, 96, 111, 116, 140, 144, 147
Solid waste 36, 38, 39, 105 - 120, 122, 127, 229, 239 - 243, 273, 310 - 316
Sphere Project 31, 173, 234
Squat-hole cover 94
Staff 10, 15, 61, 167, 179, 194, 199, 200, 225, 278, 287
Stakeholders 14, 179, 180, 181, 265, 267 - 269
Stakeholder analysis 179, 180, 268
Superstructure 70, 89
Surveys 18, 270, 271
SWOT analysis 207, 289, 339

T

Tanzania 22, 25
Time 60, 97, 202, 220, 277, 287
Time targets 220
Topography 145
Training 132, 167, 177, 183, 200, 203, 206,
Transportation of waste 114, 127
Trench latrines 64, 65, 69
Twin pit latrines 79

U

UNHCR 19, 22, 182, 296
Urine 81, 82, 97

EMERGENCY SANITATION

V

Vacuum tanker 101, 102

Vector 105, 119, 123, 143, 163

Ventilated improved pit latrine 70, 71

Ventilation pipes 94

W

Washing 8, 34, 35, 60, 124, 137, 164, 170, 275

Waste bin 113 - 114

Waste pit 111, 112, 127

Wastewater 27, 28, 48, 50, 51, 83, 99, 143, 161, 173, 232, 247, 275, 322, 323

Water 8, 24, 60, 71 - 74, 77, 83 - 85, 88, 120, 124, 136, 145

Women 18, 60, 168, 181, 183, 226, 269

Z

Zambia 183, 214, 293,