

Inclusive WASH

Menstrual Hygiene Management Friendly and Accessible WASH Facilities for Emergencies

Manual for Template Designs

21 MARCH 2022



Humanitarian
innovation fund

elrha

Foreword

MHM is not only about distributing pads or providing information. Access to private, safe and inclusive WASH facilities for bathing, laundering and disposing of menstrual materials is essential. However, time constraints and pressure to deliver 'hardware' in humanitarian contexts often means that WASH actors make use of 'standard' emergency designs or make assumptions about the needs of those affected.

Standard emergency latrine or bathing area designs are often not appropriate for people who menstruate, including those with disabilities, to be able to manage menstruation in a private, safe and dignified way. For example, they may not have adequate privacy or safety (e.g. internal locks, lighting, poor siting), or may overlook the need for disposal or appropriate drying spaces.

Rather than engineers making assumptions or using inappropriate standard designs which do not address menstrual hygiene and accessibility needs, our solution was to develop, pilot and refine rapid planning tools and adaptable designs for MHM and disability friendly latrines, bathing, and laundering areas.

Emphasis is placed on preferences, cultural norms, practices and beliefs around menstruation, blood and personal hygiene. This will mean WASH facilities can more effectively meet the needs of users (of all ages and abilities) right from the onset of any humanitarian crisis.

This manual presents three adaptable designs for a trench latrine block, raised latrine block and bathing block. Development of these solutions followed a user-centred approach to understand the main barriers, challenges and opportunities that WASH, and shelter practitioners perceive, when designing and implementing WASH facilities that enable women and girls to manage their menstruation. The guidance and tools developed were based directly on this learning and recommendations from end-users (WASH & shelter practitioners).

The solutions presented in this manual are intended to be adaptable for a wide range of contexts, and therefore the design information is accompanied by guidance on how to assess the needs of the target community and local site constraints.

We hope that they can be useful and support you in designing and planning emergency WASH facilities that meet the needs of all users.

If you have any queries or would like further information on the designs or content of this manual, please contact:

Alexandra Machado Soergel

WASH in Public Health Senior Officer, Health & Care Department

International Federation of Red Cross and Red Crescent Societies

Alexandra.Machado@ifrc.org

Debora Bonucci

WASH Adviser, International Directorate

British Red Cross

DBonucci@redcross.org.uk

Acknowledgements

This manual was funded and supported by Elrha's Humanitarian Innovation Fund (HIF) programme, a grant making facility which improves outcomes for people affected by humanitarian crises by identifying, nurturing and sharing more effective, innovative and scalable solutions. Elrha's HIF is funded by aid from the UK Foreign, Commonwealth and Development Office (FCDO). Elrha is a global charity that finds solutions to complex humanitarian problems through research and innovation. Visit www.elrha.org to find out more.

The project team was led by the Health and Care Department of the International Federation of the Red Cross and Red Crescent. The British Red Cross and Lebanese Red Cross provided support including stakeholder consultations and pilot implementation.

Arup International Development provided technical assistance to develop the template designs and compile the manual contents.

Contents

1	How to use this manual.....	1
	Definition of key terms	1
1.1	Audience	1
1.2	Manual Roadmap.....	2
1.3	Where to Find Supporting Information	3
	Section A – MHM Friendly and Accessible Design Specification	4
2	Key Principles and Considerations for MHM Friendly and Accessible Design.....	5
	Section B – Fundamentals of WASH Facility Site Selection and Design	9
3	Site Selection & Planning	10
3.1	Assumptions and Limitations	10
3.2	Site Checklist.....	10
4	WASH Performance Specification	13
4.1	Number of users.....	13
4.2	Private disposal system for menstrual material	13
4.3	Handwashing (provided in the latrines).....	14
4.4	Bathing Provisions (in the Bathing Block)	14
4.4.1	Bathing Greywater Collection.....	15
4.5	Greywater Disposal	15
4.5.1	Greywater discharge rates	16
4.5.2	Connection to an existing drain	17
4.5.3	Discharge to a greywater storage tank	17
4.5.4	Discharge to a soakaway or infiltration trench	17
4.6	Solid Waste Collection & Disposal (Latrines).....	20
4.6.1	Latrine types.....	20
4.6.2	Waste storage volume – Trench Latrines	20
4.6.3	Trench Decommissioning.....	21
4.6.4	Waste storage volume – Raised Latrines	21
4.6.5	Desludging Approach	22
4.7	Ventilation.....	22
4.8	Surface water management	22
4.9	Rainwater management	22
4.10	Lighting.....	22
5	Structure Performance Specification	23
5.1	Structural Design Codes	23

5.2	Design Life	23
5.3	Materials	23
5.3.1	Timber	23
5.3.2	Plastic Sheeting.....	24
5.3.3	Connections	24
5.4	Foundations.....	24
5.5	Wind Loading	25
5.6	Seismic Loading.....	26
Section C – Template Designs.....		27
6	Template Design 1: Trench Latrine Block.....	28
6.1	Trench Latrine Block Bill of Quantities	29
6.2	Trench Latrine Block Architectural Drawings and Visualisations	32
6.3	Trench Latrine Block Panel Lists & Diagrams.....	33
6.4	Trench Latrine Block Step-by-Step Construction Sequence	34
7	Template Design 2: Raised Latrine Block.....	35
7.1	Raised Latrine Block Bill of Quantities	36
7.2	Raised Latrine Block Architectural Drawings and Visualisations	39
7.3	Raised Latrine Block Panel Lists & Diagrams.....	40
7.4	Raised Latrine Block Step-by-Step Construction Sequence	41
8	Template Design 3: Bathing Block.....	42
8.1	Bathing Block Bill of Quantities	43
8.2	Bathing Block Architectural Drawings and Visualisations	46
8.3	Bathing Block Panel Lists & Diagrams.....	47
8.4	Bathing Block Step-by-Step Construction Sequence	48
Appendix A: Supplementary Technical Information		50
A.1	Infiltration Test Guide.....	51
A.2	Rainwater Harvesting.....	52
A.3	Combined Latrine and Bathing Block	55
Appendix B: Product and Equipment Information		56
B.1	Component Details	57
B.2	Handwashing unit: Jengu	58
B.3	Butyloo Shower Tray.....	59
B.4	Accessible Latrine Option 1: ICONO Add-On.....	60
B.5	Accessible Latrine Option 2: K. K. Nag	61
B.6	Butyl Collar.....	62
Appendix C: Operation & Maintenance.....		63

1 How to use this manual

This manual provides **guidance on implementing three template designs for WASH facilities that meet the needs of menstruators with different abilities: A Trench Latrine Block; a Raised Latrine Block; and a Bathing Block.**

This information is intended to help field practitioners, in **the acute initial emergency response phase** of establishing facilities for crisis affected people.

The template designs should not be used without being adapted to the context. The manual includes guidance on how to assess site specific constraints and adapt the designs accordingly.

A practical manual for implementing MHM Friendly & Accessible WASH Facilities in acute emergency phase

Definition of key terms

“MHM Friendly” and “Accessible” are the two key terms used to characterise the type of WASH facility this manual aims to describe. The solutions proposed are primarily aimed at the acute initial phase of emergency response, albeit with consideration of adaptability for extended use. Therefore it is important to define what these terms mean in the context of this manual:

Menstrual Hygiene Management (MHM) Friendly	A range of actions and interventions that ensure people who menstruate can privately, safely and hygienically manage their menstruation with confidence and dignity. ¹
Accessible (and Accessibility)	People-centred, inclusive design incorporating features to ensure a diverse range of people can use the facilities. This includes consideration of space and equipment to address physical needs (including People with Reduced Mobility (PRM), people with carers, elderly people, people with children, and children) and more social/cultural aspects such as genders, behavioural norms, taboos, cultural restrictions.
Acute emergency response	The 4–5-month period immediately following a sudden onset disaster or emergency when immediate, prioritised needs must be addressed through rapidly deployed solutions. These solutions are often gradually improved and adapted for extended use beyond the emergency response phase. So whilst 4-5 months may be considered the minimum design life, integration of adaptability for longer term use should be considered.

1.1 Audience

This manual is targeted at people within the Red Cross and Red Crescent Movement working in the acute first phase of an emergency response. The primary audience is field practitioners responsible for planning and implementing WASH facilities. It is also intended to inform those planning and managing WASH programmes. It is assumed that readers have a strong understanding of the need for participation, and experience in ensuring the close involvement of crisis affected people².

¹ IFRC, July 2019, Menstrual Hygiene Management (MHM) Guide and Toolkit, Second review

² For more information about Community Engagement and Accountability (CEA) refer to: <https://media.ifrc.org/ifrc/what-we-do/community-engagement/>

1.2 Manual Roadmap

Users are guided through adaption and implementation of the designs by these three sections (it is recommended that all three sections are reviewed prior to procurement and installation):

A

Section A – MHM Friendly and Accessible Design Specification

Explains the requirements for MHM Friendly and Accessible facilities, and details the features included in the template designs to address these needs. Any adaptations should ensure these features and principles remain intact.

B

Section B – Fundamentals of WASH Facility Site Selection and Design

Explains the performance specification the template designs are designed to meet (and therefore what conditions they are suitable for) and provides guidance on identifying and implementing adaptations to specific contexts. This includes information on aspects that will need to be finalised according to the site conditions, prior to procurement and installation. For example selection of the greywater discharge according to available drainage options onsite.

C

Section C – Template Designs

Package of drawings, BOQ and construction guidance for each template design which, following context specific adaptation, can be used for procurement and installation.

All three blocks provide two general cubicles and one accessible cubicle.

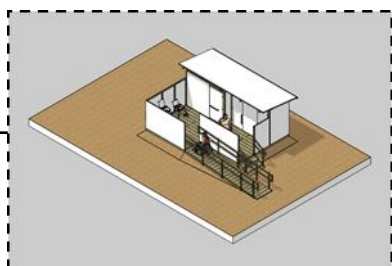

Template Design 1: Trench Latrine Block:

Appropriate for sites where the ground conditions allow safe excavation, without risk of groundwater contamination. Two handwashing units are included. The block is raised 30 cm to prevent water entering the trench in rainy season. Access to the toilet block is provided by a short ramp and stairs.

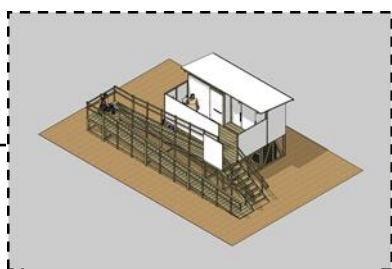

Template Design 2: Raised Latrine Block:

Appropriate for contexts where a trench latrine cannot be built, due to high groundwater table, rocky soil or other limiting conditions. Two handwashing units are included. Access to the raised platform is provided by ramp and stairs. Faecal sludge is collected in tanks underneath the platform. The tanks can be desludged through a bottom flange, or through a lateral access in the top, to avoid desludging through the latrine hole.

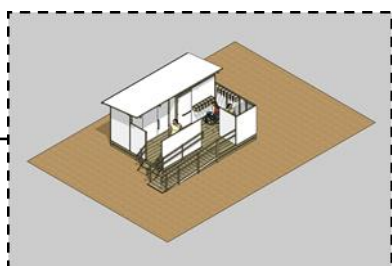

Template Design 3: Bathing Block: Suitable for different contexts, including sites with high groundwater table or rocky soil. It does not require excavation. The block is composed of two general cubicles and one accessible cubicle. Access is provided by a ramp and stairs. The design incorporates elements that allow washing of reusable menstrual material and a drying area for them to sun-dry.

1.3 Where to Find Supporting Information

This manual is not intended to replace or duplicate existing MHM and Accessibility Guidance or existing technical guidance on approaches to WASH facilities. Instead, this manual aims to complement those existing information sources by collating and translating the relevant information into a practical manual for implementation. To keep this document concise and practical, the manual references external guidance wherever appropriate, particularly to provide detail on supporting information.

This is not an encyclopaedia of WASH methods and solutions. It focuses on practical integration of MHM and accessibility

The basic WASH solutions employed by the template designs are based on three UNHCR manuals for emergency WASH facilities:

- [WASH Manual D400-2015a: Emergency Trench Latrine Poles + Plastic](#)
- [WASH Manual D405-2015a: Emergency Raised Desludgable Holding Tank Latrine](#)
- [WASH Manual D700-2015a: Emergency Communal Shower](#)

Modification to these original designs has been made based on international best practice and developed through consultation with WASH experts from the International Federation of Red Cross and Red Crescent Societies (IFRC) and the British Red Cross (BRC). These modifications were focused on integrating features for MHM and accessibility. Whilst some adjustments were made to improve functionality and practicality based on feedback from advisors with field experience, in general this manual does not attempt to re-evaluate the basic WASH techniques used in the original UNHCR designs. Fundamentally, it is understood that the facilities in the UNHCR manuals were designed to meet the needs of an emergency response and were developed using appropriate research and expertise.

The following documents are also referenced in the report:

[Menstrual Hygiene Management \(MHM\) Guide and Toolkit, Second review, IFRC, July 2019](#)

[Protection, Gender And Inclusion In Water, Sanitation And Hygiene Promotion, IFRC, 2021](#)

[A Toolkit For Integrating Menstrual Hygiene Management \(MHM\) Into Humanitarian Response, Columbia University & IRC, 2017](#)

[The Sphere Handbook: Humanitarian Charter and Minimum Standards in Humanitarian Response, Sphere, 2018](#)

Section A – MHM Friendly and Accessible Design Specification

This section explains the key considerations for MHM Friendly and Accessible WASH facilities, and the associated features included in the template designs.

2 Key Principles and Considerations for MHM Friendly and Accessible Design

The IFRC [Dignity, Access, Participation, and Safety \(DAPS\) Framework](#)³ helps identify key characteristics and principles for MHM Friendly & Accessible design:



Dignity is supported through facilities that respect, protect and promote privacy and independence.

In certain cultures, people who menstruate feel embarrassed if other people know they are using the toilet, in particular for managing their period. This can be driven or exacerbated by social and cultural taboos around menstruation. Methods of collecting and washing or disposing of MHM materials, along with disposal of water used for personal washing during menstruation, must be discreet to instil confidence in using the facility.

Dignity is also a critical component of inclusive, accessible design which supports users with a diverse range of needs.



Accessibility is the primary requirement for inclusive facilities. This means ensuring users of all mobilities can freely and safely reach, enter and use the facility. The design should mitigate barriers to access through careful space planning and the inclusion of appropriate equipment. As much as possible, the facility should empower independence, but should also provide adequate space for those accompanied by carers.



MHM practices are very context specific. **Consultation with the user community is essential** to ensure the success of the design. The facility's implementation should be aligned with hygiene promotion activities to enhance the users' behaviours towards the facilities.

It is also important to foster collaboration between the many actors that influence successful implementation, including the site planning, health and hygiene promotion teams and other stakeholders.



Guidance on community consultation can be found in the [IFRC MHM Guide & Toolkit](#)



Users should both be and feel safe while using facilities. In addition to considerations relating to protection from abuse, this also has implications for ensuring the structure itself is fit for purpose, and provisions are made to safeguard health and wellbeing.

Table 1 describes the characteristics of WASH facilities that support MHM and make them accessible to users with different physical abilities. Alongside each characteristic, the related design features that have been included in the template designs (and some possible variations) are listed. Field staff should be familiarised with this list, especially because many of the items are atypical for standard emergency facilities, and therefore it will be necessary to raise awareness and understanding of the importance of including these components. This list can also be referenced when adapting the template designs to ensure MHM Friendly and Accessibility elements are maintained.

³ <https://media.ifrc.org/ifrc/what-we-do/inclusion/protection-gender-inclusion/> [Accessed 16.06.21]

Table 1 MHM Friendly & Accessible Features in the Template Designs

Characteristic	Design Features
<p>Communal Facilities: Communal facilities are preferred to stand-alone units as they provide more privacy to people using the individual cubicles contained within the surrounding unit.</p>	<p>Single entrance for safety. Facilities are screened for privacy.</p>
<p>Signage and Information: Facilities need to be clearly signed as women and disability friendly. It is important to provide information on how to use the innovative elements such as the disposal system or the washing and drying area to avoid misuse. The space could also be used to advertise important MHM information for the users such as how to wash, dry and store reusable pads appropriately or even link to health clinic services.</p>	<p>Facilities are clearly signed. Information sheet on how to use the facilities are included in each cubicle. The signage and information should be developed locally to ensure suitability for the target community. Visual signage based on pictures or pictograms is generally recommended, so it is understandable to all the users. Instructions and communications must be inclusive, ensuring that stereotypes are not reinforced, and people of different ages and disabilities are integrated throughout.</p>
<p>Ramp access: A ramp with handrails should be provided for people with reduced mobility.</p>	<p>Ramp inclination no more than 1:12 (4.8 degrees) - for a person in a wheelchair to be able to use without assistance. Landing areas provided at the top and bottom, and at changes of direction. For longer ramps, include landings to create rest points. Handrail diameter 4-6 cm.</p>
<p>Step access: Steps should be provided along with the ramp access. This reduces traffic on the ramp for those that need it most; and also provides an alternative for people who have reduced mobility but can walk and may find the incline and/or distance of a ramp is a greater challenge than steps.</p>	<p>Step size: no more than 160mm high and at least 280 mm deep to be adequate for people with disabilities. Edge of the steps painted yellow to provide contrast for visually impaired people</p>
<p>Space: The accessible cubicle (for toilets and showers) should be wider than the general one. Extra space is needed for users in wheelchairs to manoeuvre and/or for those accompanied by carers.</p>	<p>The template designs include accessible cubicles sized and configured to conform to good international practice in accessible design. These dimensions should be maintained during any adaption of the facility. Accessible cubicle size: 1650 x 2500mm</p>
<p>Door: The doors should safeguard privacy by closing fully, without any surrounding gaps</p>	<p>Doors are sized to cover the doorway.</p>
<p>Door handle: Adequate handles on both sides of the door should be provided. These should be different for general and accessible cubicles. The handle should be sized and positioned to ensure it is easy to use for everyone.</p>	<p>General cubicle door handle: 500mm long vertical handle at 900mm height. Accessible cubicles door handle: 500mm long horizontal handle centred at 900mm height.</p>
<p>Door locks: Door locks are crucial for the user's privacy and safety. Locks should be easy to use for everyone – e.g. avoid awkward/stiff mechanisms or small pieces that may be difficult to grip/operate.</p>	<p>Easy to use door locks: a chunky bolt of at least 4 cm long is recommended and should be located below the handle.</p>

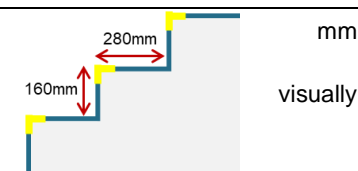

Characteristic	Design Features
Self-closing doors: Self-closing doors are recommended to limit touchpoints, and to avoid mosquitoes entering the cubicles. This could be provided using a simple mechanism available locally such as self-closing door hinges or springs.	Doors are self-closing.
Shelf and hangers: A shelf and hangers inside the cubicles allow the user to store their clothes and belongings, and manage sanitary materials, whilst using the toilet or bathing.	Shelf: 200mm deep x 800mm long at 800mm height. Hangers provided at 1200mm height.
Handrails: Handrails on the walls provide support to people with difficulty squatting or standing. In the accessible cubicle, handrails would be used by a person in wheelchair to transfer themselves to the toilet or shower seat.	Handrails provided in toilets and showers: 500mm long, horizontal at 600mm height.
Accessible toilet seat / shower seat: A seat for people with reduced mobility should be provided in the accessible toilet and shower cubicles.	<p>Accessible toilets seats can be found in the humanitarian market. The template designs reference two products:</p> <ul style="list-style-type: none"> ▪ The KKnag accessible platform that incorporate a seat and handrails. ▪ The Icono add-on, which is a seat that can be added to some squatting platforms. <p>Alternate products may be used or fabricated locally. These should be based on matching the dimensions of the example products (or adapt the cubicle design to accommodate any differences).</p> <p>The shower seat should be in/over the shower tray (allowing people to sit while washing).</p>
Disposal system: The disposal of menstrual material is a major concern among users. The fear of people seeing/ accessing used pads and other beliefs and stigmas may prevent people from using the facilities. A chute disposal system where the pads can't be seen or accessed once they are disposed will provide confidence to the user. The disposal system should be available in both toilets and bathing cubicles. Information on how to use the disposal chute should be displayed in the toilets and provided to the user.	<p>The chute system used in the template designs is described in detail in Section 5. The key characteristics to give confidence to users are:</p> <ul style="list-style-type: none"> ▪ Disposal point is inside the cubicle for privacy ▪ The receiving container is sealed and can be removed without exposing the contents.
Mirror: A mirror inside the cubicles allows menstruators to check their clothes for blood stains caused by leaks. The mirror should be sized and positioned such that it allows the user to check their lower body.	Three-quarter mirror (300mm wide x 800mm long) installed at 900mm height in general cubicles and 600mm height in accessible cubicles (height is from floor level to bottom of mirror).
Bell: Users usually express fear of being followed if using the facilities at night, whilst children fear getting locked inside. A bell inside the cubicles would allow the user to call for help if needed. The community should agree how to proceed in case of alarm using the bell.	Bell hung from the roof at a height that is reachable for children and people in wheelchairs. The bell could be purchased or fabricated locally.

Characteristic	Design Features
<p>Washboards</p> <p>Menstruators need a private space to wash their reusable pads and stained underwear. A common practice is to wash these items whilst bathing. Therefore, a wash board should be incorporated in the shower. Washboards could be purchased or made locally. Common designs are made from a galvanised or stainless steel ridged surface (to rub the clothes) in a wood frame.</p>	<p>Washboards are provided in the shower cubicle that are:</p> <ul style="list-style-type: none"> ▪ small - to discourage their used for other type of laundry that is not reusable pads or underwear ▪ attached to the wall - to avoid vandalism ▪ inclined over the shower plate - for the water to drain with the rest of the greywater.
<p>Drying area: Menstruators usually don't feel comfortable drying their reusable pads, underwear, and items of clothing at home where other family members or neighbours can see them. The lack of a private place to sun-dry the pads can lead to practices that put health at risk. Providing a drying area in the facilities is therefore essential. Local consultation may inform whether the users would prefer drying lines or lockable boxes – and the provision can be adapted accordingly.</p>	<p>Drying area provided:</p> <ul style="list-style-type: none"> ▪ Open to external air (no roof) to allow the clothes to dry in the sun to kill bacteria (but with screening to maintain privacy). ▪ Drying lines and/or; ▪ Small drying boxes (with the option to be locked) that allow people to dry their pads privately.
<p>Handwashing units: Handwashing should be provided close to the cubicles where people can privately wash their hands. In the template designs the handwashing units have been located directly outside the cubicles within the toilet block to reduce waiting time and queues.</p> <p>Discreet drainage of greywater will address anxiety around any bloody water being visible.</p>	<p>Details of the proposed handwashing units and greywater solutions are provided in Sections 5.3 and 5.5 respectively.</p> <p>Key features of the handwashing units are:</p> <ul style="list-style-type: none"> ▪ Hands-free (such as foot/ arm pump or pedal) to prevent cross contamination. ▪ Tap height: <ul style="list-style-type: none"> ○ General units: 900-1000mm ○ Accessible units: 700mm to 900mm
<p>Note: The following resource has good examples and design features of simple locally made options for toilet and washing facilities: https://www.cbm.org.au/wp-content/uploads/2019/02/CBM-World-Vision-Home-WASH-modifications-Sri-Lanka.pdf.</p>	

Section B – Fundamentals of WASH Facility Site Selection and Design

This section explains fundamental aspects of WASH Facility design which must be understood and considered for successful adaption and installation, including considerations for site selection.

This manual is specifically aimed at defining requirements for MHM Friendly and Accessible WASH facilities for sites accommodating crisis-affected people, established during the acute emergency response phase. Therefore, it is not intended to be a manual on latrine and shower design generally, as there is a wide array of existing guidance material on this subject. However it is intended that the information provided will inform field staff in developing context-appropriate solutions. To enable appropriate adaptation, it is important that some fundamental aspects of WASH facilities are understood and similarly that the methods that form the basis of the template designs are clearly defined.

3 Site Selection & Planning

Site selection is based on identifying potential locations that have sufficient space to accommodate the facility and meet other requirements such as proximity to the community to be served and availability of water supply. It is likely that some compromise will be necessary on these requirements due to the intrinsic constraint of the location and condition of the settlement to be served. Any challenges (or shortcomings) of the available site should then be addressed through mitigation measures identified during planning. This is an important stage of implementation as it will determine certain decisions such as method of greywater disposal; and may also identify adaptation of the design that is needed to suit the site-specific conditions.

3.1 Assumptions and Limitations

The following key assumptions should be reviewed and confirmed prior to implementation of the facilities:

- Implementation of the facilities will be overseen by a technically qualified person familiar with these types of constructions. Carpenters and painters may be needed to build the facilities.
- Site selection: the proposed site has been assessed to be suitable for the construction of these facilities; and appropriate permissions/approvals have been granted by the local authorities and/or camp management.
- Latrine and bathing blocks will be built only on competent ground conditions (i.e. weak rock, stiff clays, dense sand and gravels).
- Available hazard information for each deployment location has been reviewed to ensure the conditions for that location fall within the design parameters given below. Further advice should be sought where available data suggests that conditions are outside these parameters or where no data is available.
- Compliance with local requirements: The field team are responsible for ensuring compliance with statutory requirements, local building regulations, codes, insurance certification or other requirements or recommendations relevant to the location where and materials with which they plan to build.

Examples of local conditions that will change the design include climate (flooding, temperature variation, insects), soil mechanics (foundations), seismic characteristics (earthquakes) and legislation regarding inclusive safe access (including emergency egress for fire).

3.2 Site Checklist

Table 2 explains the key requirements that must be addressed when selecting a site for WASH facilities and may be used as a checklist in the field.

Table 2 Site Selection & Planning Checklist

Requirement	Checklist items
<p>Stakeholder Consultation</p> <p>Cultural and social aspects could influence the site selection and the adequacy of the facilities. For example, Muslim communities may not want to orientate the facilities towards Mecca. Stakeholder consultation is vital to understand the cultural requirements of the WASH facilities.</p>	<p><input type="checkbox"/> Consult user group to understand context specific site requirements and add to/adapt checklist as appropriate.</p>
<p>Space Requirements</p> <p>The basic area required for each of the template designs is listed in the adjacent column. Refer to Step 1 of the respective construction sequence (in Section C) for diagrams and further details. Refer to section 6 for guidance on propping requirements.</p>	<p>The following areas will accommodate the basic structure. Refer to the plans for indication of additional clearances:</p> <p>Trench Latrines: 5m x 6.5m (or 6m x 6.5m if propping required)</p> <p>Raised latrines: 11m x 6m (or 11m x 7m if propping required)</p> <p>Bathing Block: 5.2m x 8m (or 6.2m x 8m if propping required)</p>
<p>Privacy and Safety Requirements</p> <p>Privacy, safety and dignity of the user are key requirements for selecting the site of the MHM facilities. Consultation with people who menstruate and vulnerable groups on their preferred site is crucial.</p> <p>In certain cultures, people who menstruate feel embarrassed if other people know they are using the toilet, in particular for managing their period. Facilities could be built in Psycho-social support (PSS), DAPS centres or other places where people usually go for other activities and are away from family members. Combining the toilets and showers with other 'women-only' facilities makes it less evident a someone is entering a facility to use the WASH provisions, giving dignity and privacy.</p> <p>A discreet drainage system is essential in MHM facilities. Menstruators may feel discouraged from using the facilities if they think stained greywater from handwashing, shower or washing sanitary material can be seen by others. The viability of greywater disposal options must be assessed before selecting the site – Refer to Section 5 for more details.</p>	<p><input type="checkbox"/> Consider potential to integrate with suitable (e.g. "women-only") facilities</p> <p><input type="checkbox"/> Well-lit location</p> <p><input type="checkbox"/> Avoid areas where people tend to gather for other purposes</p> <p><input type="checkbox"/> Located away from facilities frequented by male members</p> <p><input type="checkbox"/> Accessible water supply via one of the following:</p> <ul style="list-style-type: none"> ▪ Mains connection and/or ▪ Water tank or ▪ Close to a water point (within 50m) <p><input type="checkbox"/> Opportunity for discreet discharge of greywater (may include nearby drain and/or suitable area of ground for a soakaway).</p>
<p>Accessibility Requirements</p> <p>Accessibility is the main requirement for inclusive facilities.</p> <p>The toilet and bathing block should be in proximity to people with disabilities.</p> <p>The site of the facilities needs to be a place with easy access.</p>	<p><input type="checkbox"/> Maximum distance of 15 m to the households served, for accessibility for any persons with disabilities.</p> <p><input type="checkbox"/> Path to site clear of obstacles (such as holes, open drains, trunks, branches, tent ropes).</p> <p><input type="checkbox"/> Any hazards that can't be avoided are marked and fenced.</p> <p><input type="checkbox"/> Pavements and lanes in the surrounding community should be a minimum of 90cm wide.</p>

Requirement	Checklist items
<p>WASH requirements</p> <p>The location of the toilet and bathing blocks has implications for their functionality and the ability to maintain them as safe and hygienic.</p> <p>The location should also safeguard against cross contamination of other facilities such as homes and water sources.</p> <p>To avoid the accumulation of muddy areas and stagnant water around the facilities, proper drainage around the facilities should be provided and linked to the surface water management strategy of the settlement.</p>	<ul style="list-style-type: none"> <input type="checkbox"/> Clean and level site <input type="checkbox"/> Prevention of surface and groundwater contamination by: <ul style="list-style-type: none"> <input type="checkbox"/> Located at least 30m away from water sources. <input type="checkbox"/> The bottom of the trench and soakaways must be at least 1.5 m above the highest average ground water table level. <input type="checkbox"/> These distances should be increased for fissured rock and limestone. <input type="checkbox"/> At least 6m away from shelters (but never further than 50m for accessibility) <input type="checkbox"/> Consider feasibility of integration with settlement surface water management strategy. <input type="checkbox"/> Access for desludging operations (driveable route for truck, space to manoeuvre and park).
<p>Hazard mitigation</p> <p>The facilities should be located in areas where hazard risks are as minimal as possible.</p> <p>Where hazards cannot be avoided due to the constraints imposed by the community location, they should be noted and addressed through mitigation measures. This may include adaption of the design prior to implementation and/or aligning with the settlement Disaster Risk Reduction plans.</p> <p>*Fire is both a siting and planning issue. The notes adjacent provide basic guidance with respect to mitigating the spread of fire through separation of structures. The facilities should be planned with reference to the settlement fire strategy, aligning with its requirements and incorporating any implied adaptation/addition to the design (e.g. allowing space for fire trucks, adding firefighting elements such as sand buckets).</p>	<ul style="list-style-type: none"> <input type="checkbox"/> Wind, Storm & Hurricanes: Avoid open areas exposed to strong winds. <input type="checkbox"/> Flood: locate on higher ground, away from flood plains and, if possible, away from locations with high water tables. <input type="checkbox"/> Landslide: avoid areas vulnerable to landslides (on or at the bottom of steep slopes). <input type="checkbox"/> Fire*: The settlement should be planned leaving gaps between shelters and facilities to provide fire breaks <input type="checkbox"/> Other hazard sources: locate adequate distance from potential hazards sources to avoid risks such as partial landslides and the collapse of nearby elements (trees, poles, electrical wires, other constructions). <p>Hazards with implications for planning</p> <ul style="list-style-type: none"> <input type="checkbox"/> Earthquake: If the settlement is located in a seismic area, locate away from fault lines if possible, as well as from areas where liquefaction occurs such as river beds, coastal areas with sandy soils and high water tables. See also notes on seismic in the Section 6. <input type="checkbox"/> Tidal surge and Tsunami <input type="checkbox"/> Volcano <input type="checkbox"/> Other (note any additional hazards identified during site selection that need to be considered and addressed through planning).

4 WASH Performance Specification

This section provides details on the various WASH components of the facility and the performance specification that is applied through the template designs.

4.1 Number of users

The template designs are intended to be modular, meaning the capacity can be adjusted to suit the size of the population served by the facility. **The baseline template designs (effectively, one module) have been sized based on serving 60 users.**

If the templates are extended to serve a larger population, the various design components (e.g. tank sizes) should be increased proportionally.

4.2 Private disposal system for menstrual material

The disposal chute system consists of a pipe of 150mm diameter with a lid connected to a locked container located outside the cubicle (for the raised latrines it is below the platform, for the trench latrines and bathing block it is adjacent). There is one per cubicle.

In raised latrines, the pipe could be attached to the floor of the cubicle emulating a normal bin. In trench latrines, the pipe could be attached to the wall. Wherever possible the pipe should be connected vertically to the waste container. Where a vertical connection is not possible elbows should be avoided and the inclination should be as steep as possible to avoid pads getting stuck. Applying grease inside the pipes prior to installation may also help prevent pads from sticking.

The orientation of the waste container can be adjusted depending on whether the facility is a raised latrine block or a lower trench latrine or bathing block (Figure 1). Only authorised personnel should have access to the locked containers for removal and further disposal or elimination of the content.

It is important to display information inside the toilets on how to dispose the menstrual material using the system.

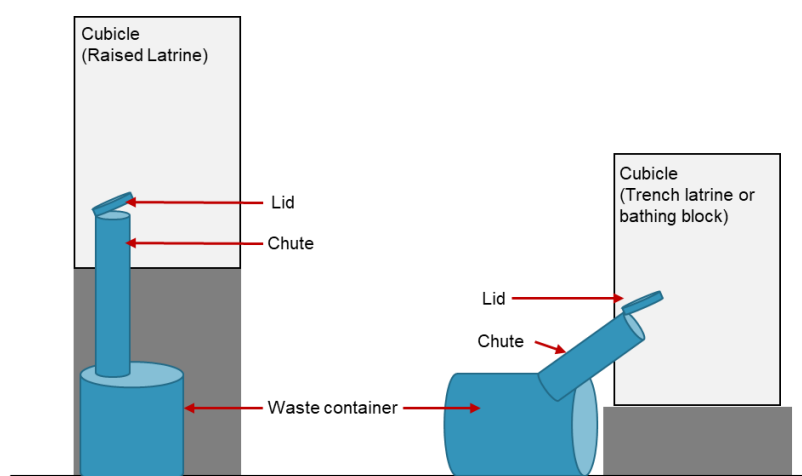

Figure 1 MHM Disposal system

4.3 Handwashing (provided in the latrines)

Handwashing can be provided using locally available products, or locally fabricated solutions.



Figure 2 Jengu handwashing unit

The template latrine designs include handwashing provision based on [Jengu handwashing units](#). These units can either be purchased as a complete unit (Figure 2) or replicated locally using the blueprint provided in Appendix B. A key feature of the Jengu system is the foot-pump-driven water outlet which facilitates **hands-free operation** for improved hygiene.

The template designs include a **60-litre tank** to store water for handwashing. This is based on:

- Daily volume per person for handwashing: 1 litre per person per day⁴
- 20 people per day per cubicle
- 3 cubicles

The 60-litre tank is sized for one day of handwashing and therefore should be replenished daily. The tank size may be adjusted to suit what is available locally, and/or taking into account requirements based on the findings of the local consultation. As a rule of thumb, the storage volume should be no less than half the estimated daily demand, but the practicality of replenishment should also be considered (e.g. if the supply is by water truck, how often does it visit).

The template designs assume the water supply for the handwashing units will be from a single tank located on the ground adjacent to the facility. With the foot-pump-driven solution there is no need to raise the tank to facilitate water flow to the outlets (e.g. for the raised latrines where the basins are located on the raised platform). If the foot-pump system is not used, the means of delivering water to the outlets would need further consideration and adaptation.

Soap should be provided for each handwashing unit. The maintenance schedule should include checking and replenishing the soap.

Separate handwashing provision is not included in the bathing block template. It is assumed water provided for bathing will also be used for handwashing.

If the template design is extended to add more cubicles, additional handwashing units may be required. There should be least one handwashing unit for every five toilets.

4.4 Bathing Provisions (in the Bathing Block)

The template designs are based on bathing by standing in a shower tray and using water from a bucket. This is based the expectation that a local water network connection will typically not be available.

A 20-litre bucket with scoop should be provided for each cubicle [three buckets + scoop for a standard 3 cubicle block].

The shower tray in the template design is based on a premade plastic tray manufactured by Butyl (Figure 3), which is available from the Emergency Response Unit list. The product sheet for the Butyl shower tray is provided in Appendix B. This could be substituted with a locally available product, or locally fabricated solution, of equivalent size and quality.



Figure 3 Shower tray used in template designs: *Butyloo-SP XPHABS* (1200x800x45mm)

⁴ Based on the upper value from Sphere which indicates 0.5 – 1 litre per person per day is required for handwashing

The tray incorporates a **90mm diameter waste outlet**.

To prevent hair and other debris entering and blocking the pipes, a **sieve should be placed across the outlet**. The sieve could be a ready-made product such as the stainless-steel example shown in Figure 4, or fabricated using locally available materials. Checking and cleaning the sieves should be included in the maintenance schedule, and users could also be asked to clean the sieve after each use.



Figure 4 Example of hair sieve for shower by Wenko

4.4.1 Bathing Greywater Collection

The greywater from bathing is drained with a discreet and simple pipe system. The shower drain connects to a 40mm diameter P-trap to prevent odours in the facilities. The greywater from the showers will pass through a 40 mm PVC pipe to a main 90 mm PVC pipe (both following a 1:50 gradient) that will convey the water to be disposed. The greywater disposal method will depend on the site conditions and is discussed further in Section 5.5.

4.5 Greywater Disposal

Greywater Definition In the context of this manual, greywater refers to water discharged from handwashing and bathing units. It does **not** include water from latrines.



Discreet drainage is essential in the context of MHM Friendly design. Social and cultural taboos around visibility of blood mean that consideration must be given to ensuring there is no real or perceived risk of red-coloured water being seen discharging from the facility. Specific recommendations relating to this are included in the guidance below.

The template designs do not include details of the greywater disposal system because the appropriate solution will be very context specific. Therefore to complete the installation, **the field team must assess the local conditions, identify the appropriate greywater disposal solution, and procure and install the necessary components**. This section provides guidance to inform this process:

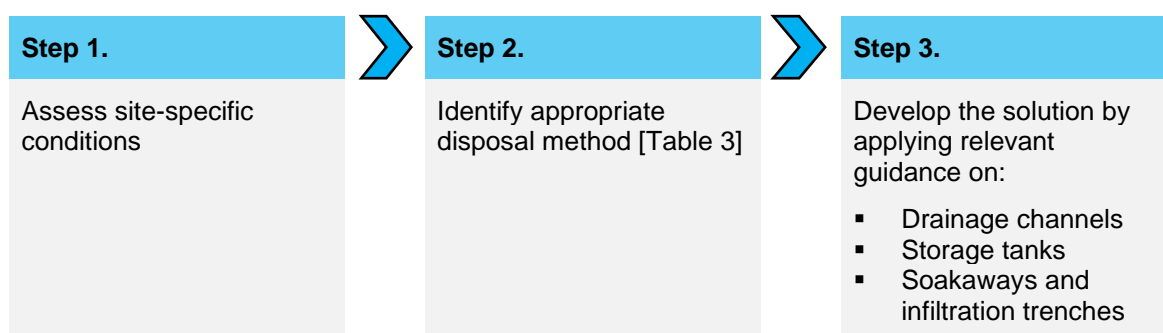

Step 1. Assess the site-specific conditions

During the site planning and selection stage (see Section 4), the site team should identify if:

1. There is potential to locate the facility in proximity to an existing drain.
2. The ground permeability is favourable for an infiltration-based solution (see Appendix A for further guidance).

Step 2. Identify appropriate disposal method

Table 3 provides guidance on which disposal method to select according to the site-specific characteristics and source of greywater.

Table 3 Guide to selecting greywater disposal method

	Greywater disposal method by source	
Site Condition	Source: Handwashing Unit	Source: Bathing Unit
Existing drain available	Connect directly if viable. However this may not be feasible as the hose for greywater connection is small and short, and the outflow is relatively small. But the site team may be able to adapt. Otherwise – select a solution for permeable or non-permeable ground as appropriate.	Connect the discharge to the existing drain. Preferably this should be using a pipe (assess the distance and procure the requisite length of piping) but if this is not feasible, and/or the distance is short, it may be by a covered channel/trench.
No ground permeability	Discharge to a storage tank which is periodically emptied. This may be integrated into the maintenance plan and coordinated with replenishing the handwashing water supply.	The discharge volume from bathing will be substantially larger than handwashing and it will probably be impractical to manage with a storage tank that must be emptied. Therefore if an infiltration solution is not viable it will be imperative to site the facilities with access to an existing drain system.
Good* ground permeability	Discharge to a soakaway or infiltration trench.	Discharge to a soakaway or infiltration trench
Poor* ground permeability	Because the discharge volume from the handwash units is small, direct infiltration is likely to be viable even when ground permeability is poor.	Discharge to a soakaway or infiltration trench, with the addition of an intermediate tank to attenuate (slow) the discharge rate to match the ground absorption capacity.
*For the purpose of this table 'good' and 'poor' ground permeability effectively refers to how well the soil infiltration rate matches the greywater discharge rate – and therefore is indicative of whether disposal by infiltration may be viable and what design features may be necessary to facilitate it (e.g. use of intermediate storage tank). See section 5.5.4.1 for guidance on assessing permeability.		

Step 3 Develop the solution by applying relevant guidance

After identifying the disposal method refer to the relevant guidance notes in the sub-sections below to develop and implement the solution.

4.5.1 Greywater discharge rates

The handwashing discharge volume will be proportional to the handwashing supply volume, so for the template designs this is 60 litres per day.

The showers will generate a much greater volume of greywater in comparison to the handwashing units, and therefore greywater disposal from the shower block requires more detailed consideration. The Sphere Standards estimate 2-6 litres/person/day for hygiene practices, which reflects the level of variability according to the context specific conditions. A context specific assessment is recommended to estimate the discharge volume. However, in the absence of this assessment, considering that the bathing facilities have been designed for 60 users to bath and also to wash reusable menstrual pads and small pieces of clothes such as underwear, it may be conservative to assume 6 litres/person/day.

4.5.2 Connection to an existing drain

In sites where infiltration is not an option, such as high groundwater levels or ground with very low permeability, the main pipe can be extended to the nearest drainage course or sewer where the greywater can be disposed. As mentioned before, discreet drainage is essential. If the water is taken to an open channel or drain, it is recommended to cover the first few metres around the discharge point, allowing travel time for the greywater from the showers to blend with the water in the channel (Figure 5).



Covered channel in Cox's Bazar (IOM, 2018c).

Figure 5 Example of a covered drainage channel in Cox's Bazar

4.5.3 Discharge to a greywater storage tank

This method is intended for conditions where ground permeability is too low for an infiltration approach and requires that the storage tank is removed and emptied regularly. This is only likely to be viable for the handwashing units which generate a much smaller volume of greywater in comparison to the bathing units.

The size of the storage tank will depend on how frequently collection can occur. The discharge volume will be proportional to the handwashing supply volume, so for the template designs this is 60 litres per day.

The location the tank is taken to for emptying should be away from general view. And if this is into an open channel or drain, as described previously the first few metres from the disposal point should be covered to allow time for the water from handwashing to blend with the runoff water.

4.5.4 Discharge to a soakaway or infiltration trench

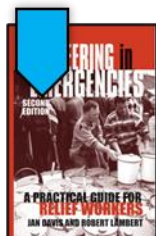

RedR's *Engineering in Emergencies*⁵ provides detailed guidance on disposal of sullage (greywater) by infiltration in Section 10.5. Some of the key principles are noted below but the RedR guide should be referred to for more detail.

Additional guidance can be found in the WEDC⁶'s manual on Emergency Sanitation⁷ [Chapter 10 Wastewater Management](#).

4.5.4.1 Assessing permeability and infiltration rate

Understanding the level of permeability and infiltration rate is important; firstly to determine whether an infiltration-based discharge method is viable; and secondly to inform the subsequent design of the system.

The greywater must be released into the ground at a flow rate that matches the soil characteristics. Assessing infiltration rates is a specialist subject. However, to assist the field engineers a method for a rudimentary assessment is provided in Appendix A.

⁵ Davies, J. and Lambert, R., 2002, *Engineering in Emergencies: A practical guide for relief workers*, Second Edition, London: ITDG Publishing in association with RedR

⁶ Water, Engineering and Development Centre (WEDC), Loughborough University

⁷ Harvey, P.A., Baghri, S., Reed, R.A., 2002, *Emergency Sanitation: Assessment and Programme Design*, WEDC, Loughborough University, UK.

4.5.4.2 Water quality control

It may be appropriate to strain the greywater prior to discharge, to mitigate the soil pores becoming blocked due to solids in the greywater. This may be done using a grease trap such as the example in Figure 6.

In this context, the use of a grease trap could serve an additional purpose of slowing the rate of discharge, which may help mitigate situations where the ground infiltration rate is not quite adequate to cope with the rate of discharge from the bathing or handwashing units. This may remove the need for an intermediate storage tank, or at least reduce the size of that tank.

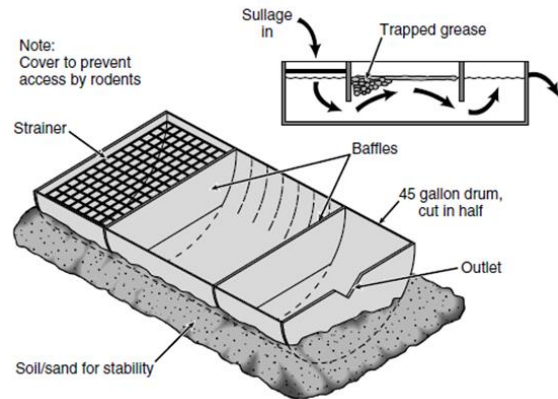

Figure 6 A simple grease trap.
From *Engineering in Emergencies* (RedR, 2002)

4.5.4.3 Type of infiltration

Soakaway

To address the need for discreet drainage, the soakaway should be covered, like the example shown in (Figure 7).

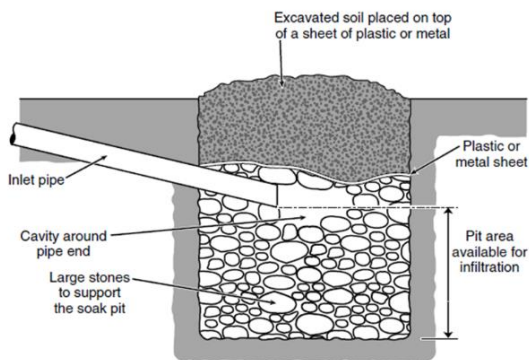

Figure 7 Covered soakaway.
From *Engineering In Emergencies* (RedR, 2002)

Infiltration Trench

When a large area of infiltration is required, or where ground conditions are not favourable for pit excavation, an infiltration trench may be the preferred solution (Figure 8).

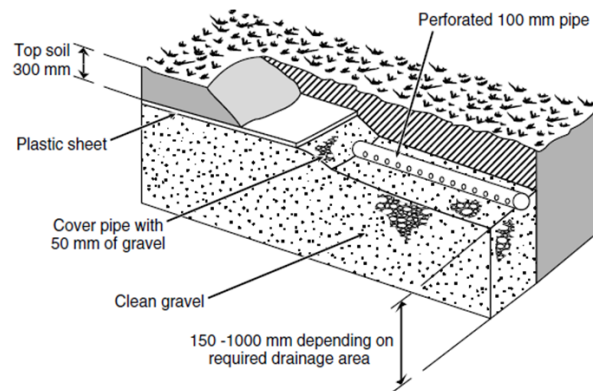

Figure 8 Infiltration trench.
From *Engineering In Emergencies* (RedR, 2002)

4.5.4.4 Intermediate tank on soakaway

If the discharge rate from the handwash/bathing units is greater than the capacity of the soil infiltration rate, an intermediate tank can be used to control the flowrate (Figure 9).

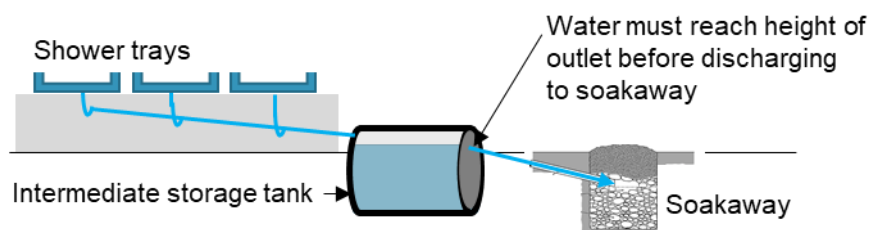

Figure 9 Intermediate storage tank to attenuate greywater discharge rate

The tank should be sized through calculation informed by the assessment of the discharge volume vs the ground infiltration rate; and take into consideration any beneficial attenuation provided by a grease trap. As an estimate, the tank volume should be equivalent to at least 1.5x the daily water consumption of the handwashing/bathing units. This is based on sizing the system to allow the tank to accumulate and slowly release over 24hours a volume equivalent to the daily discharge, with additional margin allowing for variation in the daily water use rates.

For the template latrine designs (where the greywater source is the two handwashing units), this means a tank size of 90 litres (60litres x 1.5). However, it is anticipated the low discharge rate associated with handwashing will not necessitate the use of a storage tank, even in locations with poorer ground permeability.

The water use rate in the bathing units will be highly dependent on local hygiene practices – so consultation with users is recommended to inform estimation of the amount of water used per day. Table 4 provides the indicative tank sizes for different water use rates, based on 60 users and the estimated tank size of 1.5x consumption.

Table 4 Greywater storage tank volumes discharge from bathing units

Water use for bathing (l/p/day)	Number of people	Volume of water used at bathing units (litres)	Size of greywater storage tank (litres)
2	60	120	180
3	60	180	270
4	60	240	360
5	60	300	450
6	60	360	540
7	60	420	630
8	60	480	720
9	60	540	810
10	60	600	900

4.6 Solid Waste Collection & Disposal (Latrines)

4.6.1 Latrine types

The template designs include two types of latrine:

Trench Latrines When ground conditions permit, the latrine structure can be kept close to ground level, with the waste captured in a trench below the structure.

The advantage of this approach is a more compact footprint as the need for long access ramps is mitigated, and this structure may also be more resilient in locations with high winds.

In an acute emergency response scenario, to aid speed of installation, the trench is often sized just for the duration of the emergency response and the facility is then relocated when the trench is full. To enable desludging a more robust trench specification is required, which may be in conflict with the need to quickly establish the facility in the acute response stage.

The template design for the trench latrine is based on adapting the **UNHCR Emergency Trench Latrine (D401-/2015a)** to incorporate MHM and Accessibility features.

Raised Latrines An alternative to the trench solution is to install the latrines on a raised structure with tanks below for waste capture.

A key advantage of the raised latrines is the ability to desludge which can extend the service life beyond the acute emergency response phase.

Another advantage is mitigating the need to excavate a trench which can be onerous. As all the components of the facility are above ground it may be easier to implement upgrades to extend the life of the block beyond the emergency response phase, or simply to respond to changing use patterns (e.g. adding storage tanks to expand capacity).

However the raised platform creates the need for a substantial ramp for inclusive access and may make the structure more susceptible to high winds.

The template design for the raised latrine is based on adapting the **UNHCR Emergency Raised Desludgable Holding Tank Latrine (D405-/2015a)** to incorporate MHM and Accessibility features.

4.6.2 Waste storage volume – Trench Latrines

The lifespan of this design is associated with the trench capacity. Generally, this design should be used on sites where there is enough land to dig another trench when the initial one fills within 5 months; and/or in settlements where there is a plan to move to a more permanent solution after the initial emergency response (such as household latrines or communal VIP desludgable pit latrines).

The template design maintains a 2m trench depth as recommended in UNHCR Emergency Trench Latrine (D401-/2015a). This is an optimal depth to maximise the use of the trench whilst prioritising health and safety. Before selecting the trench solution, trial pits should be dug to understand the soil characteristics. The ground must be soft enough to dig, but firm enough to be self-supporting. It is important to consider that pits dug in clay in the dry season may appear stable, but they can quickly collapse when the clay becomes wet following rain or a rise in the groundwater table. If there is enough evidence of strong ground conditions and safe construction is ensured, the depth of the trench could be increased to 2.5m. If the soil characteristics require the temporary trench latrine to be fully lined (unstable soils), consider strongly using another (raised) latrine technique.

Fully lining the trench will affect the speed and cost of construction, and it will limit the pit size (which may make it less appropriate for a toilet with a high number of users). Therefore a lined trench is not expected to be an appropriate temporary solution for an acute emergency response.

Notwithstanding the above comments regarding fully lining the trench (which is not recommended); it is recommended for deep trench latrines (over 1.2 m) to be lined for the first 0.5 m from the top (the most unstable area) to ensure stability. Further guidance on this can be found in WEDC's Excreta Disposal in Emergencies⁸, [Chapter 7 - Technical Design Information](#)

4.6.3 Trench Decommissioning

For decommissioning, the trench should be backfilled with 0.5m depth of earth to allow for settlement; so the waste level should be monitored and the trench closed when this clear space remains. Approximately 10 kg of lime may be used per cubicle to help neutralize the pH of the pit and assist in decomposition and drying. Where possible, quick growing plants or trees should be planted on the site to assist with drying of the pit. To ensure safe handling of lime please follow the [recommendations of the European Lime association \(EuLA\)](#).

Prior to backfilling, the superstructure should be removed and if this is done carefully it can be reused in a new trench location.

4.6.4 Waste storage volume – Raised Latrines

The template design has been adapted to fit larger tanks than those used in the UNHCR Emergency Raised Desludgable Holding Tank Latrine (D405-/2015a). This was based on ensuring compatibility with a range of tank sizes, and also to reduce the frequency of the desludging operations.

A review of tanks available in a number of locations found a minimum tank height of 1100mm should be assumed. A 200mm deep butyl collar will connect the tank to the squatting plate opening to ensure the connection is sealed. The total minimum clear height to accommodate the tank and collar beneath the platform is therefore set to 1300mm.

To limit the frequency of desludging, a larger tank is desirable. However, increasing the platform height to accommodate a larger tank means the length of the ramp must also increase (to maintain the maximum slope for compliance with accessibility requirements), which can substantially increase the overall footprint of the facility.

To mitigate this, the template design has adapted the UNHCR platform to accommodate two different heights:

- the main platform and accessible cubicle are set to 1300mm which allows for a waste storage tank of at least 500 litres, whilst maintaining a reasonable length ramp.
- the floor of the general cubicles is set to 1450mm, which allows for a tank of at least 1000litres.

The review of typical tank sizes found some examples of 1000litre that were around 1100mm high. If these tanks are available in the project location they can be used to serve all three cubicles and the whole platform (including the general cubicles) can be set to 1300mm height. The template design could easily be adapted by extending the configuration of the accessible cubicle floor and structure across the general cubicles.

The template design assumes excavation of the ground is not possible. However, if soil conditions allow, tanks higher than 1100mm could be partially buried in the ground. In this case, it is important to still leave access to the desludging flange if it is at the bottom of the tank.

⁸ Harvey, P. 2007, *Excreta Disposal in Emergencies: A Field Manual*, WEDC, Loughborough University, UK

4.6.5 Desludging Approach

The solid waste tank specification for the raised latrines allows the tanks to be desludged through a bottom flange, or through a lateral access in the top. Desludging through the latrine pan/squatting plate is avoided primarily because of the health risk associated with potential spillage, and also because it can cause damage to the facility.

Typically, trench latrines should not be desludged as there is high risk of collapse when the solids are removed. If it is known prior to construction of trench latrines that desludging will be required (i.e. the facility will need to operate beyond the design capacity of the trench) then the trenches should be fully lined. This option should be considered alongside the alternatives – which are to relocate the latrines once the trench is full (reusing the superstructure) or opt to install raised latrines instead.

When siting the latrines, allowance should be made for the desludging truck to access and manoeuvre.

4.7 Ventilation

Ventilation in the cubicles is needed for olfactive comfort, air renewal and to keep the installation dry. This is achieved with openings at the top of the cubicle over the door and on the external wall, which should be covered with mosquito nets to avoid the entrance of vectors and support the feeling of privacy.

4.8 Surface water management

It is important to take measures to avoid rainwater entering the facilities or stagnating around them.

To avoid water on the platform, the floor from the platform and the cubicles should be graded 1:100.

The planks on the ramp should be installed with some gaps (i.e. not flush to each other) so that water may drain through rather than flow down the ramp.

4.9 Rainwater management

The rainwater from roof of the cubicles should be collected with a simply made gutter (such as 80mm PVC pipe cut) and conveyed to a small drainage ditch around the facilities, which should be at least 30cm. Note that this is not detailed in the template designs because the gutter sizing will need to be based on local rainfall data.

If the climate is favourable, a rainwater harvesting system could provide water for use such as irrigation. If a rainwater harvesting system is installed, the water from the first flush system and the tank overflow should be drained to an appropriate discharge point (i.e. a drainage ditch or a soakaway). More details on rainwater harvesting can be found in the Appendix A.

4.10 Lighting

Lighting is an important consideration with respect to both usability and safety. Wherever possible – use of natural light should be optimised, to minimise/eliminate the reliance on electrical lighting during the day. But provision of artificial lighting may still be necessary to facilitate safe use of the facility at night. The lighting solution should be developed in consultation with the user groups as there may be conflicting concerns – such as the risk of creating a ‘gathering place’ if the area around the block is well-lit. Guidance on lighting for toilets can be found here:

<https://www.oxfamwash.org/en/lighting>

<https://www.oxfamwash.org/en/sanitweaks>

5 Structure Performance Specification

This section describes the performance specification of the facility structures. This **must be reviewed on a case-specific basis to ensure the performance is suitable for context**. If the conditions for the design-case vary from those applied to the template, the information in this section can be referred to for guidance on how to evaluate and adapt the design criteria.

5.1 Structural Design Codes

The structural design is generally carried out in accordance with the Eurocodes BS EN 1995-1-1, except where noted otherwise. The IStructE Manual for the design of timber building structures to Eurocode 5 has also been referenced throughout.

5.2 Design Life

The facilities shown in this manual have been designed for an acute, initial first phase of the emergency response. They are meant to be **temporary**, with a lifespan of 4-5 months, and fast to build. After that, it is generally recommended to move to more permanent constructions, preferably at a household level.

However, it is recognised that facilities constructed in emergency conditions often continue to be used beyond the emergency phase. **So for the purpose of the structural design the design life is taken to be 5 years**. This was judged to be a reasonable compromise to maintain the principle of fast, cost-effective construction balanced with the need to accommodate extended use (Figure 10). Another reason to be careful of designing for extended life is the risk the resulting structure may fall under the category of 'permanent' which can have implications for planning and building permissions, and other applicable regulations.

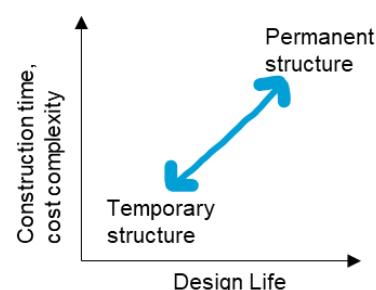

Figure 10 Implications for design life on construction and structure specification

5.3 Materials

The materials and equipment used in the designs are aligned with what is typically available in an emergency response context. However, this may vary in different countries, and therefore some local adaptation may be necessary.

5.3.1 Timber

The strength class of the timber for this design is C16 (C for coniferous) referred to in Eurocode 5 and graded in accordance with BS EN 14081. C16 refers to the ultimate bending strength which is 16N/mm² before application of safety factors for use in design. The density of the softwood is assumed to be between 4 and 6kN/m³.

Where possible the design has been limited to using standard maximum length of timber at 5.5m. The latrine and shower blocks have not been designed for use of bamboo as the timber structural material. If it is required to adapt this design to use bamboo, this should be reviewed by a technically qualified person familiar with bamboo design with specific consideration made to the design of the connections.

Timber selected for structural use should consider the following:

- Make sure timber is as straight as possible and there are no large splits.
- Make sure the grain of the timber is straight and minimise the number of knots as they are weak points in the timber.
- Timber should be properly dried to prevent it shrinking in use. Timber should be stacked to allow air flow and left at least 72 hours if it has previously gotten wet.
- Timber cut from the edge of the tree trunk cannot be used. This timber is easily attacked by insects. Timber that shows any signs of termites or any other insect attack should not be used.
- All timber (and wooden) elements must be treated against termites and insects in general, as well as against rot. Timber should be coated first with an anti-termite treatment such as borax, then with a water repellent treatment such as bitumen or Japan black before mounting. The timber must be well dried before applying the treatments.

Further information in using timber as a construction material can be found at: Timber Guidelines (<https://www.sheltercluster.org/sites/default/files/docs/Timber%20Guidelines.pdf>).

5.3.2 Plastic Sheeting

Plastic sheeting used should meet the international minimum humanitarian standards (i.e. 200g/m² 700N tensile strength, UV stabilised laminated woven or braided mesh of black high-density polyethylene between two white layers of low-density polyethylene).

The use of plastic sheeting toilet superstructures is an emergency solution and should be phased out after the first six months. Note in areas of high winds, it may be that the domed nails specified are not sufficient to prevent against tearing. In these cases, the plastic sheeting should be refixed using a spreading element such as a timber batten or larger washer (or bottle top) at each fixing.

Further information about using plastic sheeting can be found at: Plastic Sheeting (https://www.sheltercluster.org/sites/default/files/docs/Plastic%20Sheeting%202007_0.pdf).

5.3.3 Connections

The following requirements should be adhered to when making connections (see also step-by-step guidance for each template design):

- Timbers to be joined using four small wood screws per connection within a panel. Use four small wood screws per connection for each plank connection.
- Panels to be bolted together for ease of storage, assembly, disassembly, moving and reuse in new locations.
- Two bolt thread lengths have been specified in the BOQ (17cm and 22cm) to be used when connecting two timber pieces 5cm+10cm and 10cm+10cm respectively with a washer. In the step-by-step construction sequence, unless specified a 17cm bolt thread length should be used to connect panels together.

5.4 Foundations

Table 5 describes simple methods for assessment of clay soils with guideline values for safe vertical cut heights. The safe excavation of vertical cuts in clay soils is controlled by many factors and the provided values are intended as guideline values only.

It is assumed that latrine and shower blocks will be built only on competent ground conditions (i.e. those ground conditions which are either firm or stiff as assessed as per Table 5) and potential sites which do not meet these ground conditions should be reselected.

For the purposes of the structural checks on the template designs, the ground conditions are assumed to be medium dense gravel and sandy gravel to support the timber frame structure based on BS EN 1997-1.

Table 5 Guideline values for field assessment of Clays

Field Description	Undrained Shear Strength	Field Assessment	Thumbnail Penetration	Field observations
Very Soft	< 10kPa	Exudes between fingers when squeezed	>25mm	Guideline safe vertical excavation height of 0.5m
Soft	10–20kPa	Can be moulded by light finger pressure	>10mm	Unsupported trench sides bulging and collapsing at greater than 0.5m depth
Firm	20-40kPa	Can be moulded by strong finger pressure	<10mm	Guideline safe vertical excavation height of 2m Unsupported trench sides likely to remain vertical and stable up to 2m
Stiff	40-75kPa	Cannot be moulded by fingers but can be indented with thumb pressure	<5mm	Guideline safe vertical excavation height of up to 4m Unsupported trench sides remain near vertical and stable up to 4m
Very Stiff	75-150kPa	Can be indented by thumbnail	<1mm	Unsupported trench sides likely to remain vertical and stable
Hard	150-300kPa	Difficult to be indented by thumbnail	~0mm	
<p><i>Note: Stability of vertical cuts in clays are controlled by many factors; values provided here do not consider all factors and are indicative and guideline values only. Verification of specific site conditions through specialist investigation and testing should be made where possible.</i></p>				

Efforts should be made to ensure the ground around the base of the latrines is well drained to avoid the base elements becoming submerged in water. If this is unavoidable (or is discovered after the installation of the latrine), consider additional protection measures for these elements such as additional timber treatments or concrete encasement.

5.5 Wind Loading

A conservative wind pressure was taken in the analysis of the structure to ensure it can withstand large gusts. This value has been taken to be 178km/h (50m/s) in very severe cyclonic storm which equates to an applied **Basic Wind Speed of 1.5kPa**. However it is recognised that this may be too conservative for many locations and therefore Table 6 provides information to explain when the additional elements which protect against high winds are required.

Table 6 summarises the findings of the wind load analysis and potential measures to prevent overturning where applicable.

Table 6 Applicability of the Design for Different Wind Speeds

Maximum applied wind speed (m/s)	Additional elements required
< 25m/s	No additional elements requirement
> 25m/s, but <50m/s	Two options: Timber propping with 10 x 100kg sandbags placed on the furthest side from the latrine pits No timber propping with 15 x 100kg sandbags placed on the furthest side from the latrine pits
The structure should not be placed in site locations with maximum wind speeds greater than 50m/s.	

Figure 11 shows the suggested orientation for the timber props, which should be placed at every bay to give a total of 5 props. Two timber planks of the same section size (50x100mm) placed back-to-back and fixed at 150mm centres along the length create both the ground propping members and the diagonal members.

In addition a minimum of 10 x 100kg sandbags should be placed over the timber planks on the side furthest from the latrine pits.

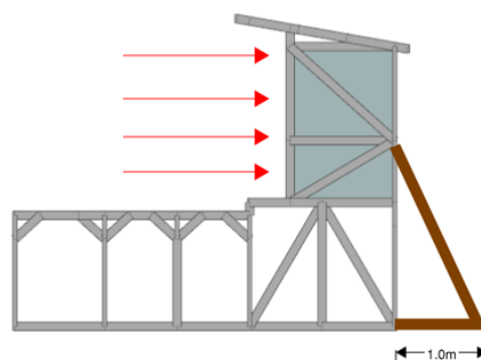
**Figure 11 Suggested orientation for timber props**

5.6 Seismic Loading

The structure is generally suitable for use in moderately seismic locations. If the structure is being implemented in an area with a seismic hazard greater than 0.3g, then additional checks for seismic loading should be carried out. These checks should use seismic hazard parameters as stated in local codes. Where no seismic codes exist, appropriate research should be sourced and referenced as the basis for seismic analysis.

Section C – Template Designs

This section provides an information pack for each of the template designs to facilitate procurement and construction, following adaption according to the guidance provided in Sections A and B.

6 Template Design 1: Trench Latrine Block

This design is based on the UNHCR Emergency Trench Latrine (D401-/2015 a).

It is a temporary MHM and disability-friendly toilet block, appropriate for sites where the ground conditions allow safe excavation, without risk of groundwater contamination. The toilet block is composed of two general cubicles and one accessible cubicle, with two handwashing units available to the users. The block is raised 30 cm to prevent water entering the trench in rainy season. Access to the toilet block is provided by a short ramp.

Key points to note prior to procurement and construction:

- Use the guidance provided in Sections A & B of this manual to carry out assessments for context specific adaption including:
 - User Consultation ([IFRC MHM Guide & Toolkit](#))
 - Site assessment (see [Site Checklist](#))
- Review the BOQ and substitute locally available materials and equipment where appropriate.
- Take note of the connection details and provide appropriate instruction to the construction team:
 - Timbers to be joined using four small wood screws per connection within a panel. Use four small wood screws per connection for each plank connection.
 - Panels to be bolted together for ease of storage, assembly, disassembly, moving and reuse in new locations.
 - Two bolt thread lengths have been specified in the BOQ (17cm and 22cm) to be used when connecting two timber pieces 5cm+10cm and 10cm+10cm respectively with a washer. In the step-by-step construction sequence, unless specified a 17cm bolt thread length should be used to connect panels together.

6.1 Trench Latrine Block Bill of Quantities

Ref	Item	Quantity	Unit	Notes
1	Timber			
1.1	Wooden Posts (4m x 5cm x 5cm) Strength class C16, Density 4 to 6kN/m3	40	pc	For screen's frame, doors' frame, handrails, ramp
1.2	Wooden Beams (4m x 10cm x 5cm) Strength class C16, Density 4 to 6kN/m3	85	pc	For raised platform structure and cubicle framing
1.3	Wooden Planks (4m x 20cm x 2.5cm) Strength class C16, Density 4 to 6kN/m3	50	pc	For floor, ramp, stairs and shelves
2	Fixings & Hardware			
2.1	Small wood screws (6mmx 150mm or equivalent No. 12 5.59mm diameter)	10.5	kg	4 wood screws at each connection location within a panel. 880 screws total
2.2	Nails (14cm Galvanized)	5	kg	To secure walking planks 2 per connection → 150 nails total
2.3	Domed Head Nails (4cm Galvanized)	4	kg	To fix plastic sheeting – every 30 cm or less. 1116 nails total
2.4	Metal Bolts and Washers (M10 x 17cm)	64	pc	To join cubicles' panels
2.5	Metallic self-closing Door Hinge (4cm x 8cm x 2mm Galvanized)	9	pc	3 per door. If they are not available use normal hinges and self-closing springs
3	Cladding			
3.1	Plastic Sheeting /Tarpaulin To meet the international minimum humanitarian standards (200g/m2 700N tensile strength, UV stabilised laminated woven or braided mesh of black high-density polyethylene between two white layers of low-density polyethylene)	91	m ²	For walls, doors, and roof.
3.2	Mosquito net	4	m ²	For ventilation gaps in cubicles
4	WASH Components			
4.1	Self-Supporting Plastic Latrine Slab 1200x 800mm – Evenplate product	3	pc	For general and accessible toilets.
4.2	Toilet seat - ICONO	1	pc	For accessible cubicle
4.3	150 mm diameter pipe	2	m	For the disposal system
4.4	60 L tank	1	pc	Water storage for handwashing
4.5	Jengu Handwashing Unit	1	pc	To be deployed or replicated locally
4.6	Jengu Handwashing Unit Accessible	1	pc	To be deployed or replicated locally
5	Fixtures & Fittings			
5.1	Door locks – door bolt type 4cm long	3	pc	For doors in the 3 cubicles
5.2	Wooden Grab Rails and Door Handles (Minimum 500mm Length)	9	pc	For the door both sides and one inside each cubicle

Ref	Item	Quantity	Unit	Notes
6	Accessories			
6.1	20 Litre Bucket with lid and ladle	3	pc	One in each cubicle to provide water inside
6.2	Hanging bell	3	pc	One in each cubicle
6.3	Hooks	6	pc	Two in each cubicle
6.4	Padlock	3	pc	To lock the bins of the disposal system
6.5	300x 800 mm mirror	3	pc	One in each cubicle
6.6	150 mm diameter lid (for top of 150mm pipe)	3	pc	For the disposal system
6.7	150L tank	2	pc	For disposal system

ANCHORING OF LATRINE BLOCK FOR WINDSPEEDS >25M/S

Requirement for the following depends on site conditions:

Ref	Item	Quantity	Unit	Notes
A 1	Option 1: Timber propping			
A 1.1	Wooden studs (4m x 10cm x 5cm) Strength class C16, Density 4 to 6kN/m ³	10	pc	Timber propping
A 1.2	Small wood screws (6mmx 150mm or equivalent No. 12 5.59mm diameter)	200	pc	
A 1.3	100kg sandbag	10	pc	
A 2	Option 2: Sandbags only			
A 2.1	100kg sandbag	15	pc	

Key Notes on the BOQ:

All items may be substituted with alternatives (ready-made or locally fabricated) provided they are of equivalent performance and size. The field team is responsible for checking details of dimensions and connections for compatibility with the facility as designed, making any adaptations required to accommodate the substitution.

The **strength class of the timber planks** for this design is C16 (C for coniferous) referred to in Eurocode 5 and graded in accordance with BS EN 14081. Please refer to Section 9.3.1 for further information on the structural specification of the timber required for the latrine block.

Additional items requiring local / site specific selection

The field-team should consider site specific conditions that might require additional elements to be specified and procured. Blank rows are included at the end of the BOQ to allow for these additions. This may include for example:

- **LIGHTING:** The lighting solution has not been included as it should be specific to each site, and developed in consultation with the user groups. The field team will need to consider what elements to procure regarding lighting. Further guidance is referenced in section 5.10 of the manual.
- **PLUMBING:** The design considers provision of water through buckets. It does not incorporate elements for water connection. If the field team wish to incorporate another form of water supply, they will need to consider what additional elements are required to be procured
- **MATERIALS FOR GROUND PREPARATION:** The field team should determine if additional preparation is required and procure the necessary labour and materials.

6.2 Trench Latrine Block Architectural Drawings and Visualisations

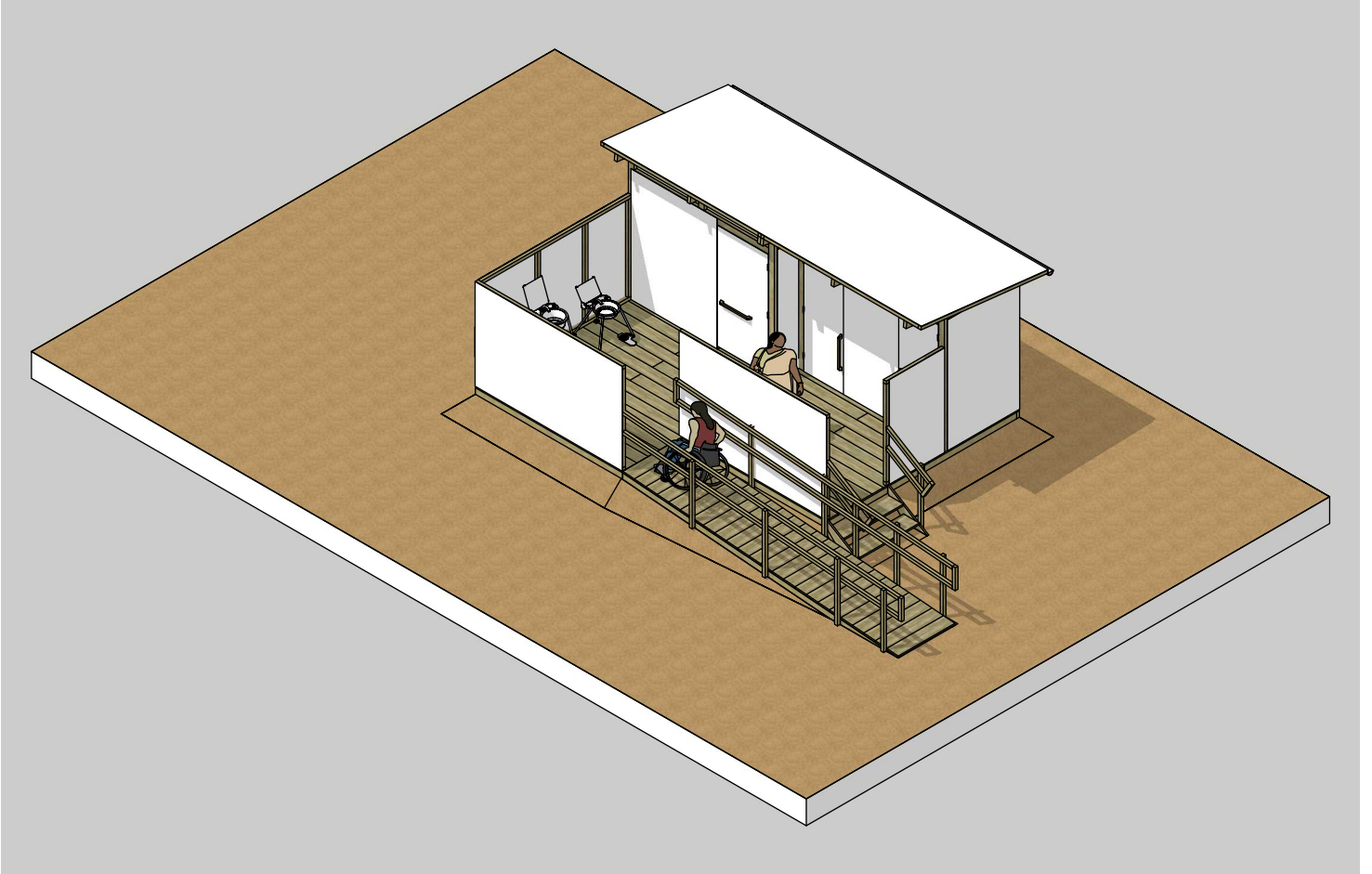

Trench Latrines Block
Isometric view

Latrine Cubicle
Plan 1:50

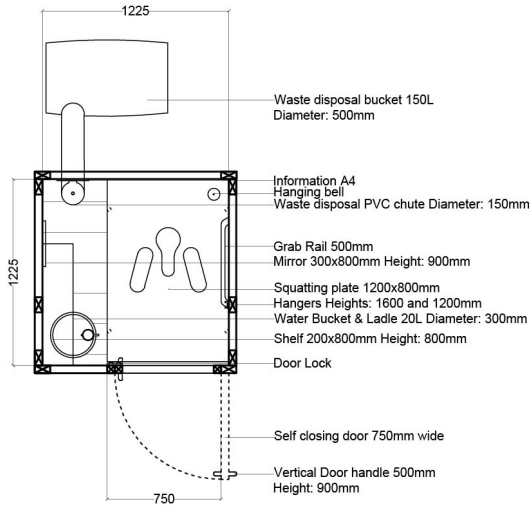

Latrine Cubicle PRM
Plan 1:50

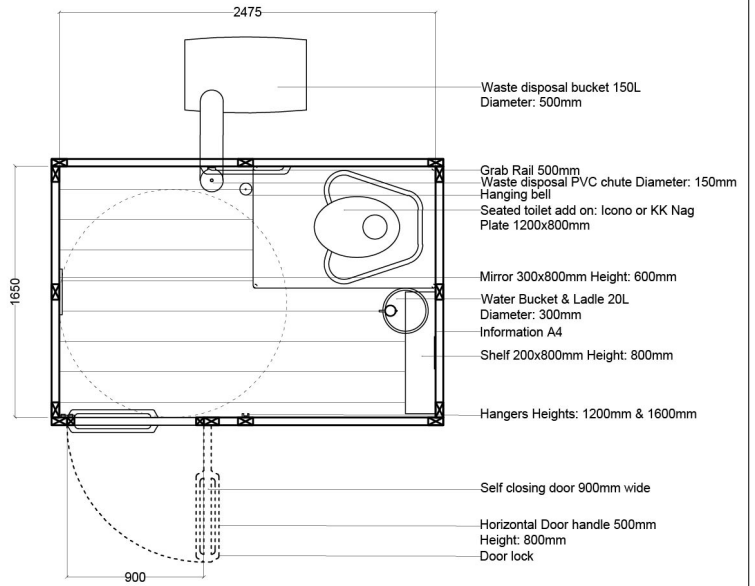

Latrine Cubicle
Section 1:50

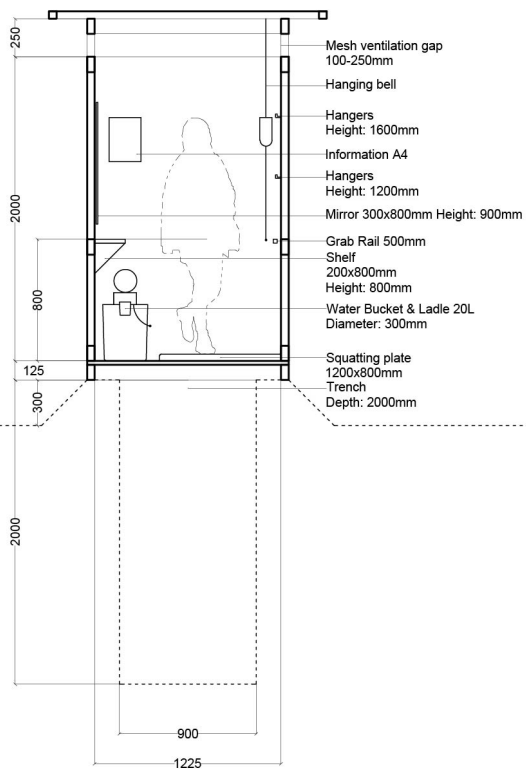

Latrine Cubicle PRM
Section 1:50

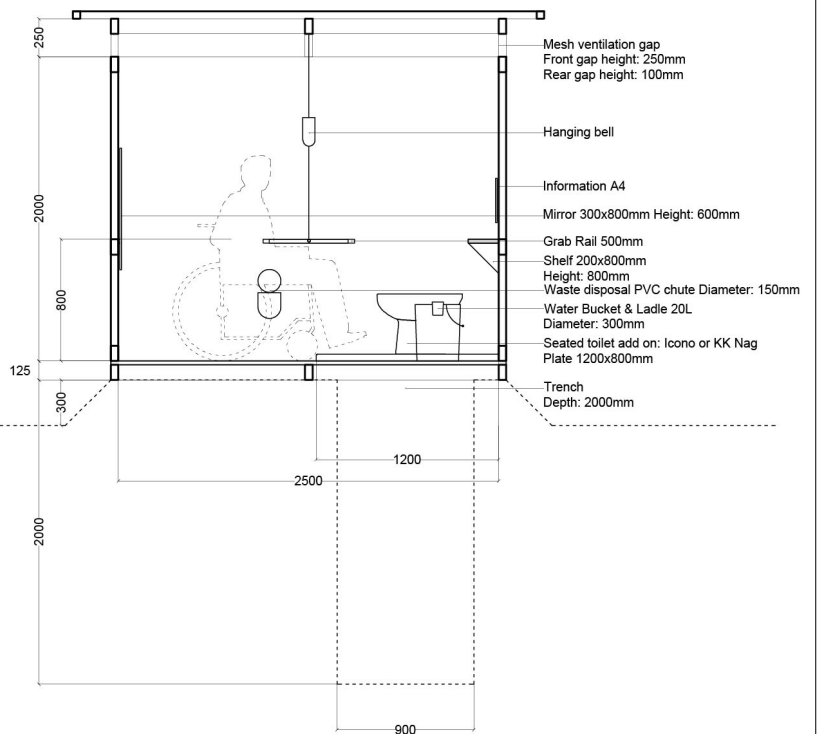

Trench Latrine Cubicles
Plan & Section

General Plan

1:50

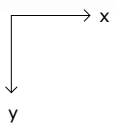
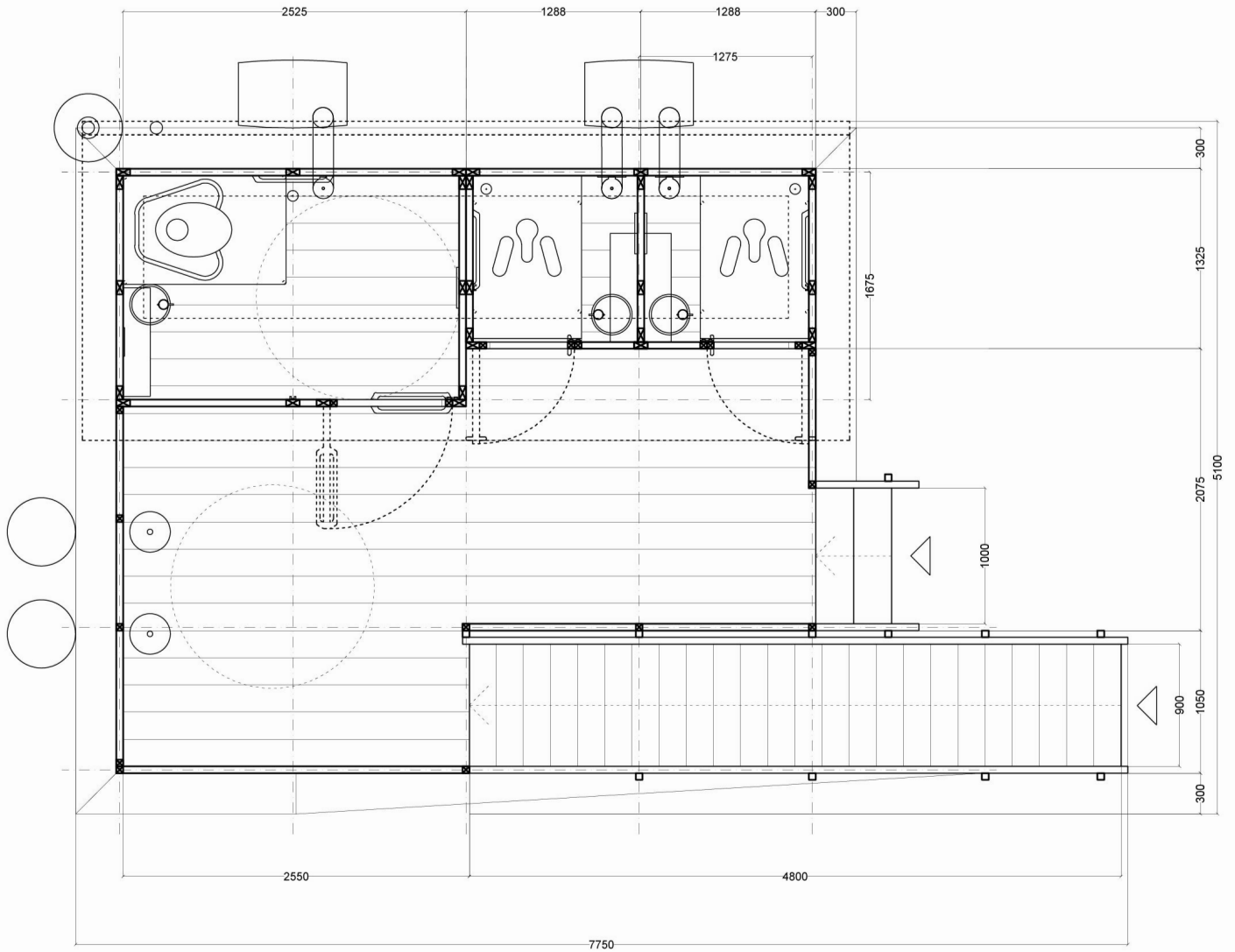

Trench Latrines Block Plans

Print to size A4

MARCH 2022

Support Structure Plan

1:50

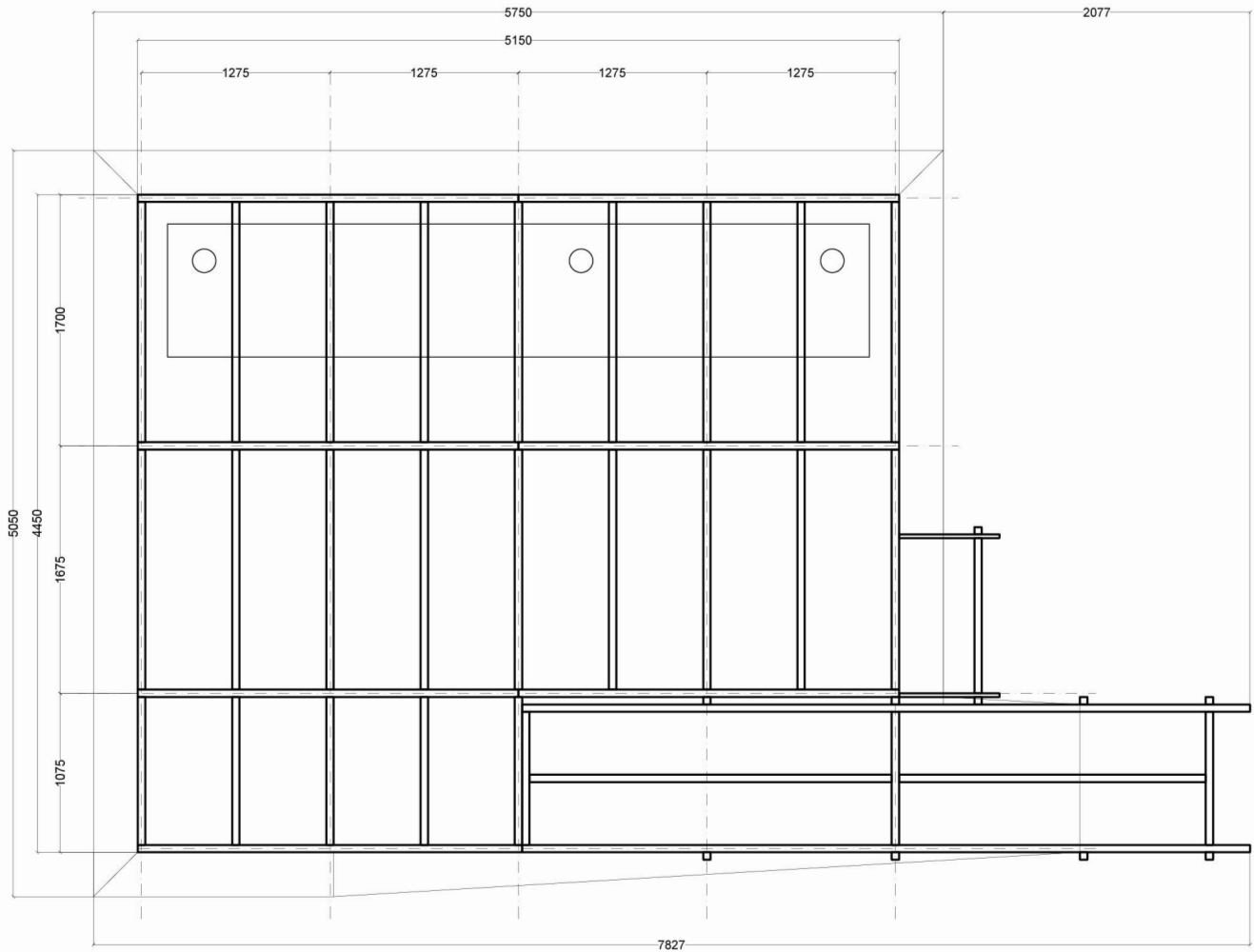

Trench Latrines Block

Plans

Print to size A4

MARCH 2022

Front View

1:75

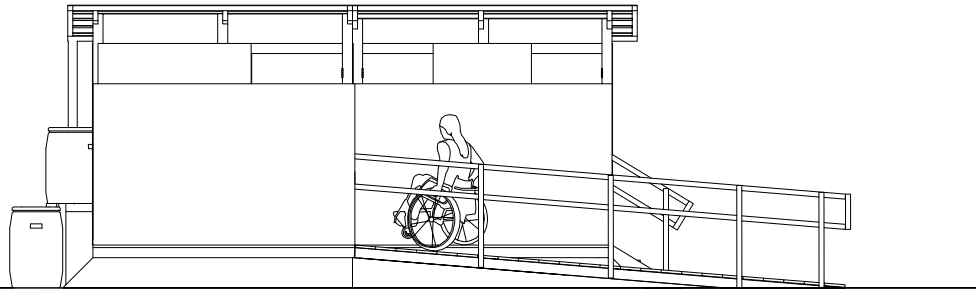
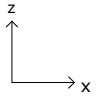

Rear View

1:75

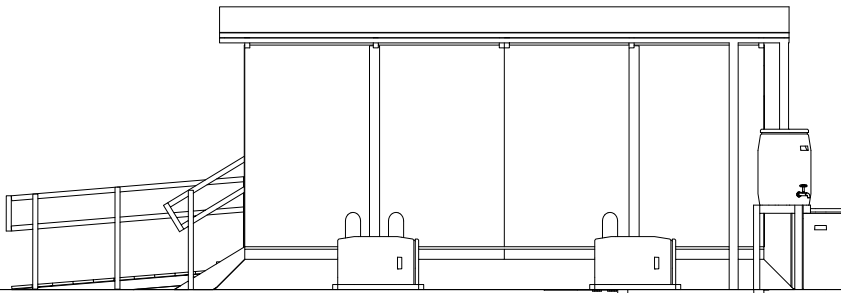
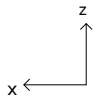

Side View

1:75

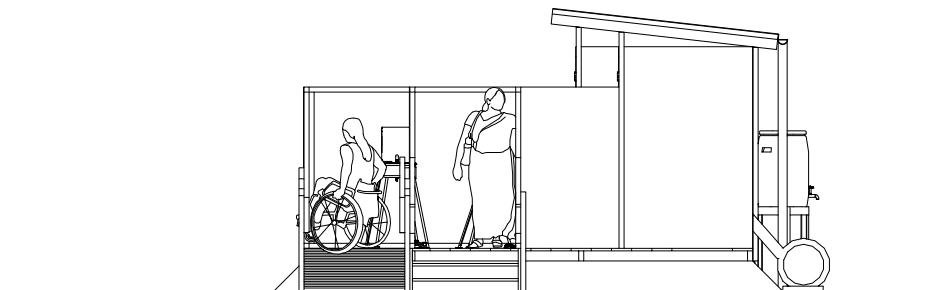
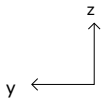

Trench Latrines Block

Elevation Views

Print to size A4

MARCH 2022

Front View

1:75

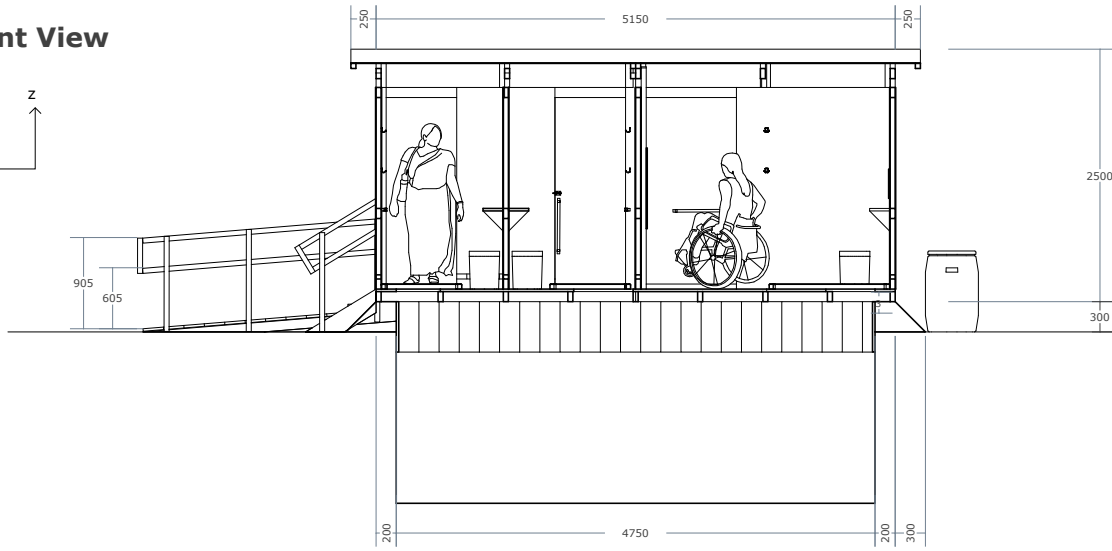
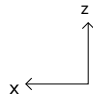

Rear View

1:75

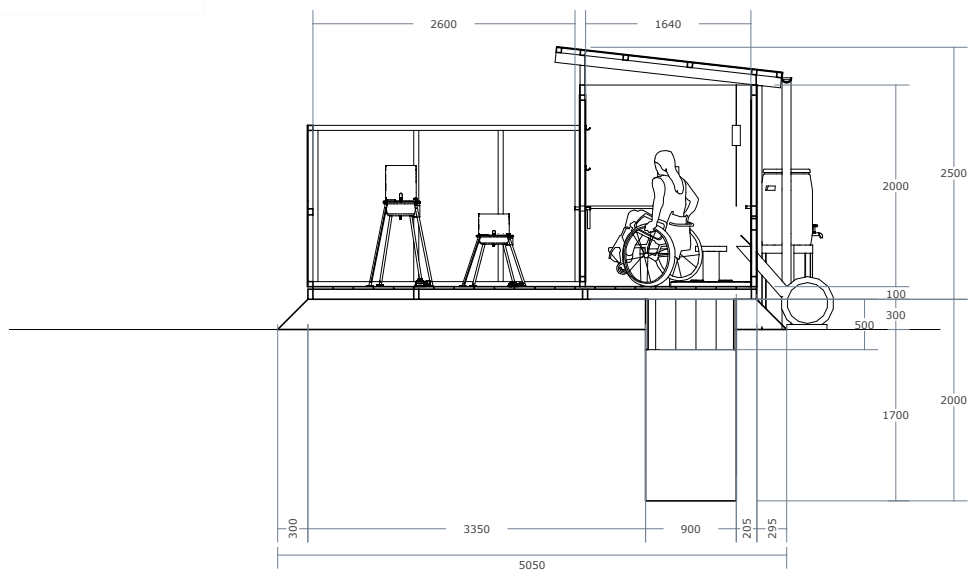
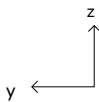

Ramp & Stairs Elevation

1:75

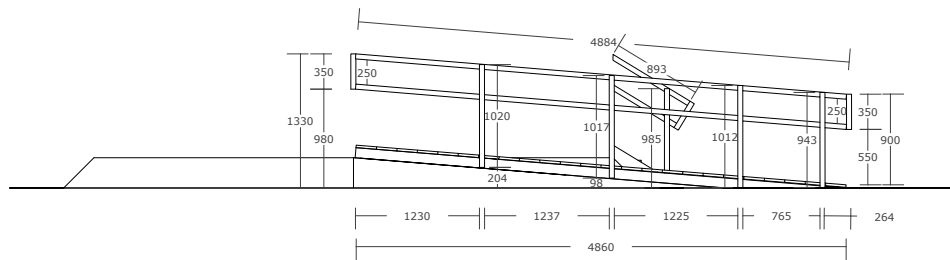
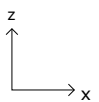

Trench Latrines Block

Section Views

Isometric Front View
1:100

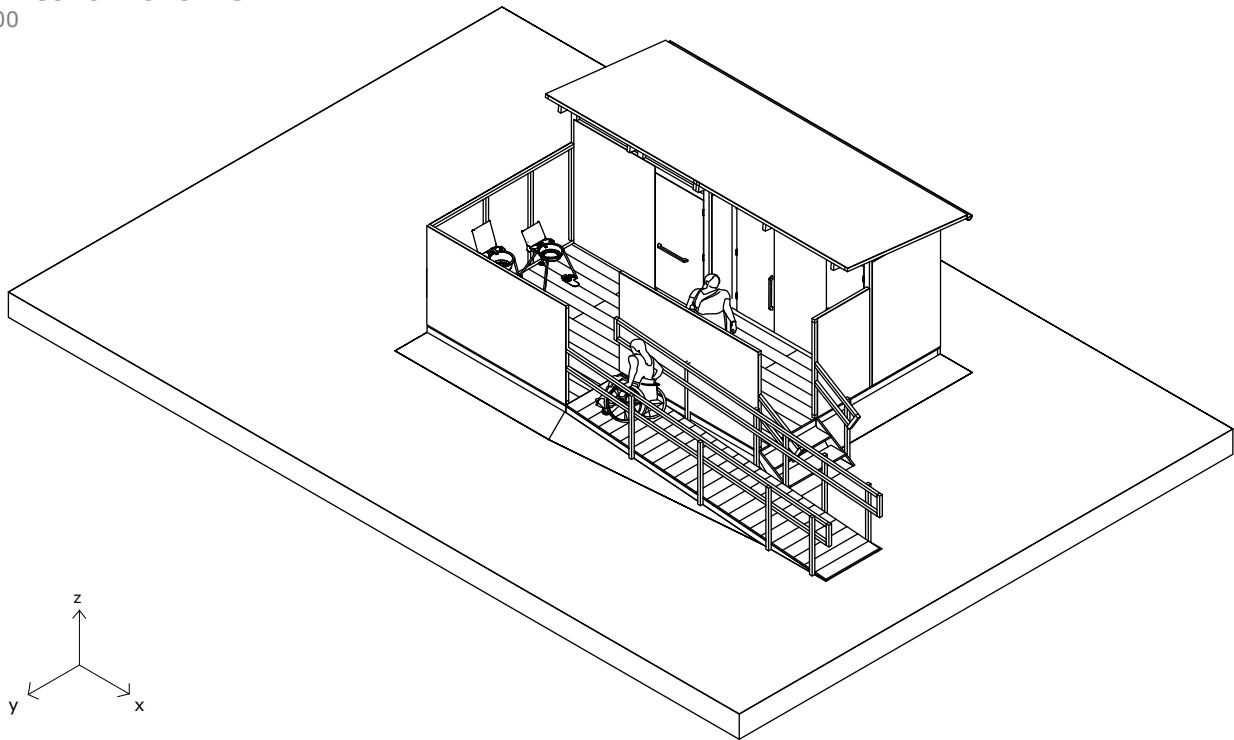

Trench Latrines Block
Isometric views

Print to size A4

MARCH 2022

Isometric Below View
1:100

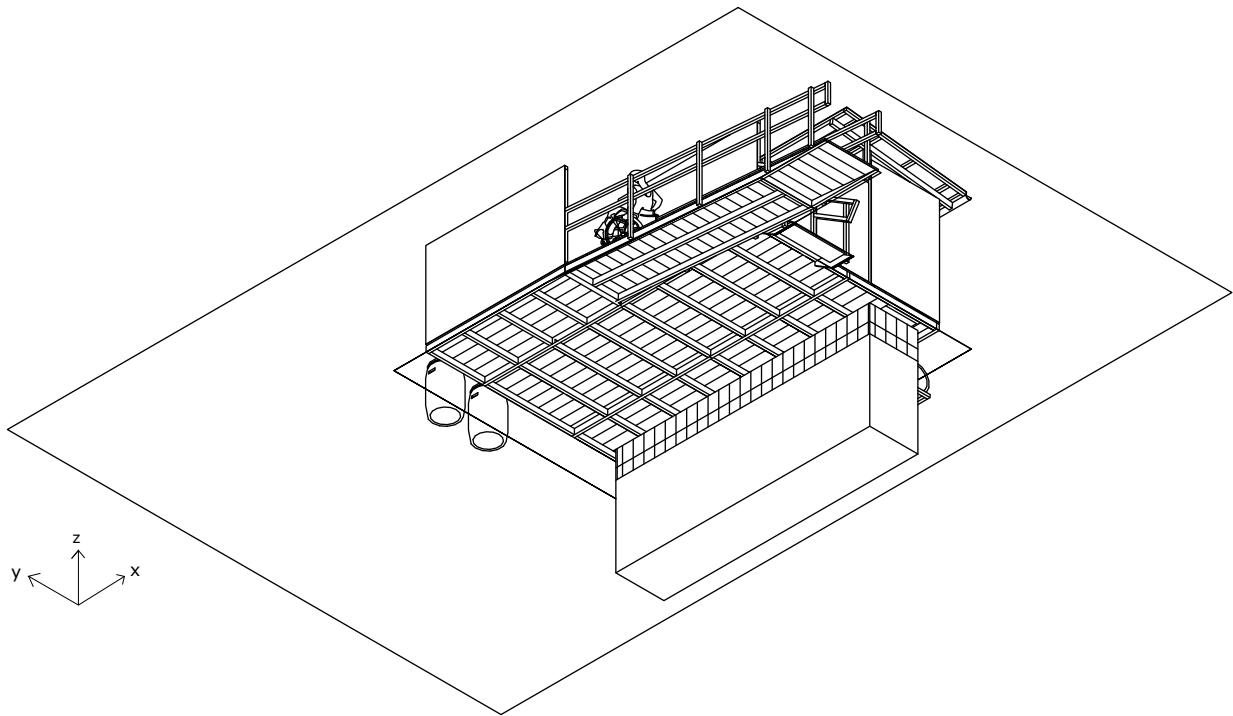

Trench Latrines Block
Isometric views

Print to size A4

MARCH 2022

6.3 Trench Latrine Block Panel Lists & Diagrams

Panel List

Trench Latrine Block - TL

Panel reference code	Number required
TL 41	1
TL 51	2
TL 52	2
TL 53	1
TL 54	3
TL 55	1
TL 61	1
TL 62	1
TL 63	1
TL 64	1
TL 71	2
TL 72	2
TL 73	1

Plank List

Trench Latrine Block - TL

Plank reference code	Section	Length (mm)	Number required	Reference
TL P01	50x100	500	120	Trench shuttering
TL P02	50x100	5000	2	Trench shuttering
TL P03	50x100	800	2	Trench shuttering
TL P04	50x100	2575	7	Platform
TL P05	50x100	1625	18	Platform
TL P06	50x100	1000	5	Platform
TL P07	25x200	820	2	Stairs
TL P08	25x200	1050	2	Stairs
TL P09	50x100	2000	2	Cubicle frame
TL P10	50x100	2015	1	Cubicle frame
TL P11	50x50	1050	10	Ramp
TL P12	50x50	Refer to ramp elevation		Handrail
TL P13	50x100	2250	6	Roof

Trench Latrines Block

Lists of panels and planks

Print to size A4

MARCH 2022

Ramp Frames
Timber 50x100mm - 1:50

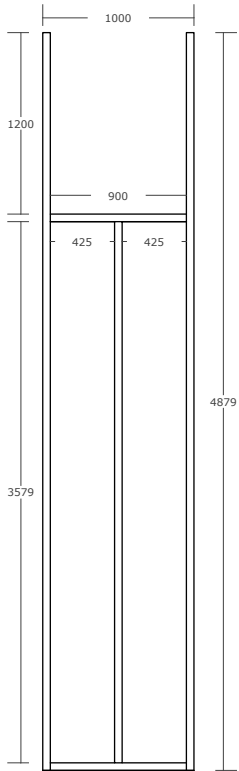

TL_41

Platform Frames
Timber 50x100mm - 1:50

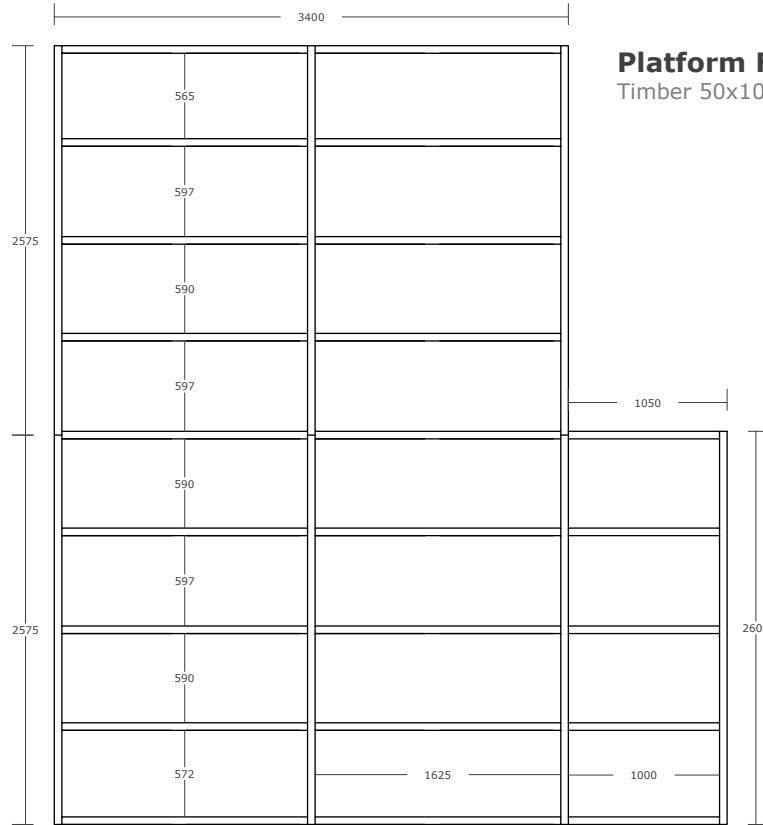

Ramp Floor Boards
Timber 25x200mm - 1:50

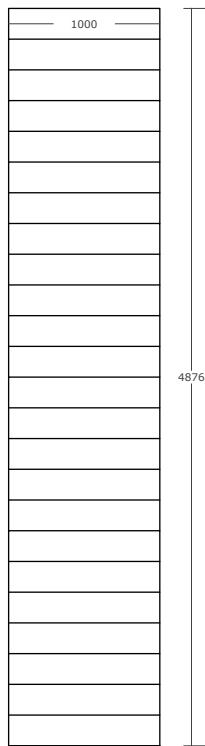

TL_Ramp Floor Boards

Platform Floor Boards
Timber 25x200mm - 1:50

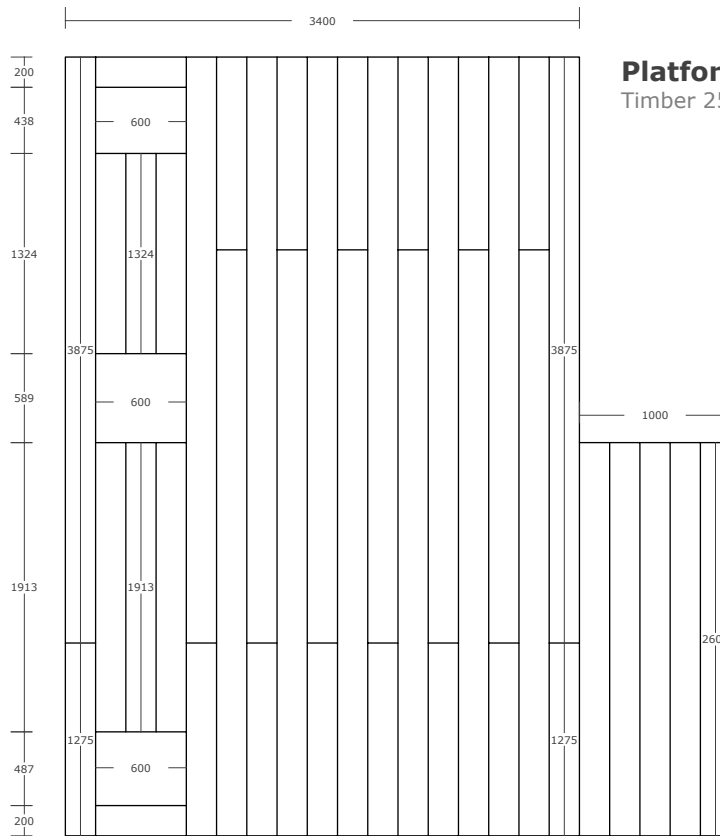

TL_Platform Floor Boards

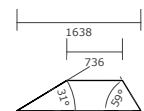

TL_P07

Trench Latrines Block

Details

Print to size A4

MARCH 2022

Cubicle Panels

Timber 50x100mm - 1:50

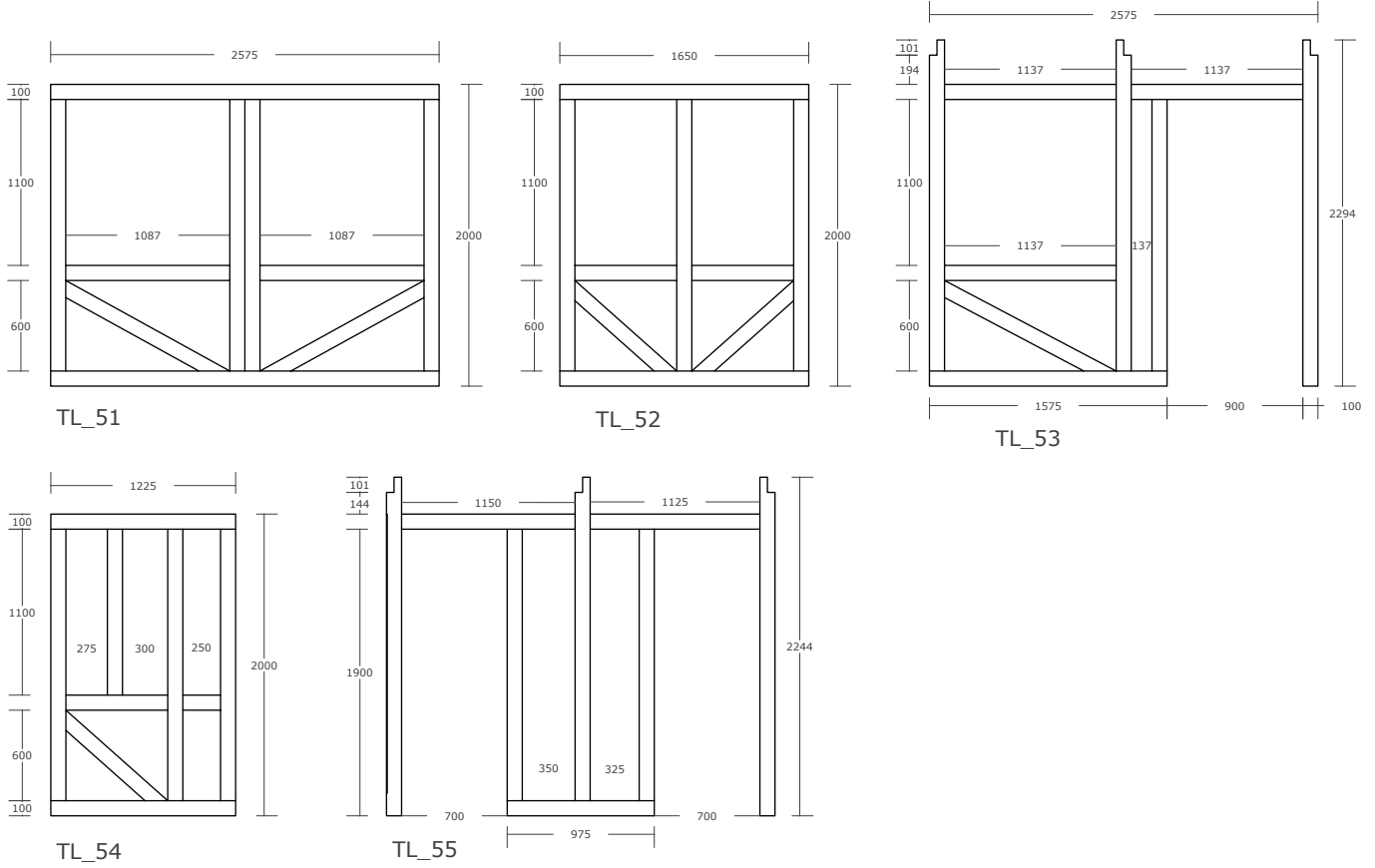

Trench Latrines Block

Details

Print to size A4

MARCH 2022

Platform Screen Panels

Timber 50x50mm - 1:50

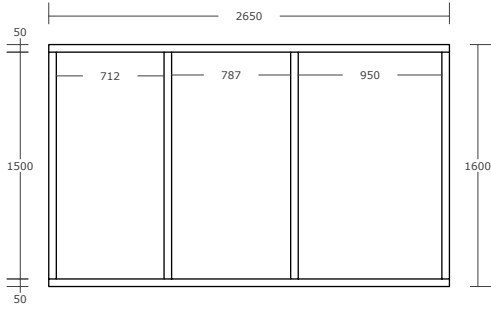

TL_61

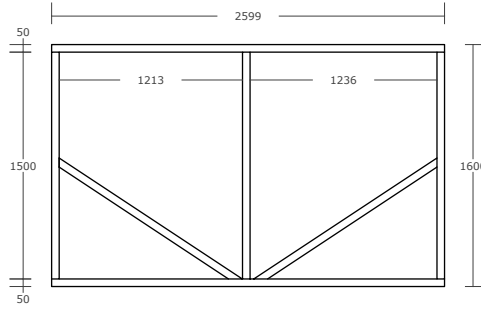

TL_62

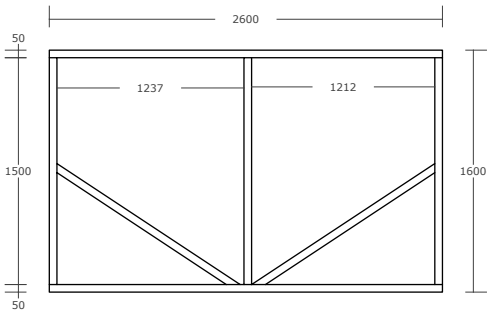

TL_63

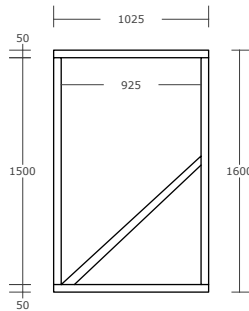

TL_64

Roof Panels

Timber 50x50mm - 1:50

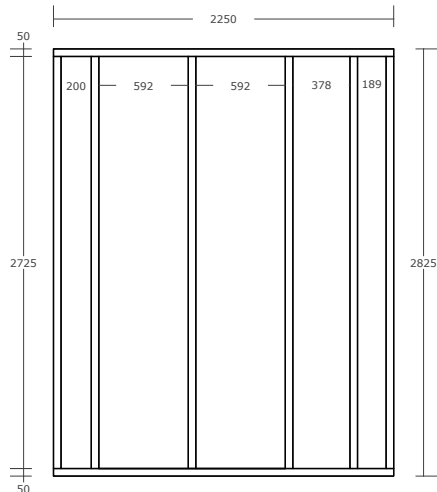

TL_71

Doors

Timber 50x50mm

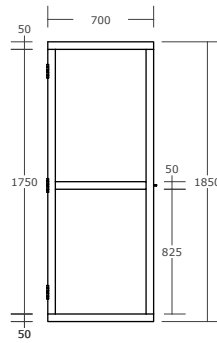

TL_72

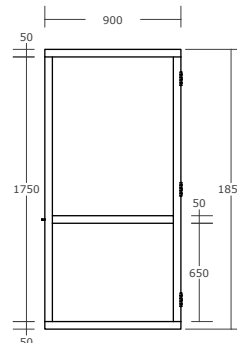

TL_73

Trench Latrines Block

Details

6.4 Trench Latrine Block Step-by-Step Construction Sequence

Step 1:
PLATFORM

- To accommodate the structure and a surround clearance of 1m for construction, a total area of **6.5m x 9m** to be cleared and perfectly levelled.

-Clear area of **7.5m x 9m** if timber propping required. Refer to *Appendix B.1 Component Details*.

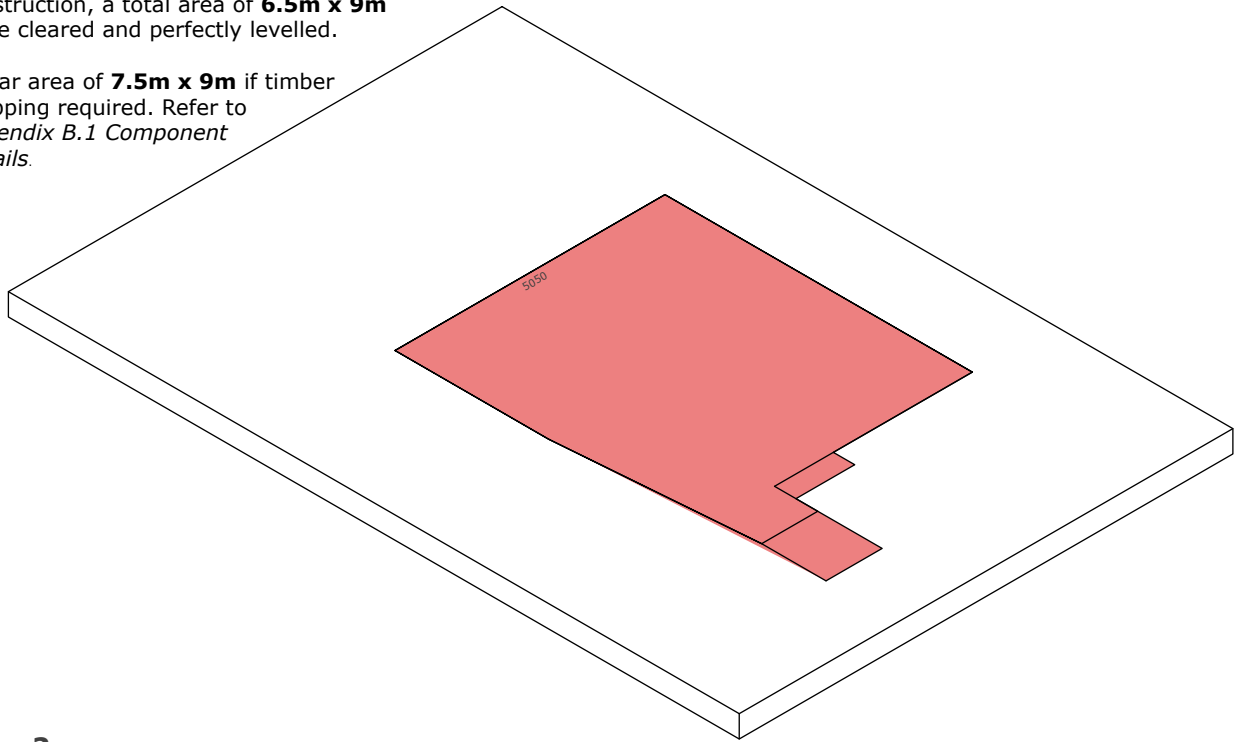
**Step 2:**
TRENCH

- Dig **2m deep** trench with dimensions of **0.9m wide** and **4.8m long**.

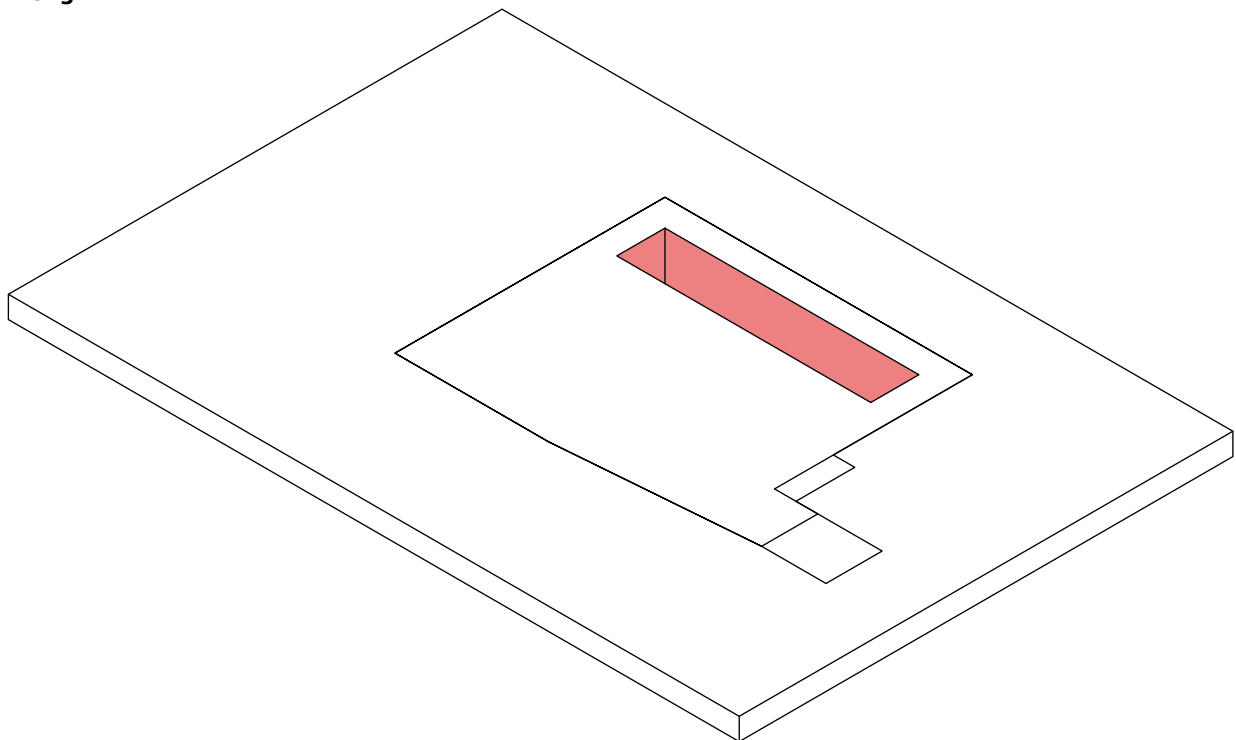
**Trench Latrines Block**

Step by step

Print to size A4

MARCH 2022

Step 3: TRENCH

- Install vertical timber planks (**TL_P01**) around the perimeter.

- Install 4x wooden planks (2x **TL_P02** and 2x **TL_P03**) on the inside to create a box.

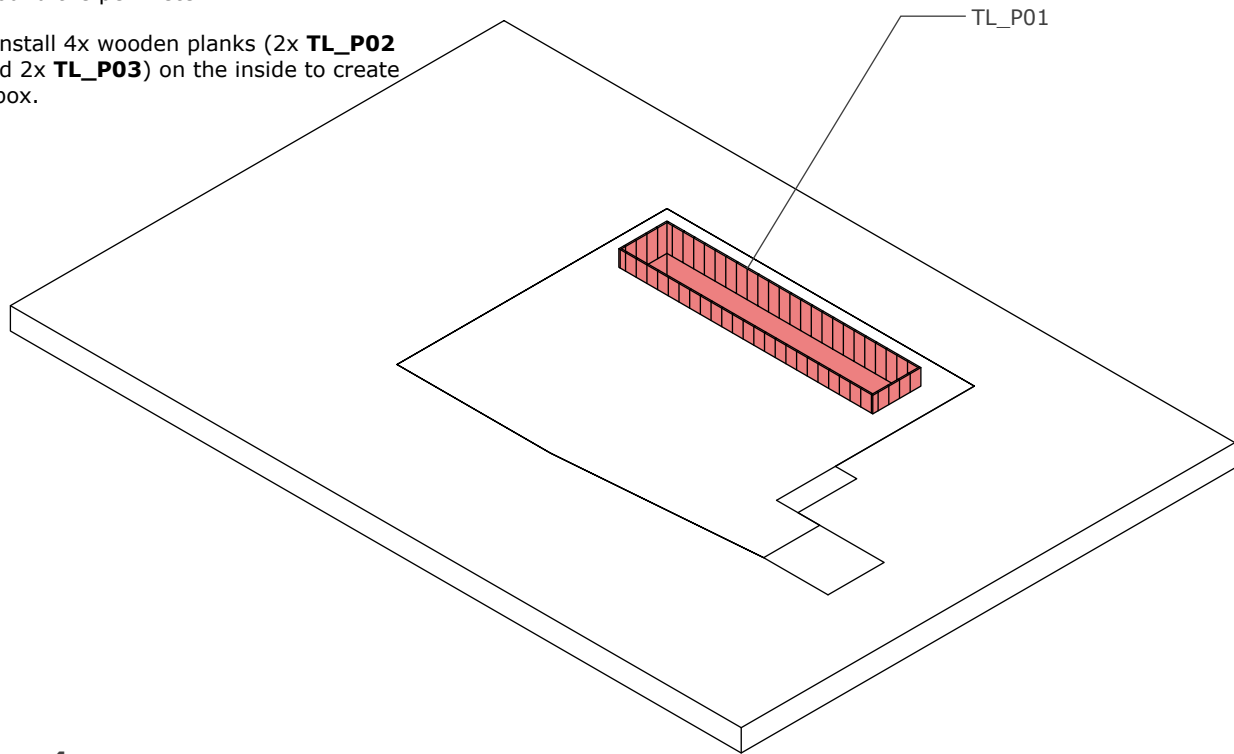

Step 4: PLATFORM

- Install a **0.3m build up** of soil for a **4.45m x 5.15m** compacted and level raised area. Angle of compacted soil around edge must not exceed 45 degrees. Allow for a minimum dimension of 0.2m level soil around the perimeter of the trench.

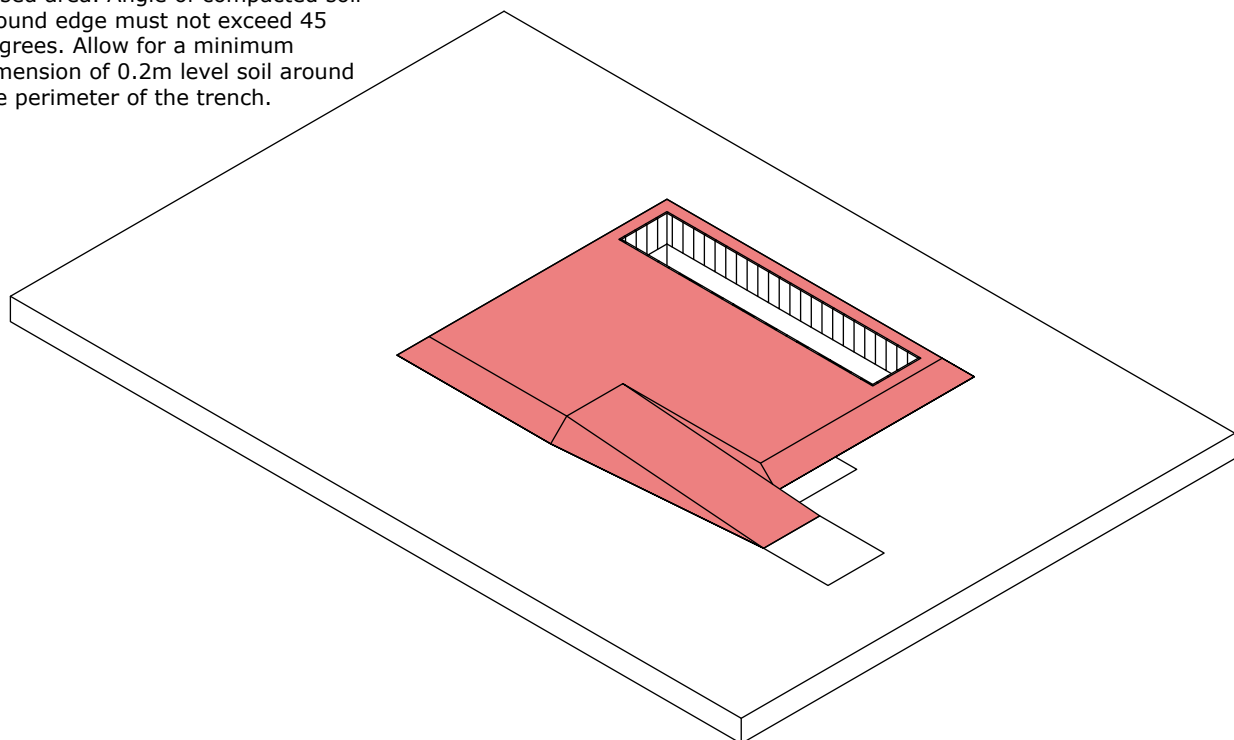

Trench Latrines Block

Step by step

Print to size A4

MARCH 2022

Step 5:
PLATFORM

- Install ground planks 4x **TL_P04** and 9x **TL_P05** over trench and screw in place.

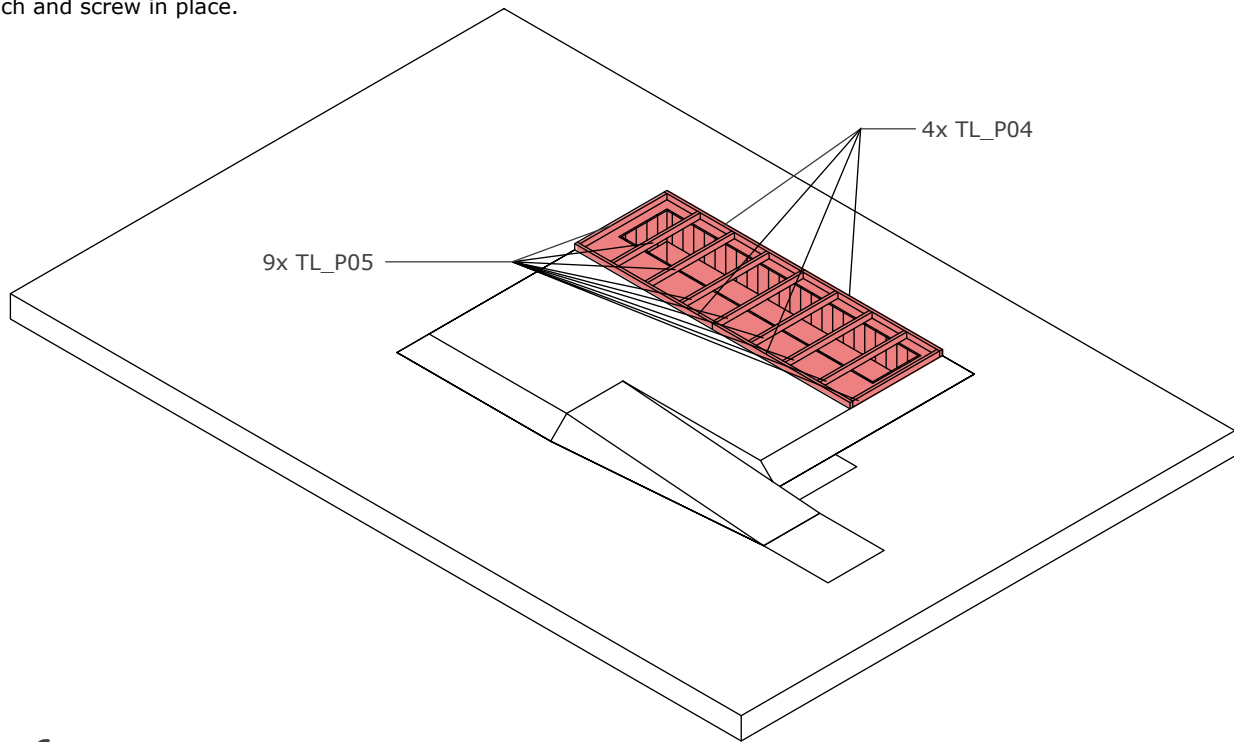
**Step 6:**
PLATFORM

- Install remainder of ground planks (9x **TL_P05**, 3x **TL_P04** and 5x **TL_P06**) with wooden screws.

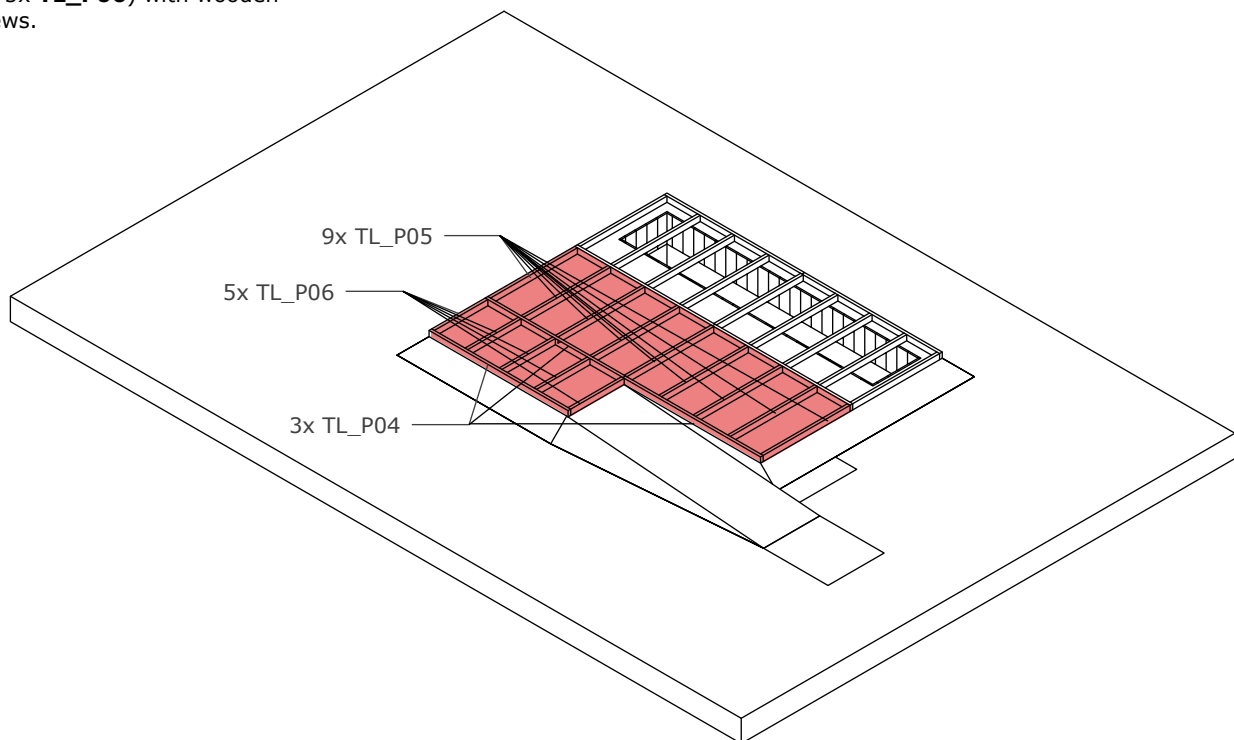
**Trench Latrines Block**

Step by step

Print to size A4

MARCH 2022

Step 7:**RAMP & STAIRS**

- Install panel **TL_41** for the ramp and bolt into place.
- Install 2x **TL_P07** for the side planks for the stairs with wooden screws.

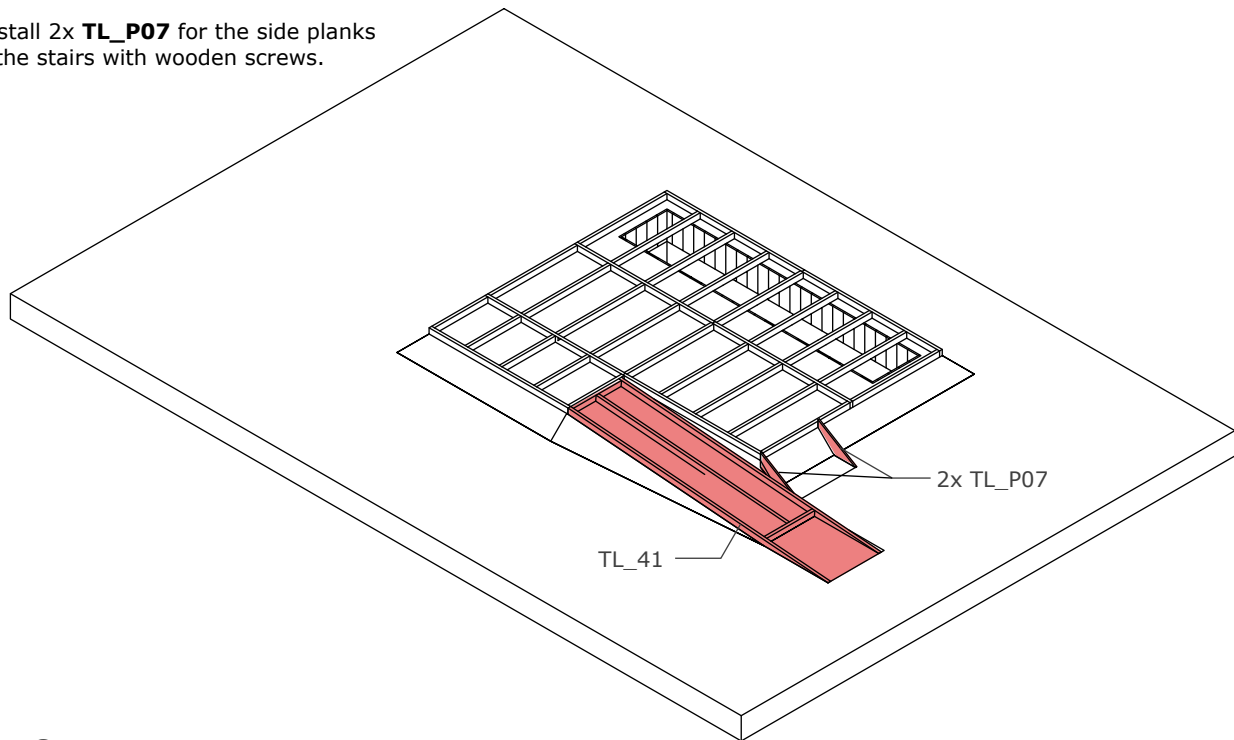
**Step 8:****TIMBER DECKING**

- Install **timber decking planks** across all of the ramp and the raised platform with nails leaving gaps for latrine holes.
- Install 2x **TL_P08** wooden planks for the stairs with wooden screws.

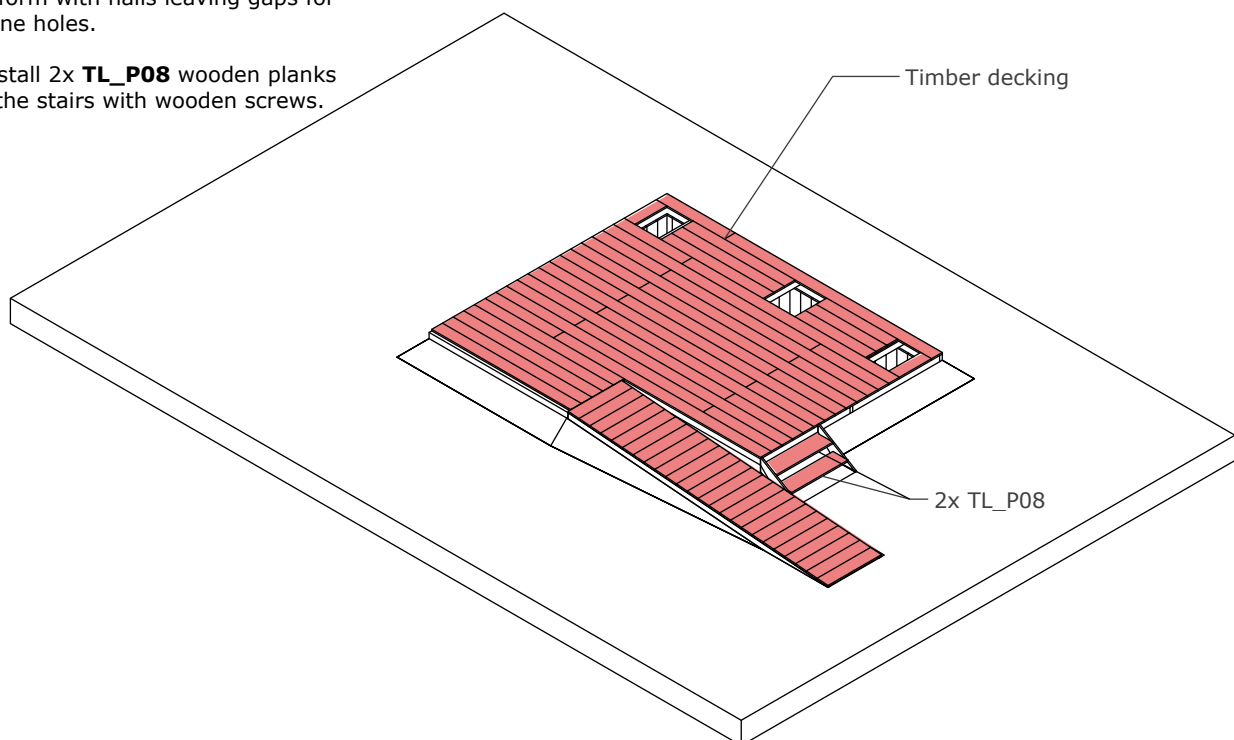
**Trench Latrines Block**

Step by step

Print to size A4

MARCH 2022

Step 9: LATRINE SLABS

- Place 3x **latrine slabs** in each location and bolt into place with fixing bolts provided.

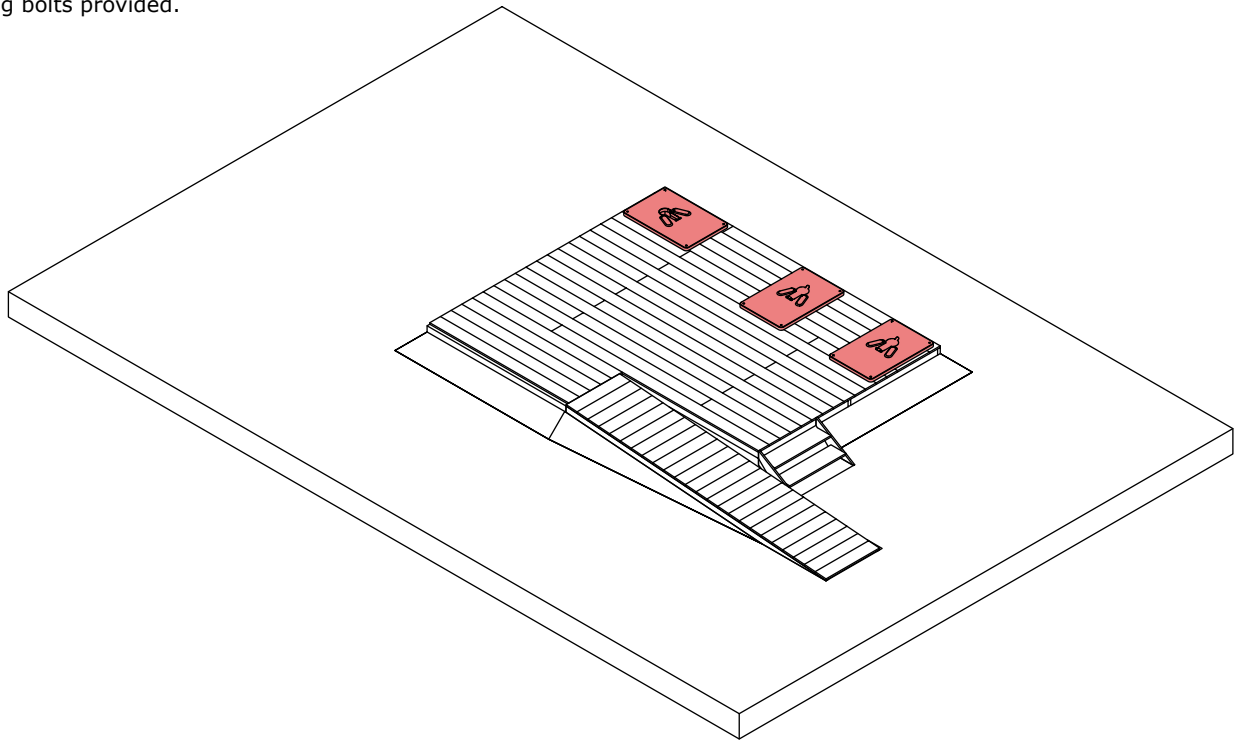

Step 10: CUBICLE PANELS

- Install **cubicle panels** (2x **TL_51**, 2x **TL_52**, 1x **TL_53**, 3x **TL_54**, and 1x **TL_55**) as reference tags indicate starting at the rear of the platform and working forwards. Bolt panels together.

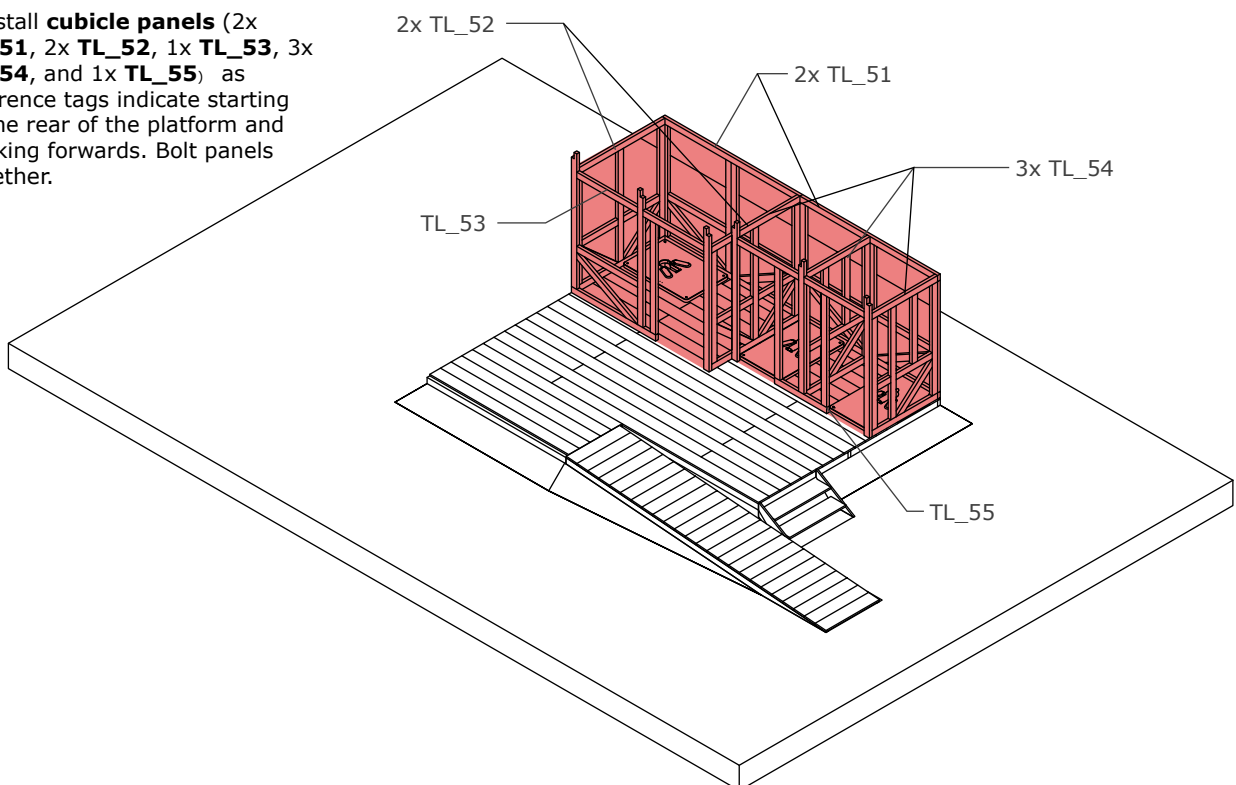

Trench Latrines Block

Step by step

Print to size A4

MARCH 2022

Step 11: CUBICLE PANELS

- Install planks 2x **TL_P09** to the back face of the Bathing Block and 1x **TL_P10** on the inside of the largest cubicle as shown. Fix with wood screws.

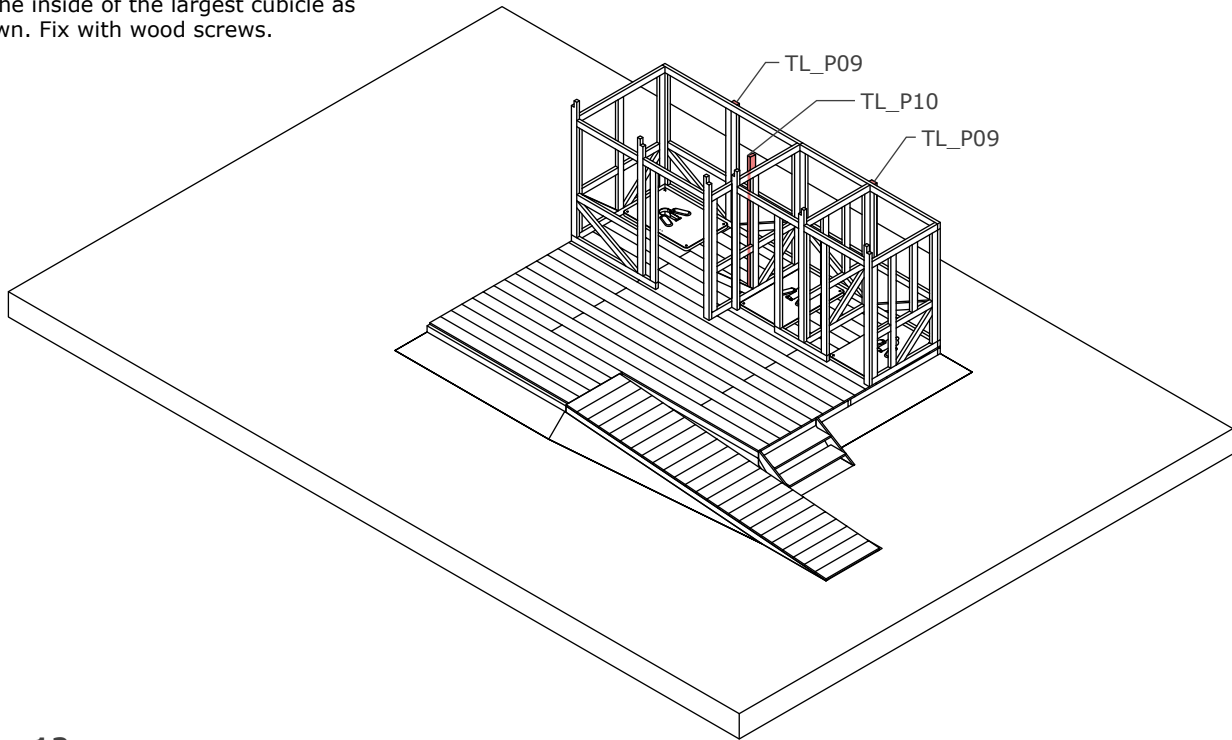

Step 12: SCREEN PANELS

- Install referenced **screen panels** (1x **TL_61**, 1x **TL_62**, 1x **TL_63** and 1x **TL_64**) around the perimeter of the raised platform as shown. Bolt panels together.

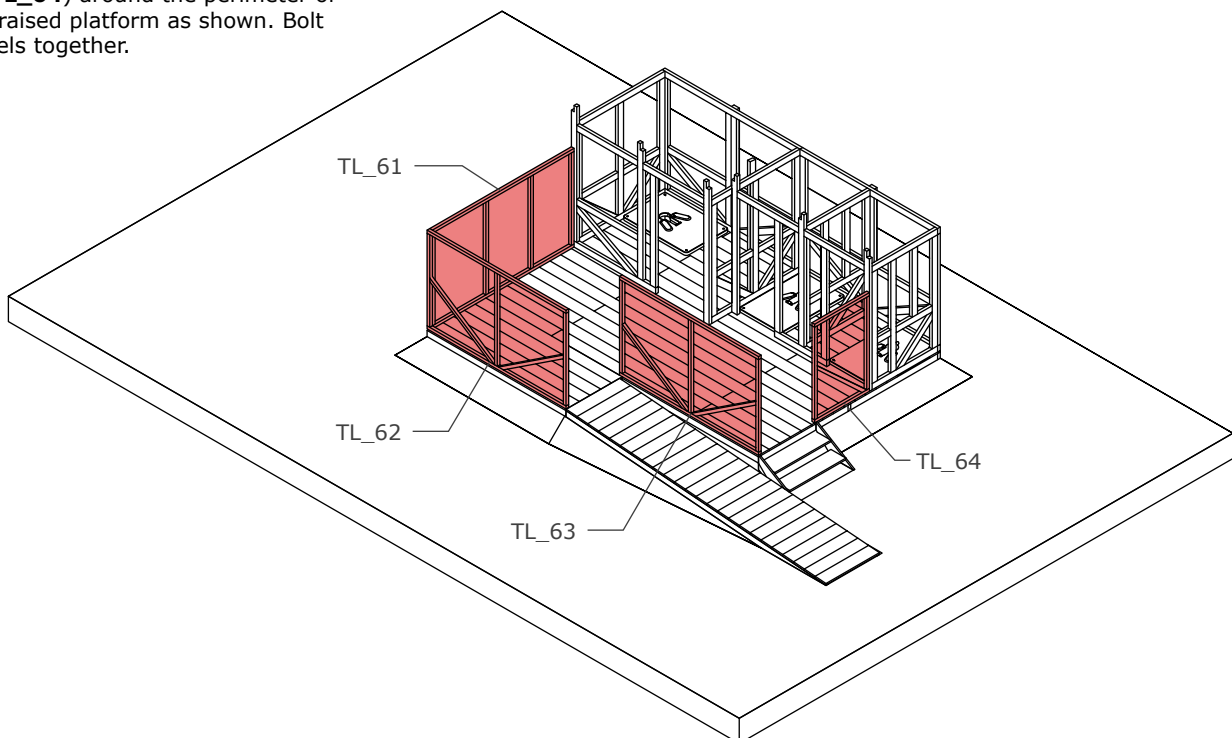

Trench Latrines Block

Step by step

Print to size A4

MARCH 2022

Step 13: RAILINGS

- Install 10x **TL_P11** vertical handrail posts as shown.

- Install handrail (**TL_P12**) around perimeter of the ramp and the stairs at 600 and 900mm heights from walking surface. Fix with wood screws.

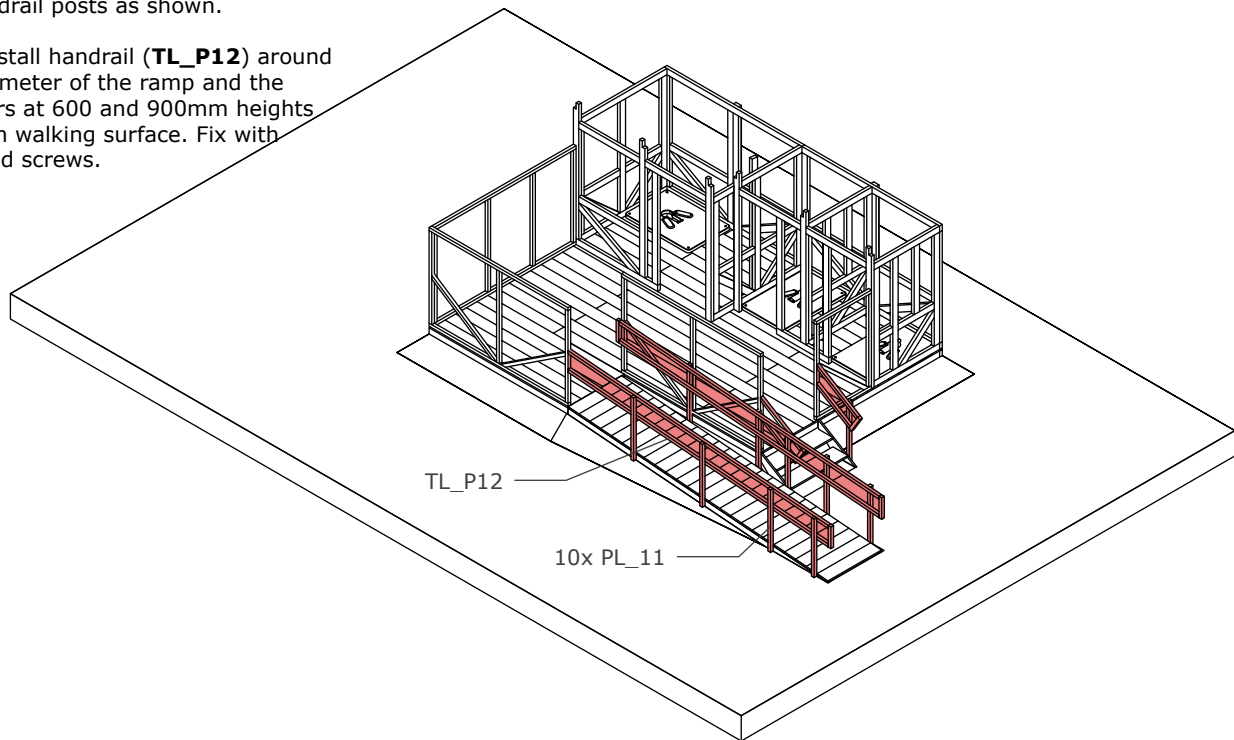

Step 14: ROOF

- Install 6x horizontal timber **TL_P13** roof supports on top of the cubicles and screw in place.

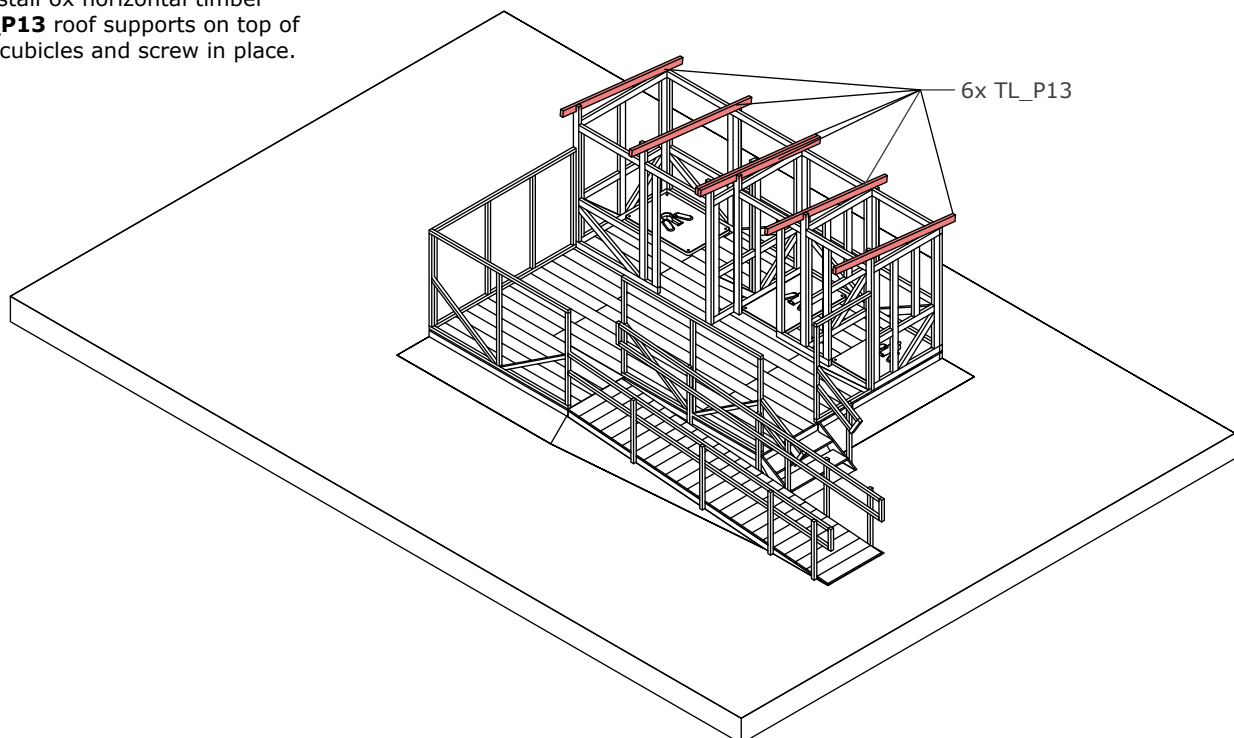

Trench Latrines Block

Step by step

Print to size A4

MARCH 2022

Step 15:
ROOF

- Install 2x **TL_71** roof panels to top of the cubicles bolting together.

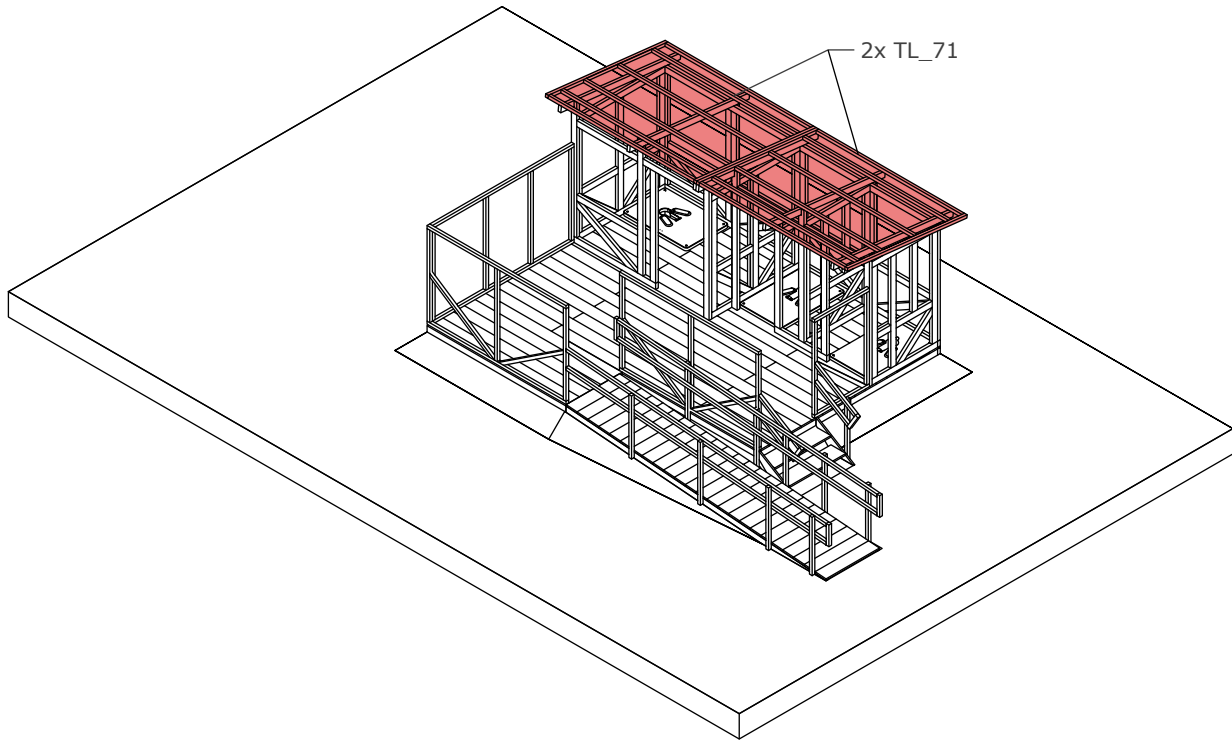
**Step 16:**
PLASTIC SHEETING

- Install cubicle doors x2 **TL_72** and 1x **TL_73**
- Install **plastic sheeting** with domed head nails around cubicles, screens and roof panels.
- Install equipment as detailed in cubicle plans.

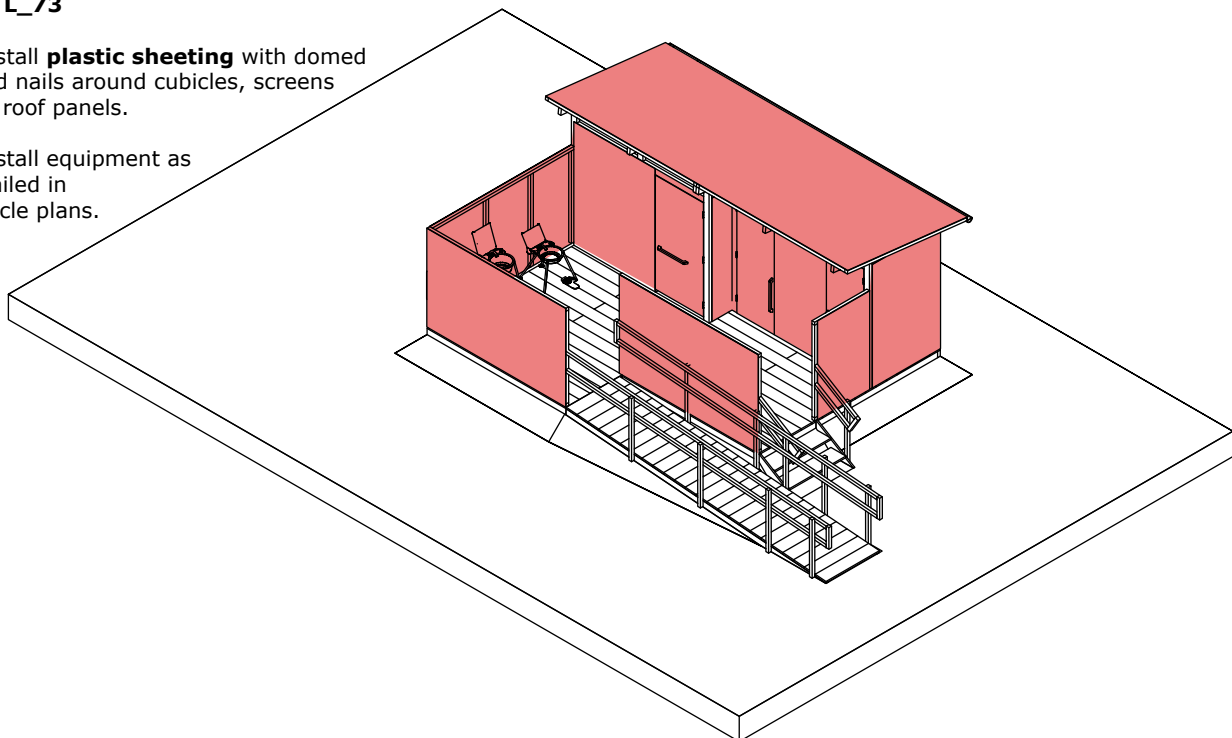
**Trench Latrines Block**

Step by step

Print to size A4

MARCH 2022

7 Template Design 2: Raised Latrine Block

This design is based on the UNHCR Emergency Raised Desludgable Holding Tank Latrine (D405-/2015 a).

It is a temporary MHM and disability-friendly toilet block, with a maximum design lifespan of 5 months. The design is appropriate for contexts where a trench latrine cannot be built, due to high groundwater table, rocky soil or other limiting conditions.

The toilet block is composed of two general cubicles and one accessible cubicle. Two handwashing units are available to the user and access to the raised platform is provided by ramp and stairs. The design incorporates all the elements highlighted in the previous section.

The faecal sludge is collected in tanks underneath the platform. The design allows the tanks to be desludged through a bottom flange, or through a lateral access in the top, to avoid desludging through the latrine hole.

Key points to note prior to procurement and construction:

- Use the guidance provided in Sections A & B of this manual to carry out assessments for context specific adaptation including:
 - User Consultation ([IFRC MHM Guide & Toolkit](#))
 - Site assessment (see [Site Checklist](#))
- Review the BOQ and substitute locally available materials and equipment where appropriate.
- Take note of the connection details and provide appropriate instruction to the construction team:
 - Timbers to be joined using four small wood screws per connection within a panel. Use four small wood screws per connection for each plank connection.
 - Panels to be bolted together for ease of storage, assembly, disassembly, moving and reuse in new locations.
 - Two bolt thread lengths have been specified in the BOQ (17cm and 22cm) to be used when connecting two timber pieces 5cm+10cm and 10cm+10cm respectively with a washer. In the step-by-step construction sequence, unless specified a 17cm bolt thread length should be used to connect panels together.

7.1 Raised Latrine Block Bill of Quantities

Ref	Item*	Quantity	Unit	Notes
1	Timber			
1.1	Wooden Posts (4m x 5cm x 5cm) Strength class C16, Density 4 to 6kN/m ³	55	pc	For screen's frame, doors' frame, handrails, ramp
1.2	Wooden Beams (4m x 10cm x 5cm) Strength class C16, Density 4 to 6kN/m ³	105	pc	For raised platform structure and cubicle framing
1.3	Wooden Planks (4m x 20cm x 2.5cm) Strength class C16, Density 4 to 6kN/m ³	60	pc	For floor, ramp, stairs and shelves
2	Fixings & Hardware			
2.1	Small wood screws (6mm x 150mm or equivalent No. 12 5.59mm diameter)	10.5	kg	4 wood screws at each connection location within a panel. 880 screws total
2.2	Nails (14cm Galvanized)	5	kg	To secure walking planks 2 per connection - 150 nails total
2.3	Domed Head Nails (4cm Galvanized)	4	kg	To fix plastic sheeting – every 30 cm or less 1112 nails total
2.4	Metal Bolts and Washers (M10 x 17cm)	64	pc	To join cubicle panels
2.5	Metal Bolts and Washers (M10 x 22cm)	24	pc	To join platform panels
2.6	Metallic self-closing Door Hinge (4cm x 8cm x 2mm Galvanized)	9	pc	3 per door. If they are not available use normal hinges and self-closing springs
3	Cladding			
3.1	Plastic Sheetting /Tarpaulin To meet the international minimum humanitarian standards (200g/m ² 700N tensile strength, UV stabilised laminated woven or braided mesh of black high density polyethylene between two white layers of low density polyethylene)	91	m ²	For walls, doors, and roof.
3.2	Mosquito net	4	m ²	For ventilation gaps in cubicles
4	WASH Components			
4.1	Self-Supporting Plastic Latrine Slab 1200x 800mm – Evenplate product	3	pc	For general and accessible toilets.
4.2	Toilet seat - ICONO	1	pc	For accessible cubicle
4.3	150 mm diameter pipe	4.5	m	For the disposal system
4.4	60 L tank	1	pc	Water storage for handwashing
4.5	1000 L tank - max height 1100 mm, max diameter 1200mm	2	pc	For faecal sludge from general cubicles
4.6	500 L tank - max height 1250 mm, max diameter 1200mm	1	pc	For faecal sludge from accessible cubicles
4.7	Butyl Tank collar	3	pc	To connect tank to latrine slab.
4.8	Jengu Handwashing Unit	2	pc	To be deployed or replicated locally
4.9	Jengu Handwashing Unit Accessible	1	pc	To be deployed or replicated locally

Ref	Item*	Quantity	Unit	Notes
5	Fixtures & Fittings			
5.1	Door locks – door bolt type 4cm long	3	pc	For doors in the 3 cubicles
5.2	Wooden Grab Rails and Door Handles (Minimum 500mm Length)	9	pc	For the door both sides and one inside each cubicle
6	Accessories			
6.1	20 Litre Bucket with lid and ladle	3	pc	One in each cubicle to provide water inside
6.2	Hanging bell	3	pc	One in each cubicle
6.3	Hooks	6	pc	Two in each cubicle
6.4	Padlock	3	pc	To lock the bins of the disposal system
6.5	300x 800 mm mirror	3	pc	One in each cubicle
6.6	150 mm diameter lid (for top of 150mm pipe)	3	pc	For the disposal system
6.7	20 L Bin with lid	3	pc	For disposal system under the platform

ANCHORING OF LATRINE BLOCK FOR WINDSPEEDS >25M/S

Requirement for the following depends on site conditions:

Ref	Item	Quantity	Unit	Notes
A 1	Option 1: Timber propping			
A 1.1	Wooden studs (4m x 10cm x 5cm) Strength class C16, Density 4 to 6kN/m ³	10	pc	Timber propping
A 1.2	Small wood screws (6mmx 150mm or equivalent No. 12 5.59mm diameter)	200	pc	
A 1.3	100kg sandbag	10	pc	
A2	Option 2: Sandbags only			
A 2.1	100kg sandbag	15	pc	

Key Notes on the BOQ:

All items may be substituted with alternatives (ready-made or locally fabricated) provided they are of equivalent performance and size. The field team is responsible for checking details of dimensions and connections for compatibility with the facility as designed, making any adaptations required to accommodate the substitution.

The **strength class of the timber planks** for this design is C16 (C for coniferous) referred to in Eurocode 5 and graded in accordance with BS EN 14081. Please refer to Section 9.3.1 for further information on the structural specification of the timber required for the latrine block.

Additional items requiring local / site specific selection

The field-team should consider site specific conditions that might require additional elements to be specified and procured. Blank rows are included at the end of the BOQ to allow for these additions. This may include for example:

- **LIGHTING:** The lighting solution has not been included as it should be specific to each site, and developed in consultation with the user groups. The field team will need to consider what

7.2 Raised Latrine Block Architectural Drawings and Visualisations

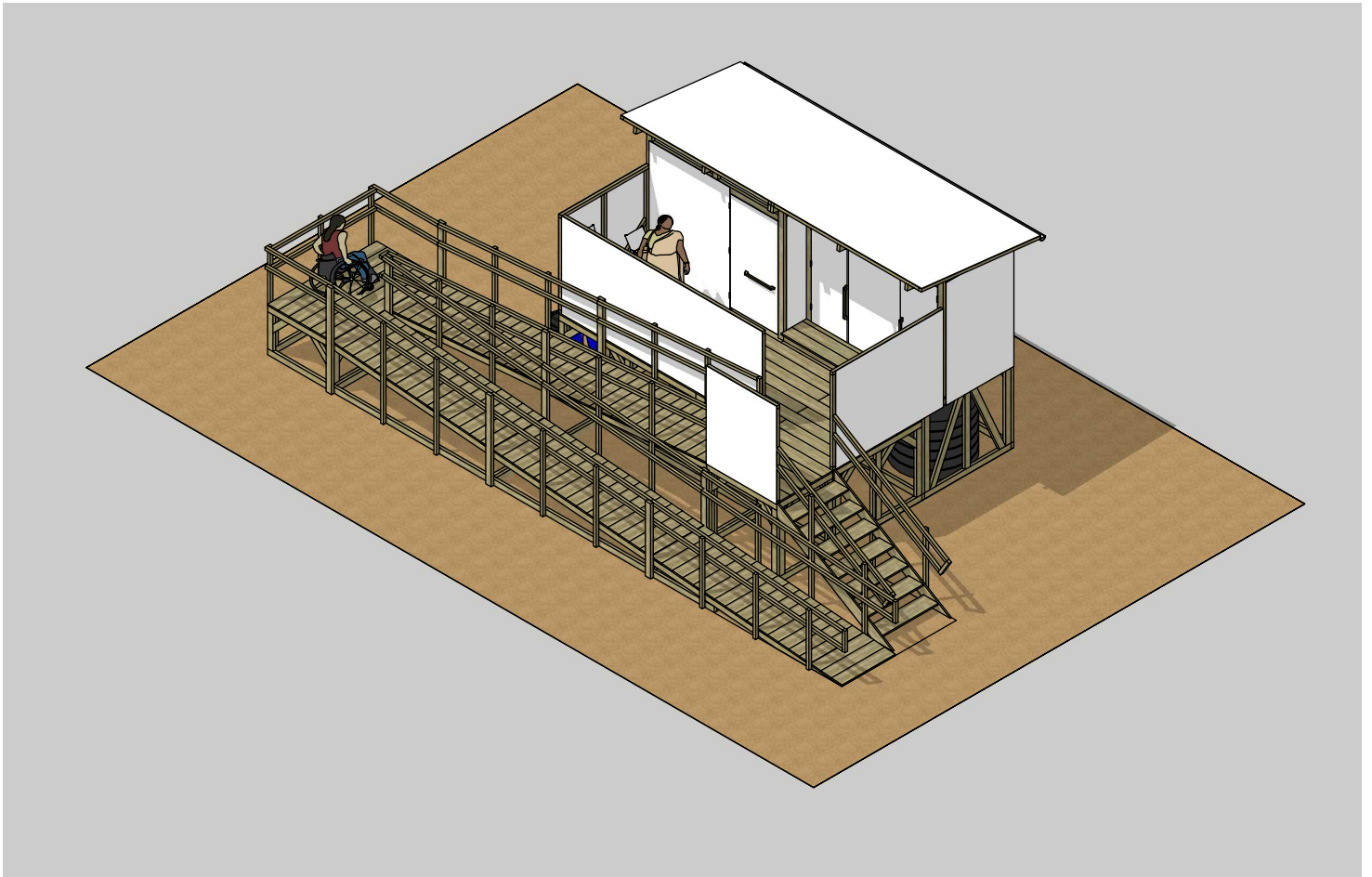

Raised Latrines Block
Isometric view

Latrine Cubicle
Plan 1:50

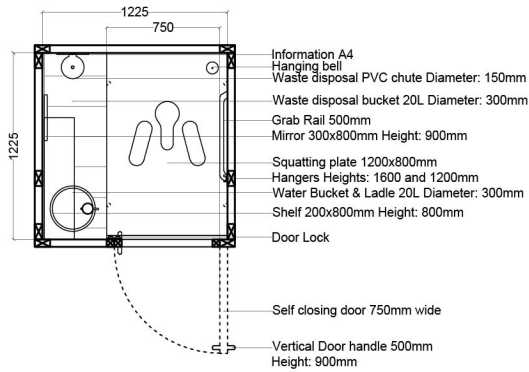

Latrine Cubicle PRM
Plan 1:50

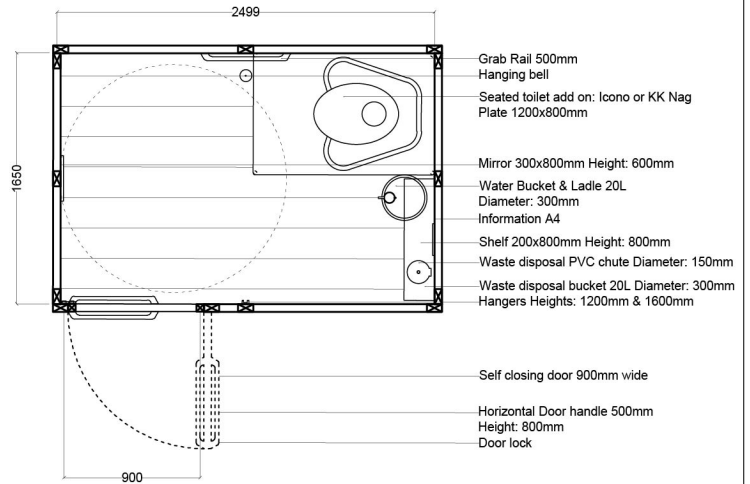

Latrine Cubicle
Section 1:50

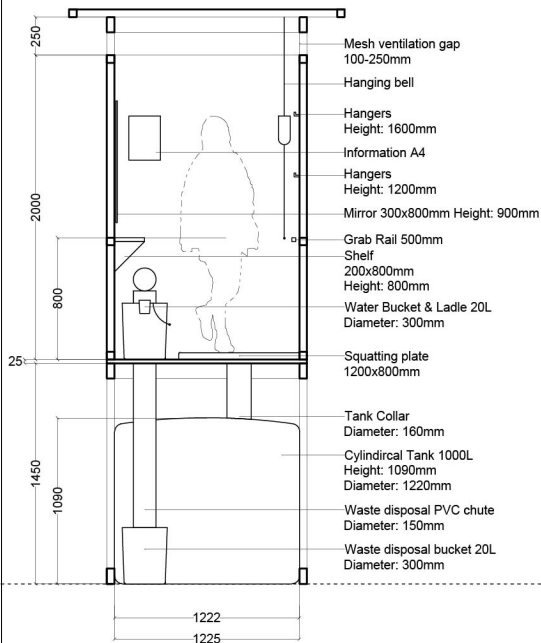

Latrine Cubicle PRM
Section 1:50

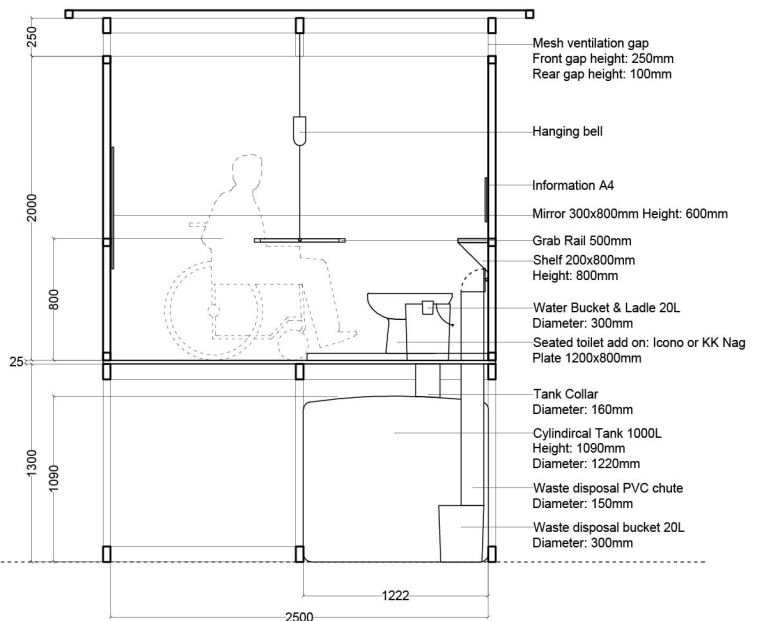

Raised Latrines Cubicles
Plan & Section

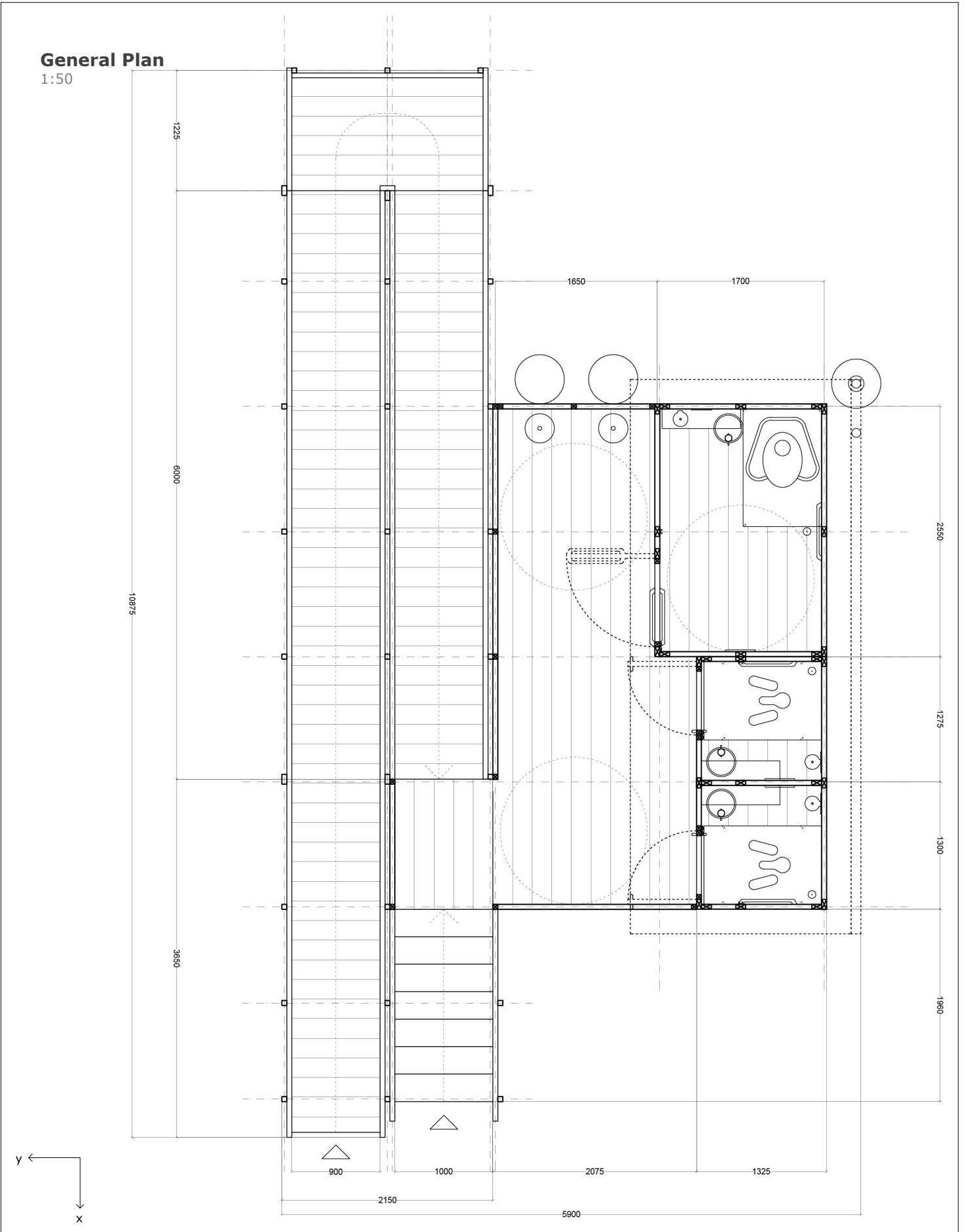

Raised Latrines Block
Plans

Support Structure Plan 1:50

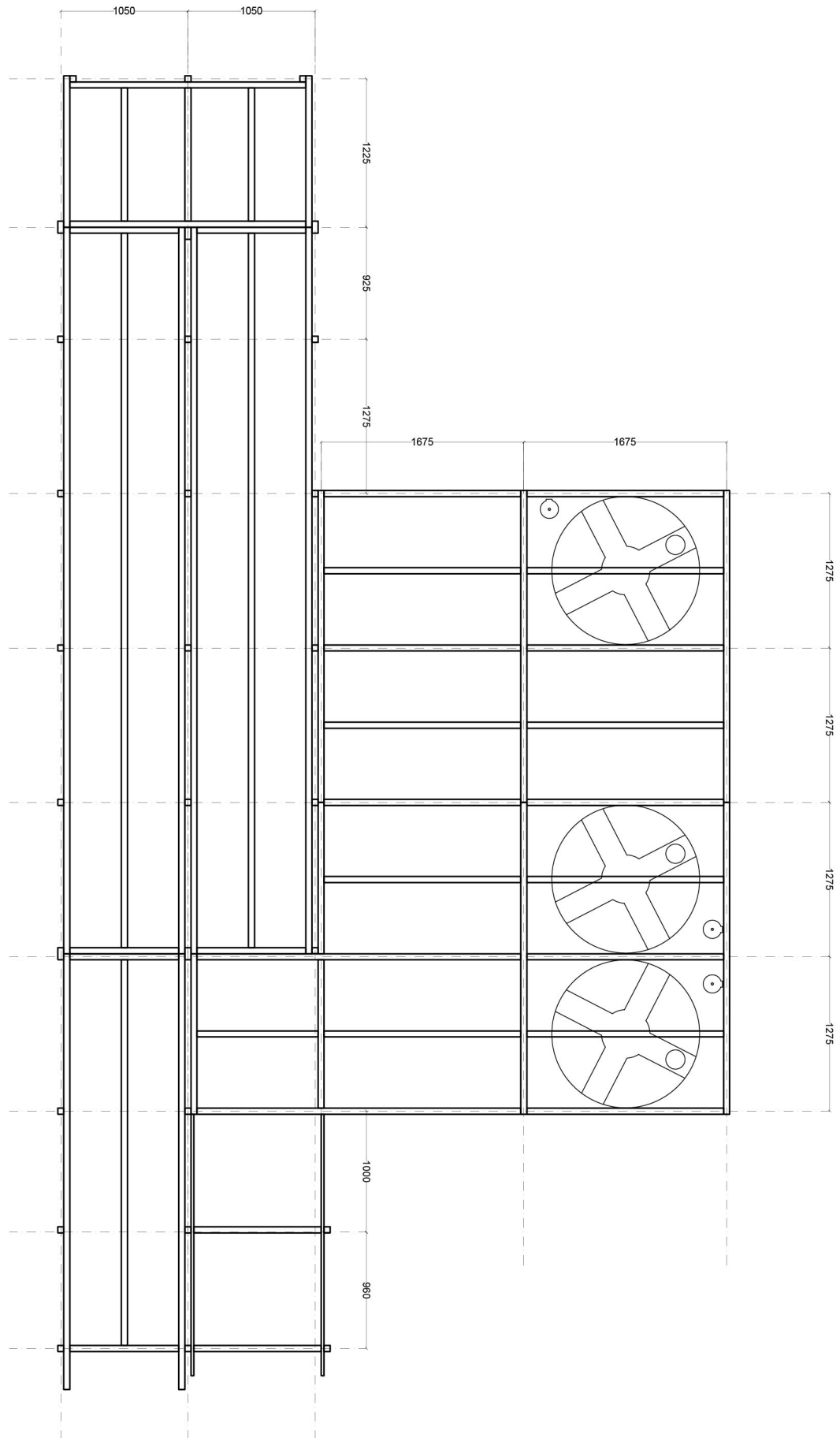

Raised Latrines Block Plans

Print to size A4

MARCH 2022

Front View

1:75

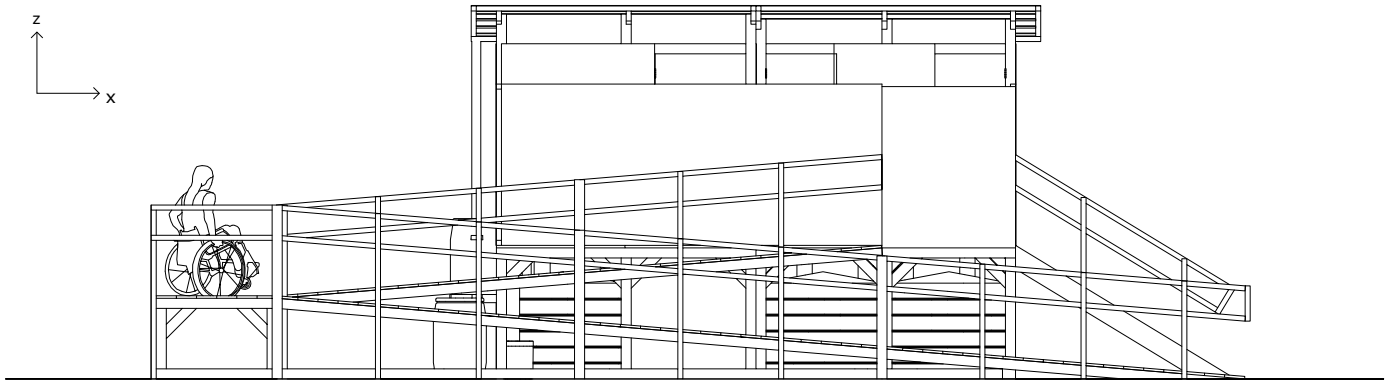
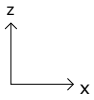

Rear View

1:75

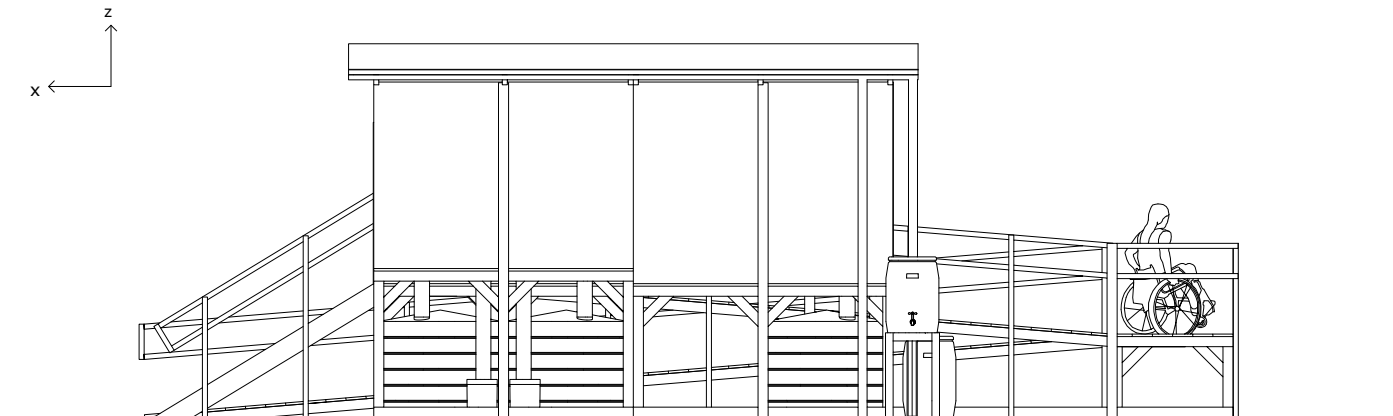
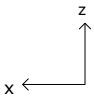

Side View

1:75

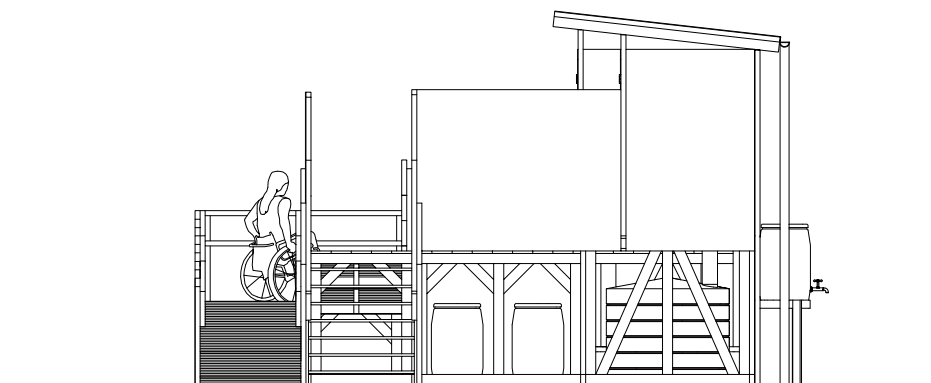
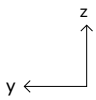

Raised Latrines Block

Elevation Views

Print to size A4

MARCH 2022

Longitudinal Section View

1:75

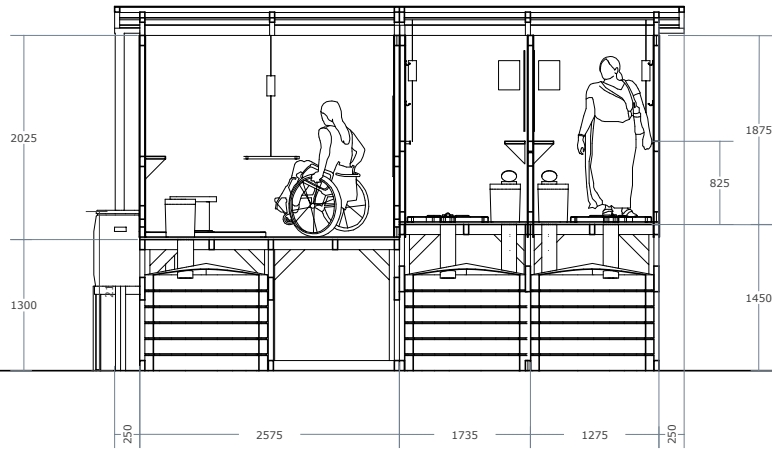
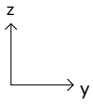

Cross Section View

1:75

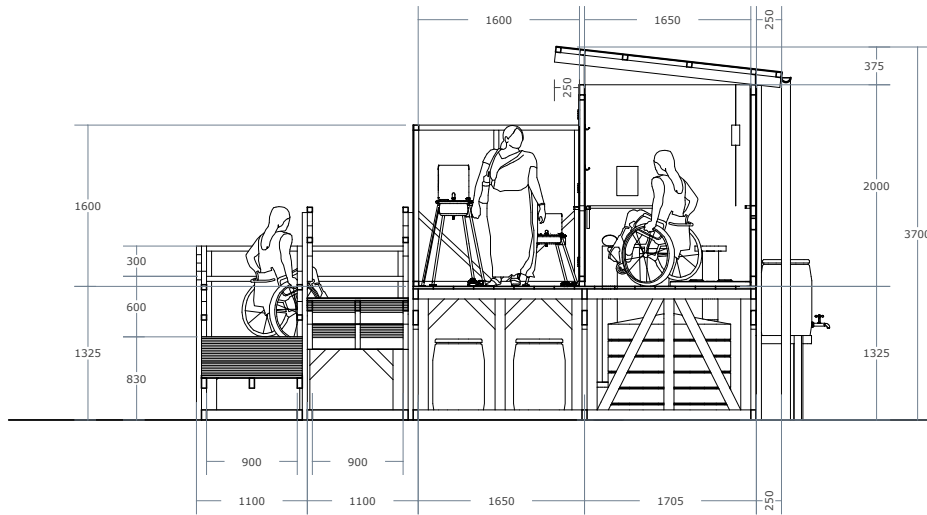
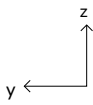

Ramp & Stairs Elevation

1:75

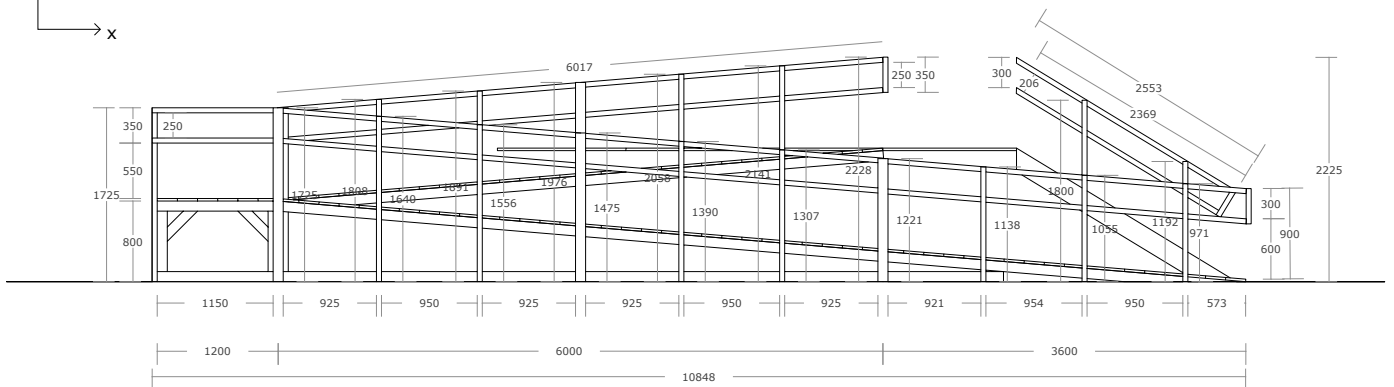
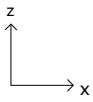

Raised Latrines Block

Section Views

Isometric Front View

1:100

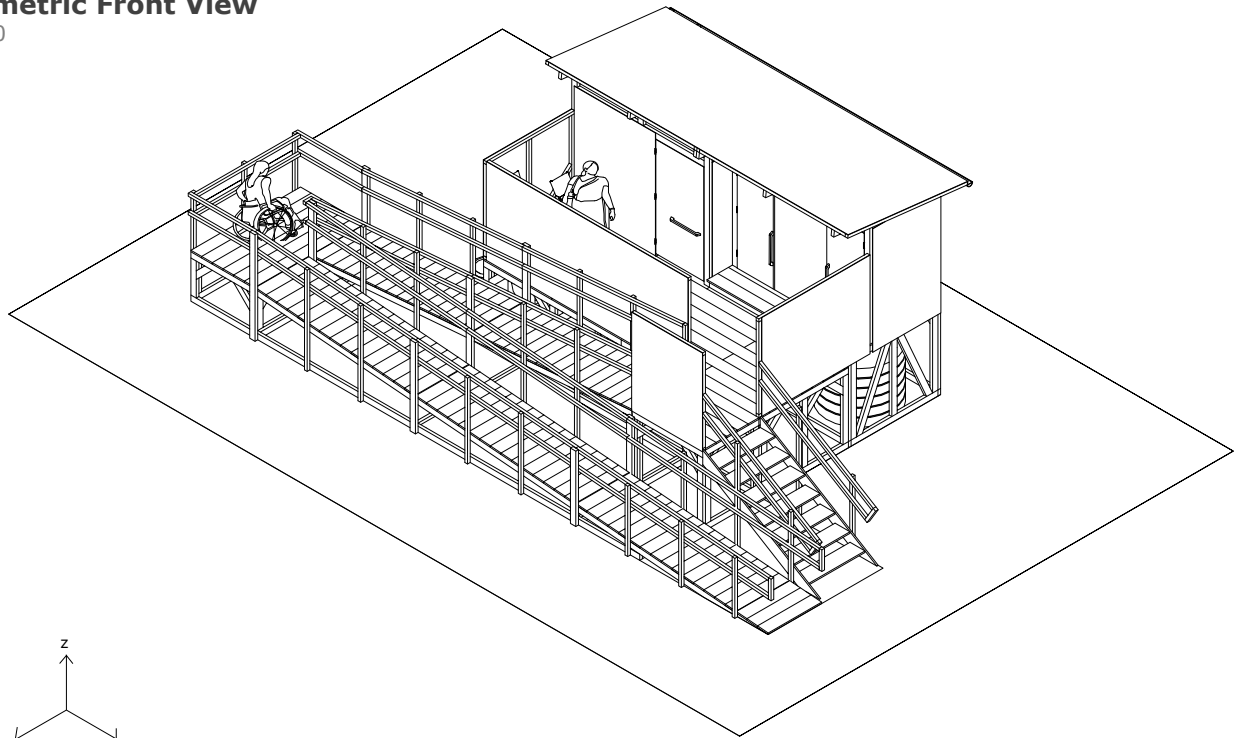

Raised Latrines Block

Isometric views

Print to size A4

MARCH 2022

Isometric Below View

1:100

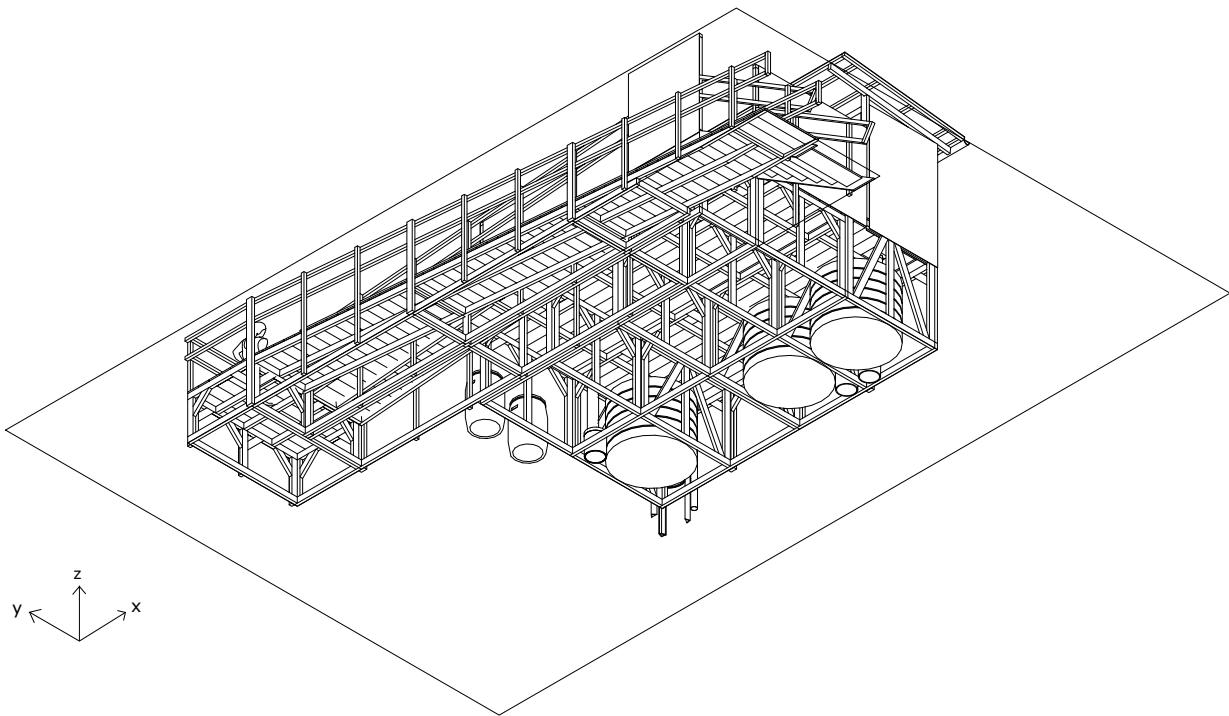

Raised Latrines Block

Isometric views

Print to size A4

MARCH 2022

7.3 Raised Latrine Block Panel Lists & Diagrams

Panel List

Raised Latrine - RL

Panel reference code	Number required
RL 01	3
RL 02	3
RL 03	5
RL 04	2
RL 11	5
RL 12	2
RL 13	1
RL 21	1
RL 22	4
RL 31	2
RL 32	2
RL 41	4
RL 42	1

Panel reference code	Number required
RL 51	1
RL 52	2
RL 53	1
RL 54	3
RL 55	1
RL 56	1
RL 61	1
RL 62	1
RL 63	1
RL 64	1
RL 71	2
RL 72	2
RL 73	1

Plank List

Raised Latrine - RL

Plank reference code	Section	Length (mm)	Number required	Reference
RL P01	50x100	1625	6	Platform
RL P02	50x100	1575	2	Platform
RL P03	50x100	1200	1	Platform
RL P04	50x100	1225	1	Platform
RL P05	50x100	1000	1	Platform
RL P06	50x100	1100	3	Ramp
RL P07	50x100	Ramp height + 925mm	8	Ramp
RL P08	25x200	2560	2	Stair
RL P09	50x50	Ramp height + 925mm	30	Ramp
RL P10	25x200	1050	6	Stair
RL P11	50x50	Refer to ramp elevation		Handrail
RL P12	50x100	90	2	Cubicle frame
RL P13	50x100	3315	2	Cubicle frame
RL P14	50x100	2250	6	Roof support

If timber propping is needed:

Plank reference code	Section	Length (mm)	Number required	Reference
RL P15	50x100	1000	10	Timber propping
RL P16	50x100	1300	10	Timber propping
RL P17	50x100	1650	10	Timber propping

Raised Latrines Block

Lists of panels and planks

Print to size A4

MARCH 2022

Platform Frames

Timber 50x100mm - 1:50

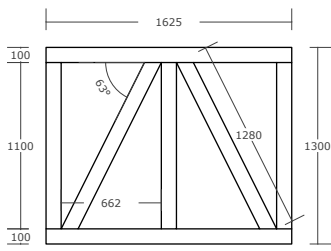

RL_01

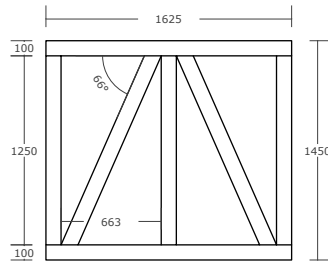

RL_02

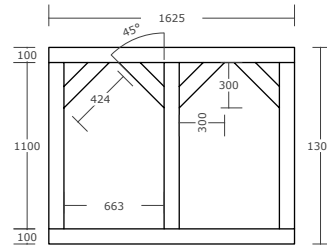

RL_03

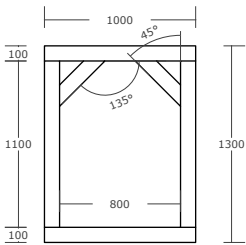

RL_04

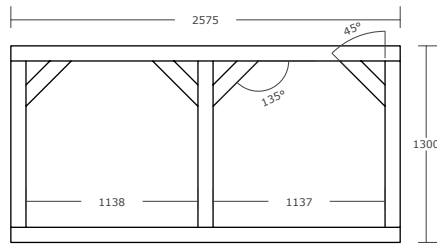

RL_11

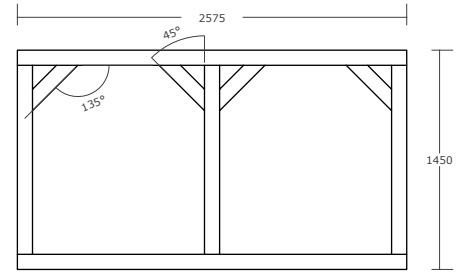

RL_12

Platform Floor Boards

Timber 25x200mm - 1:50

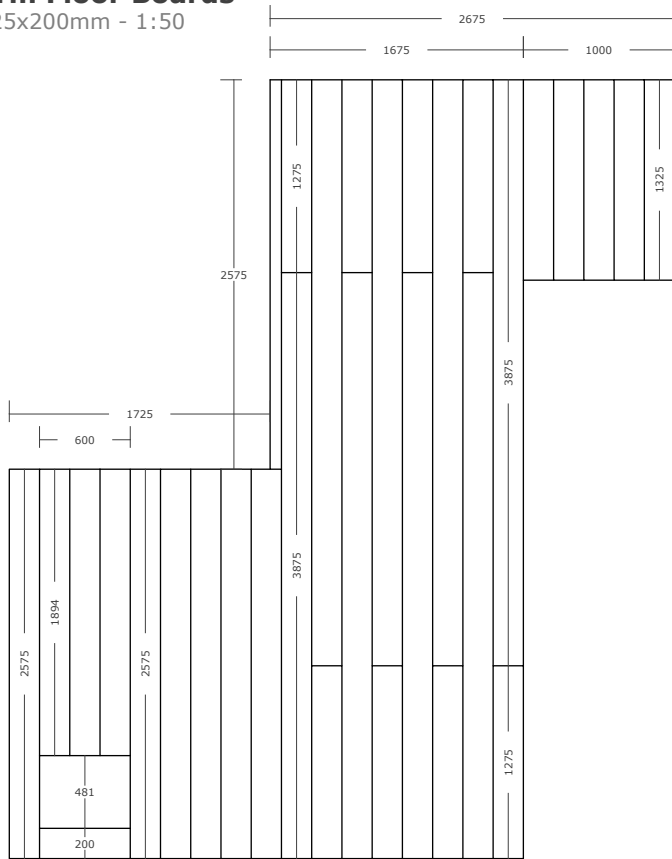

RL_Platform Floor Boards 01

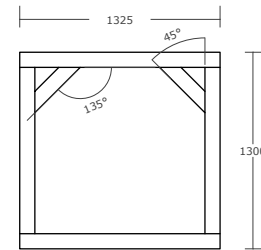

RL_13

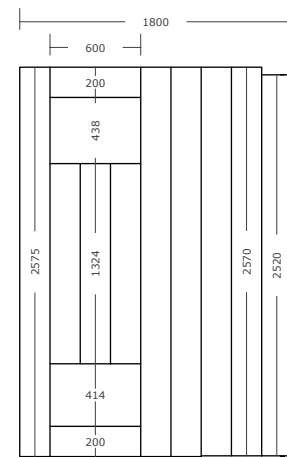

RL_Platform Floor Boards 02

Raised Latrines Block

Details

Print to size A4

MARCH 2022

Ramp Frames

Timber 50x100mm - 1:50

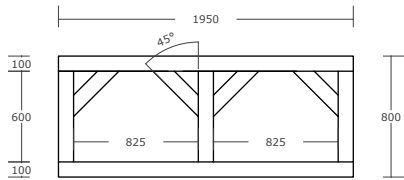

RL_31

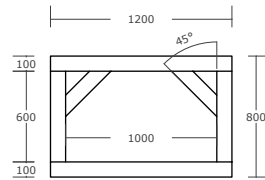

RL_32

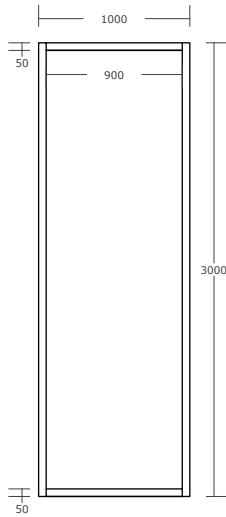

RL_21

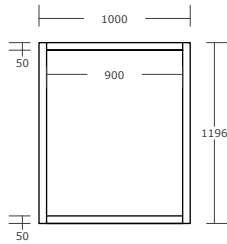

RL_22

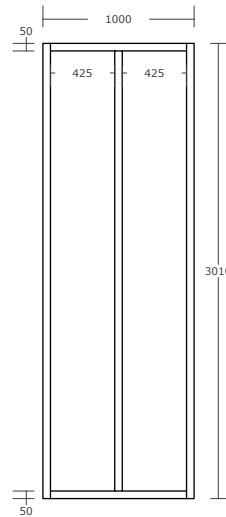

RL_41



RL_42

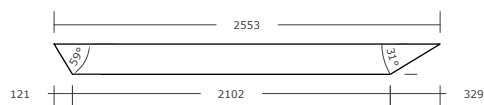

RL_P08

Ramp Floor Boards

Timber 25x200mm - 1:50

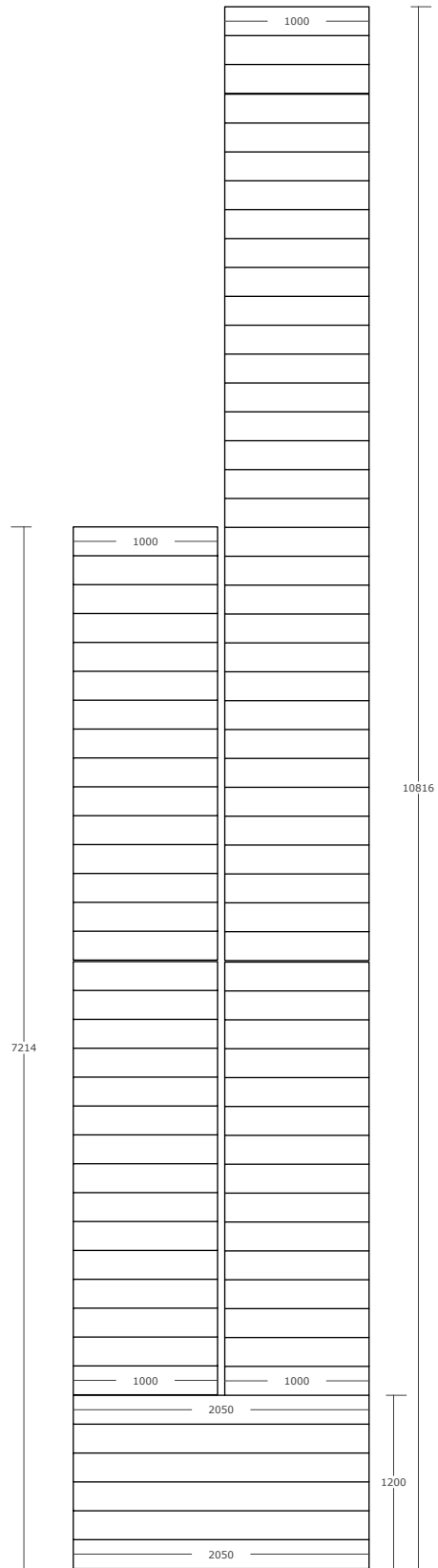

RL_Ramp Floor Boards

Raised Latrines Block

Details

Print to size A4

MARCH 2022

Cubicle Panels

Timber 50x100mm - 1:50

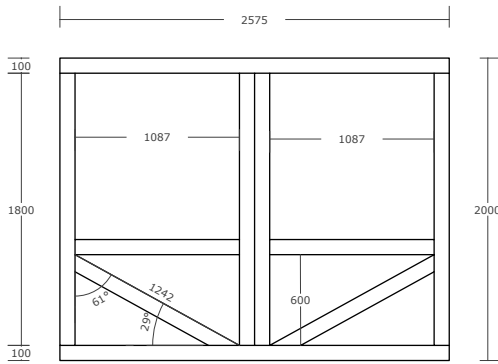

RL_51

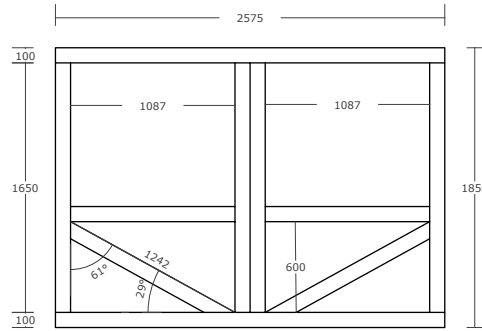

RL_56

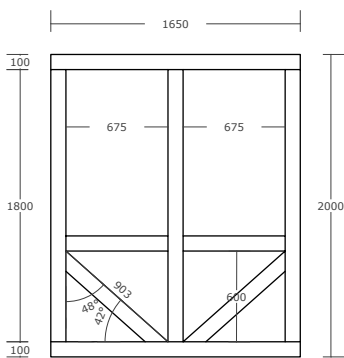

RL_52

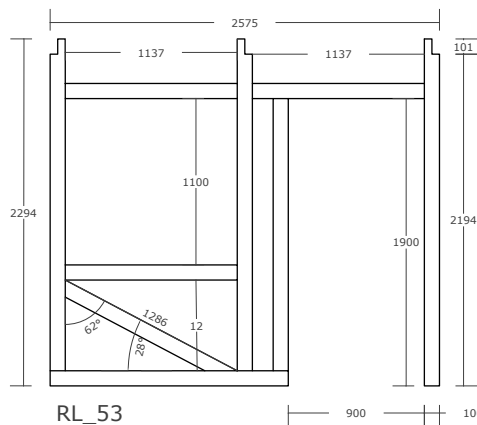

RL_53

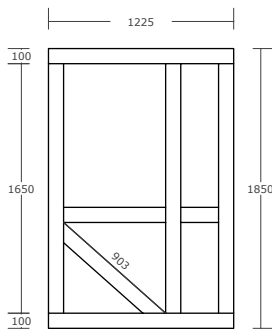

RL_54

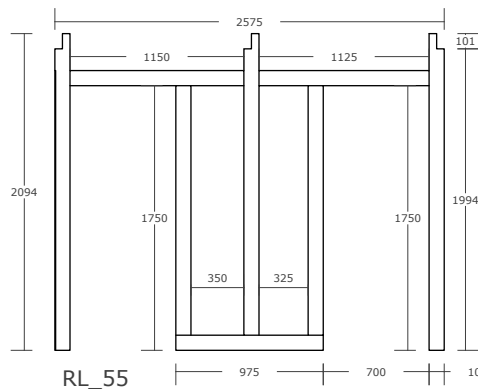

RL_55

Raised Latrines Block

Details

Print to size A4

MARCH 2022

Platform Screen Panels

Timber 50x50mm - 1:50

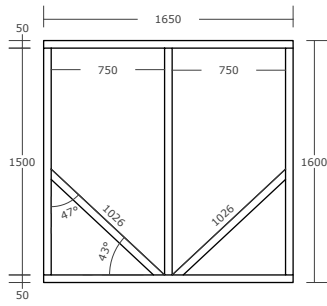

RL_61

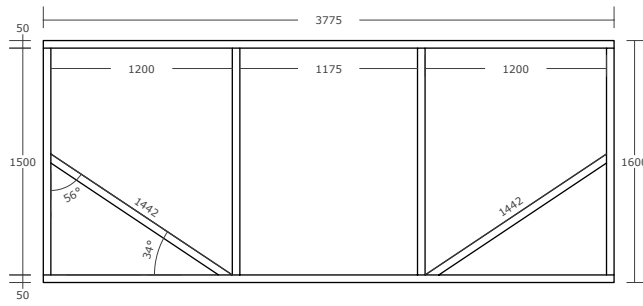

RL_62

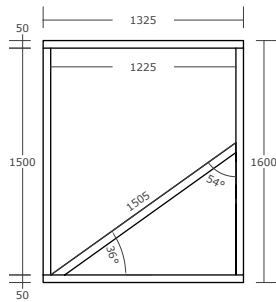

RL_63

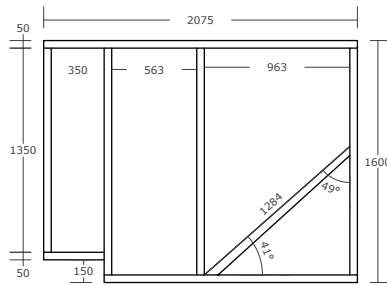

RL_64

Roof Panels

Timber 50x50mm

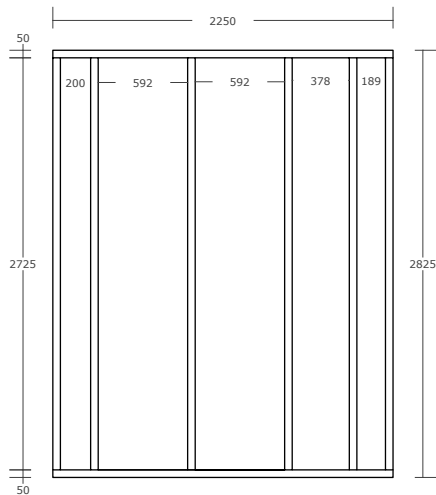

RL_71

Doors

Timber 50x50mm

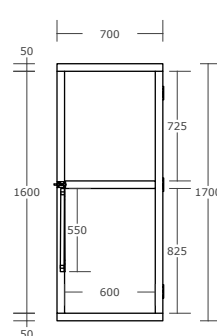

RL_72

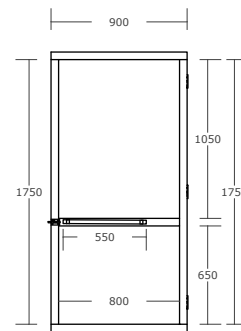

RL_73

Raised Latrines Block

Details

Print to size A4

MARCH 2022

7.4 Raised Latrine Block Step-by-Step Construction Sequence

Step 1:
PLATFORM

- To accommodate the structure and a surround clearance of 1m for construction, a total area of **12m x 6.5m** to be cleared and perfectly levelled.

-Clear area of **12m x 7.5m** if timber propping required. Refer to *Appendix B.1 Component Details*.

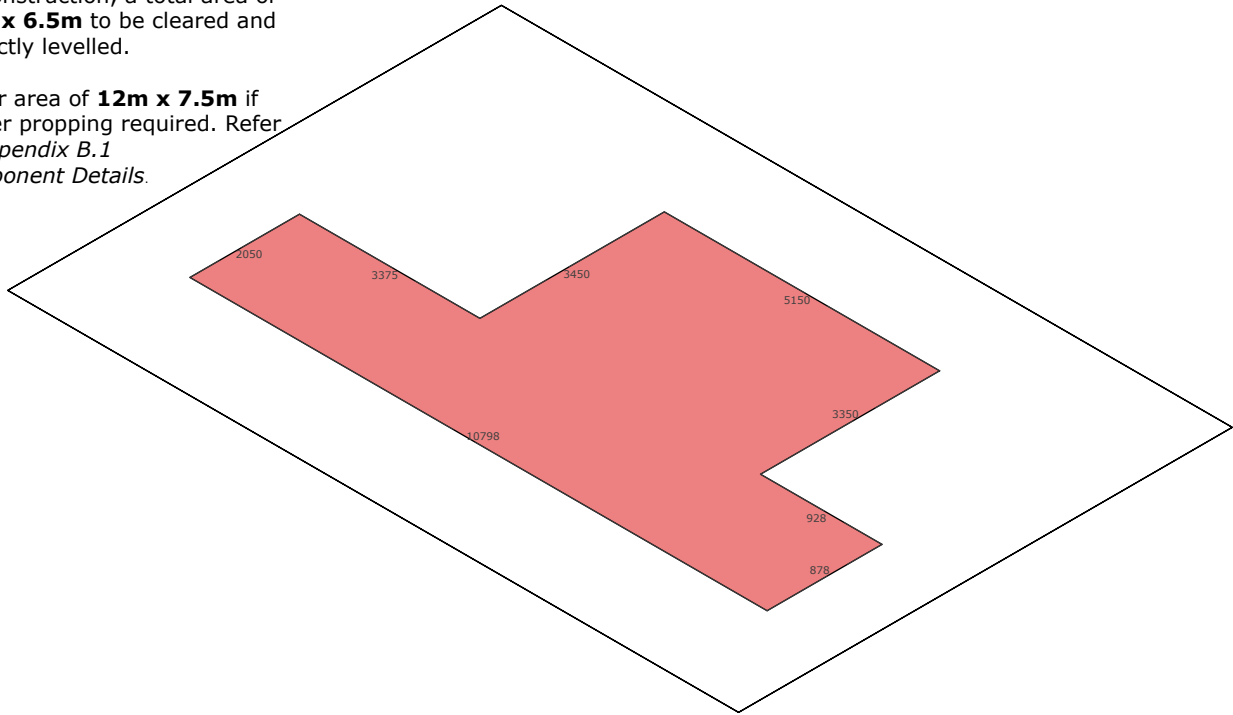

Step 2:
PLATFORM

- Arrange **RL_11** panel along rear and 3x **RL_01** panels as shown bolting panels together at top and bottom for each connection.

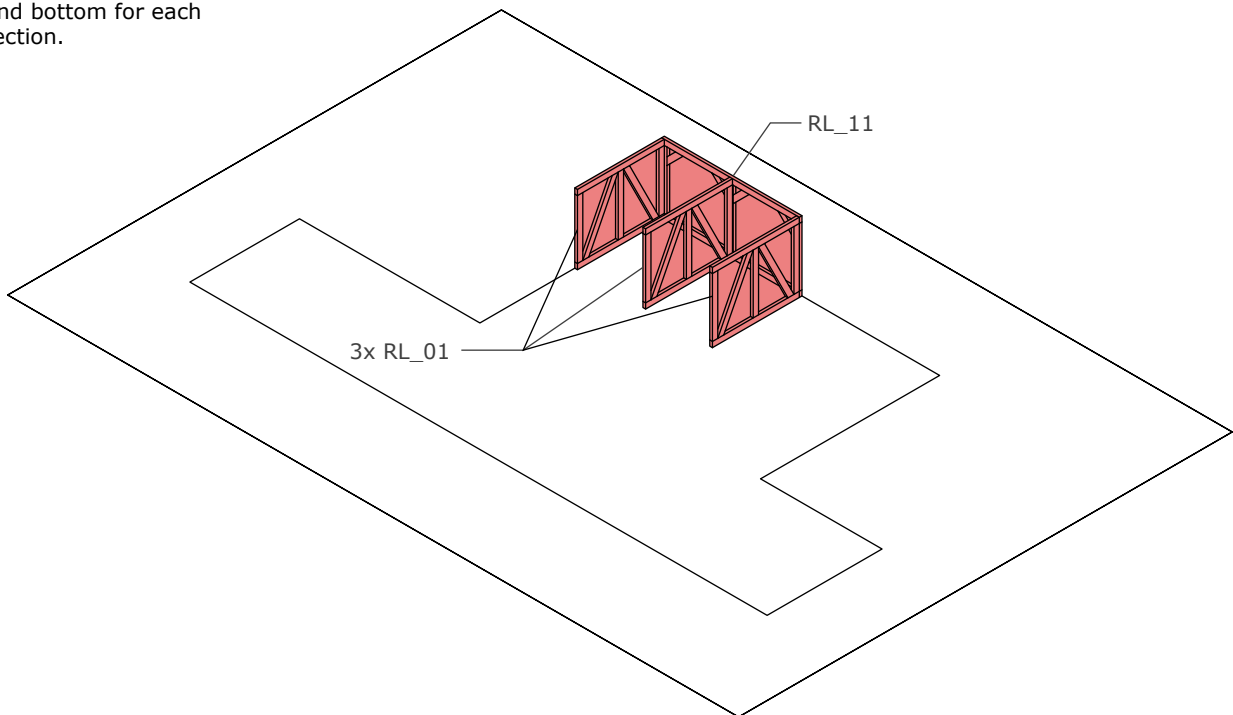

Raised Latrines Block

Step by step

Print to size A4

MARCH 2022

Step 3:
PLATFORM

- Bolt 1x **RL_11** panel to front of panels.

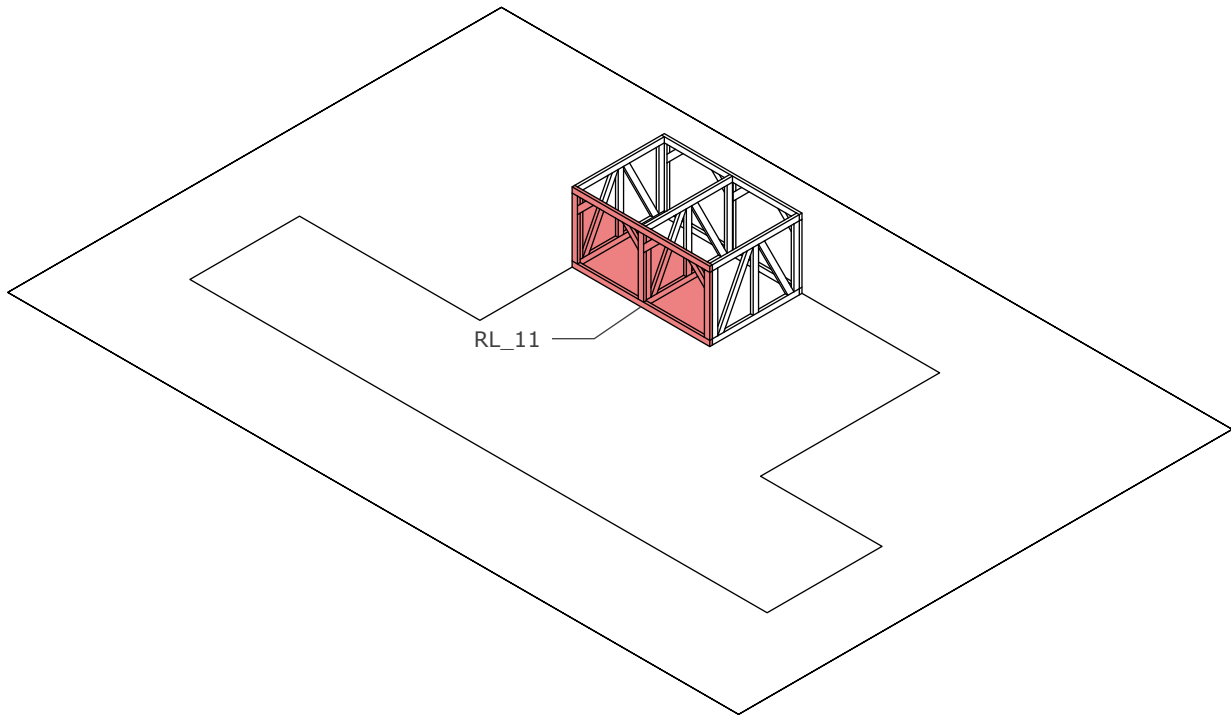
**Step 4:**
PLATFORM

- Repeat the same steps 2 and 3 for 2x **RL_12** panels and 3x **RL_02** panels.
- Connect the two frames together with 4x **M10x22cm**.

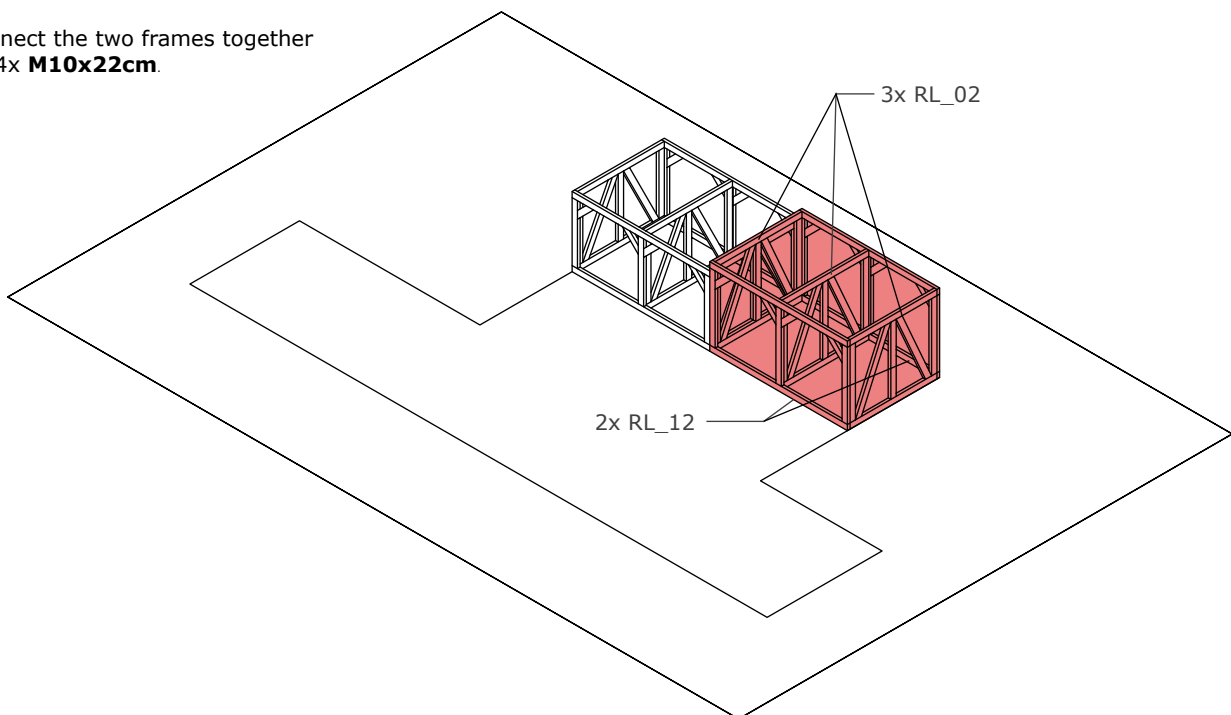
**Raised Latrines Block**

Step by step

Print to size A4

MARCH 2022

Step 5: PLATFORM

- Bolt 5x **RL_03** panels and then add 2x **RL_11** using 4x **M10 x 17cm** and 12x **M10x22cm** bolts. Use the longer bolt thread length for connections through two 100mm timber pieces.

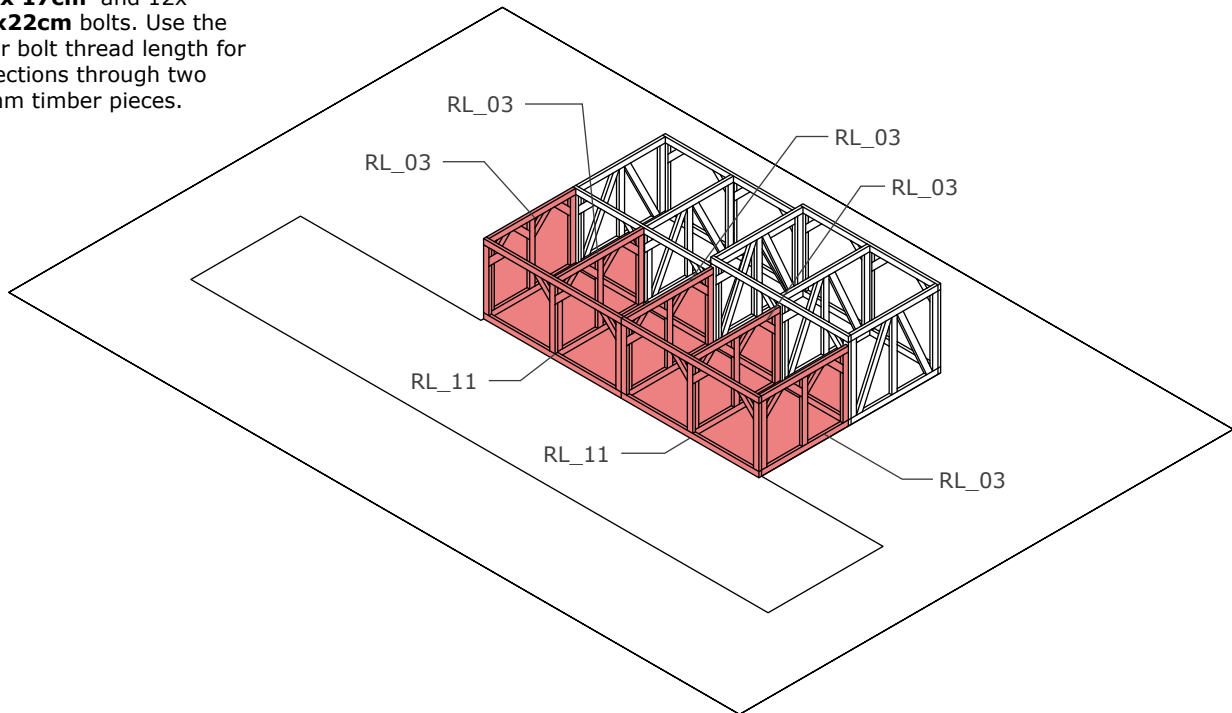

Step 6: PLATFORM

- Add 2x **RL_04** panels and 1x **RL_13** panels with 4x **M10x22cm** and 4x **M10x17cm** bolts. Use the longer bolt thread length for connections of two 100mm timber pieces.

- Install latrine tanks from above.

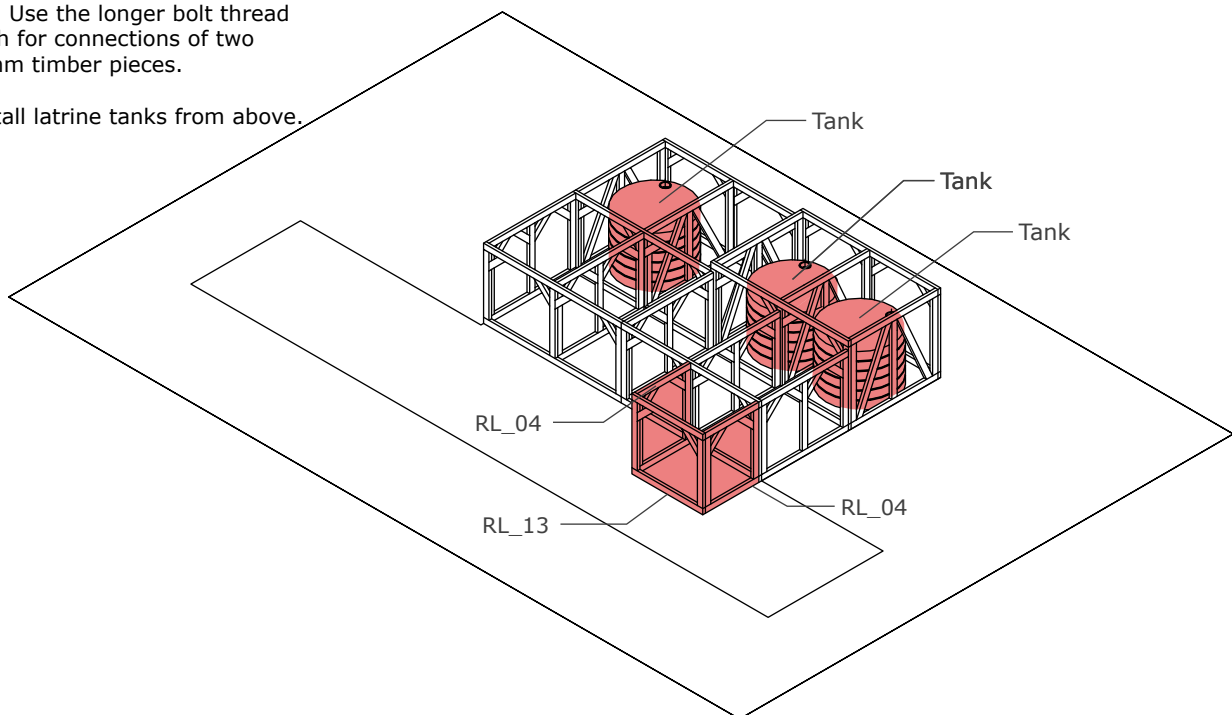

Raised Latrines Block

Step by step

Print to size A4

MARCH 2022

Step 7: PLATFORM

- Add 11x timber planks (6x **RL_P01**, 3x **RL_P02**, 1x **RL_P03**, 1x **RL_P04** and 1x **RL_P05**) as described by each plank reference to complete raised platform frame and screw in place.

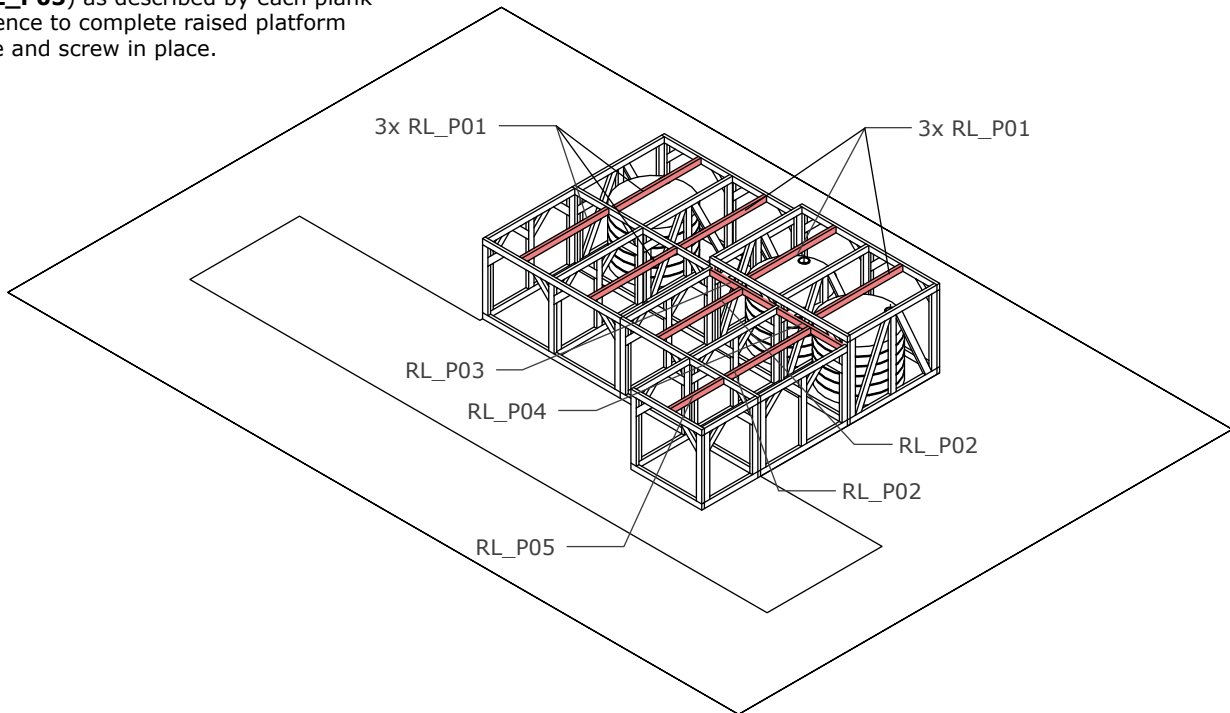

Step 8: RAMP & STAIRS

- Layout and bolt together 4x **RL_21** and 1x **RL_22** panels on the ground and bolt together.

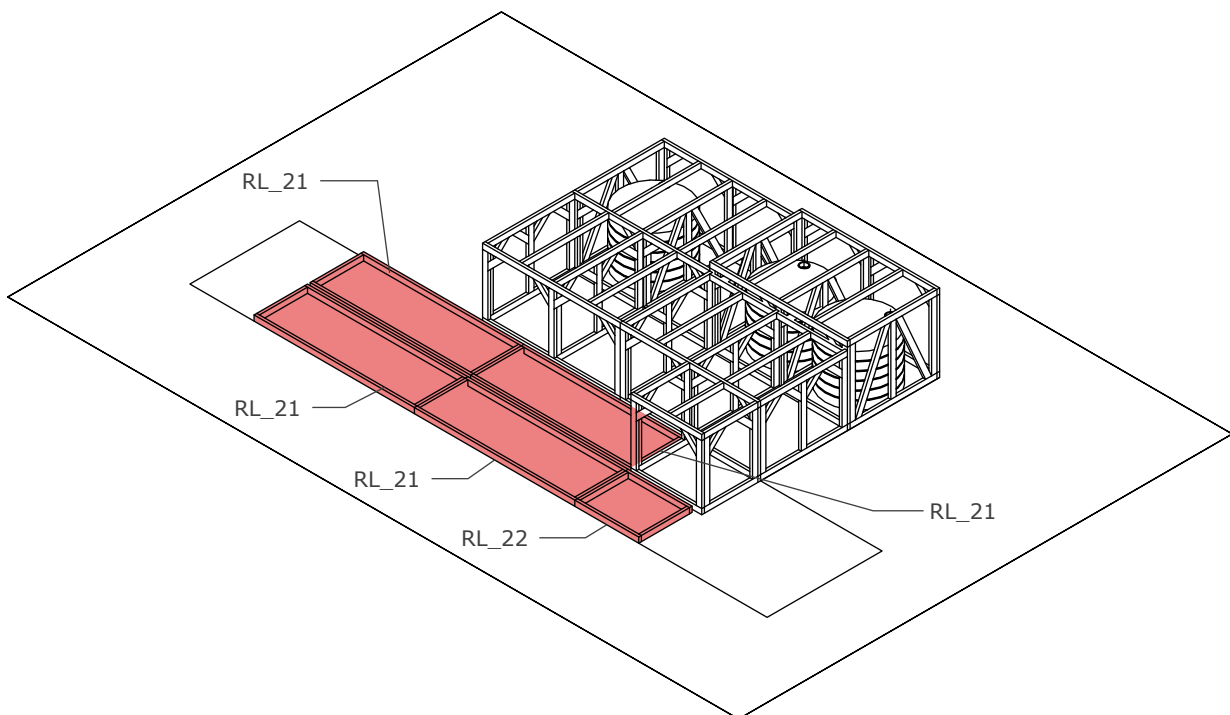

Raised Latrines Block

Step by step

Print to size A4

MARCH 2022

Step 9:
RAMP & STAIRS

- Bolt together 2x **RL_31** and
2x **RL_32** panels as shown.

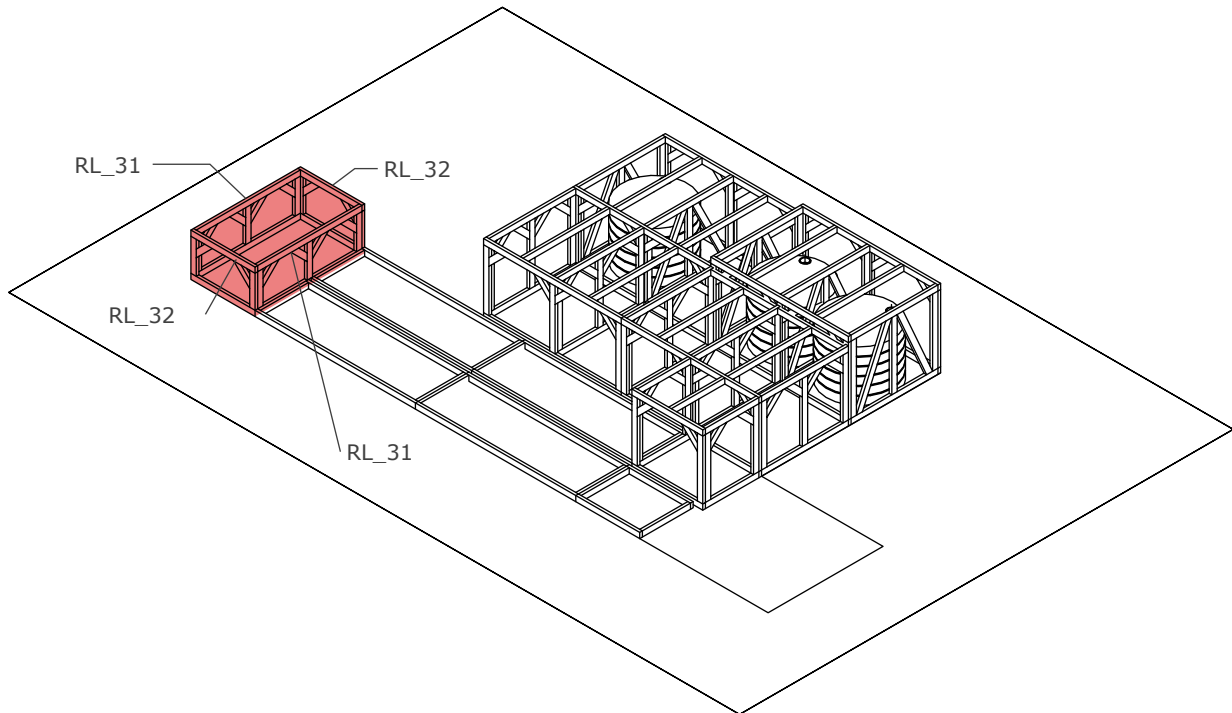
**Step 10:**
RAMP & STAIRS

- Install 3x **RL_P06** wooden
studs as shown and screw in
place.

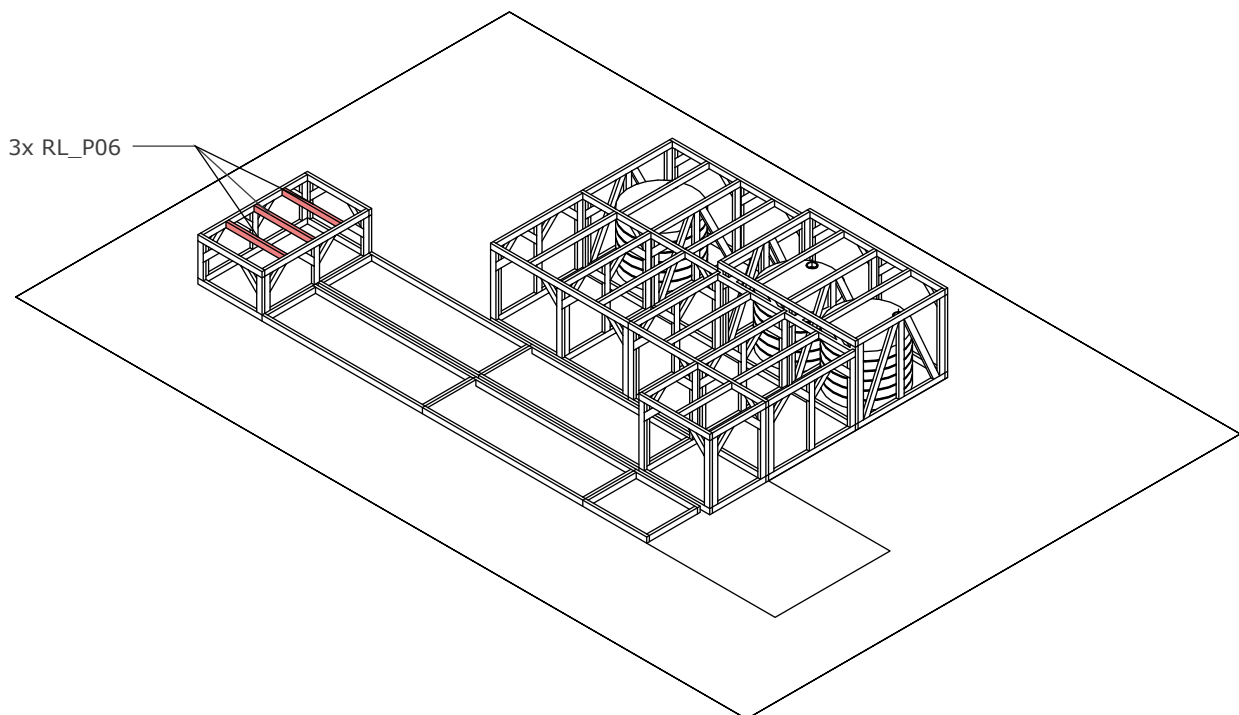
**Raised Latrines Block**

Step by step

Print to size A4

MARCH 2022

Step 11: RAMP & STAIRS

- First install 8x **RL_P07** wooden posts and then install 4x **RL_41** panels and 1x **RL_42**.

- Install 2 x **RL_P08** wooden planks for the sides of the stairs and screw in place.

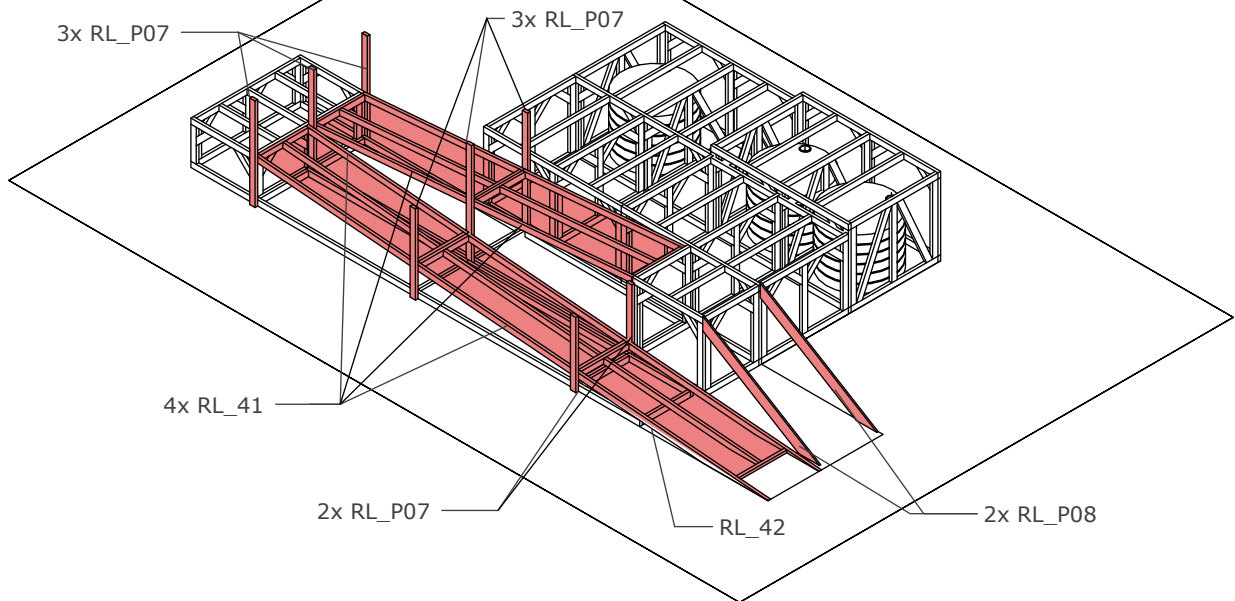

Step 12: RAMP & STAIRS

- Install 30x **RL_P09** vertical posts for the stairs and the ramp and screw in place.

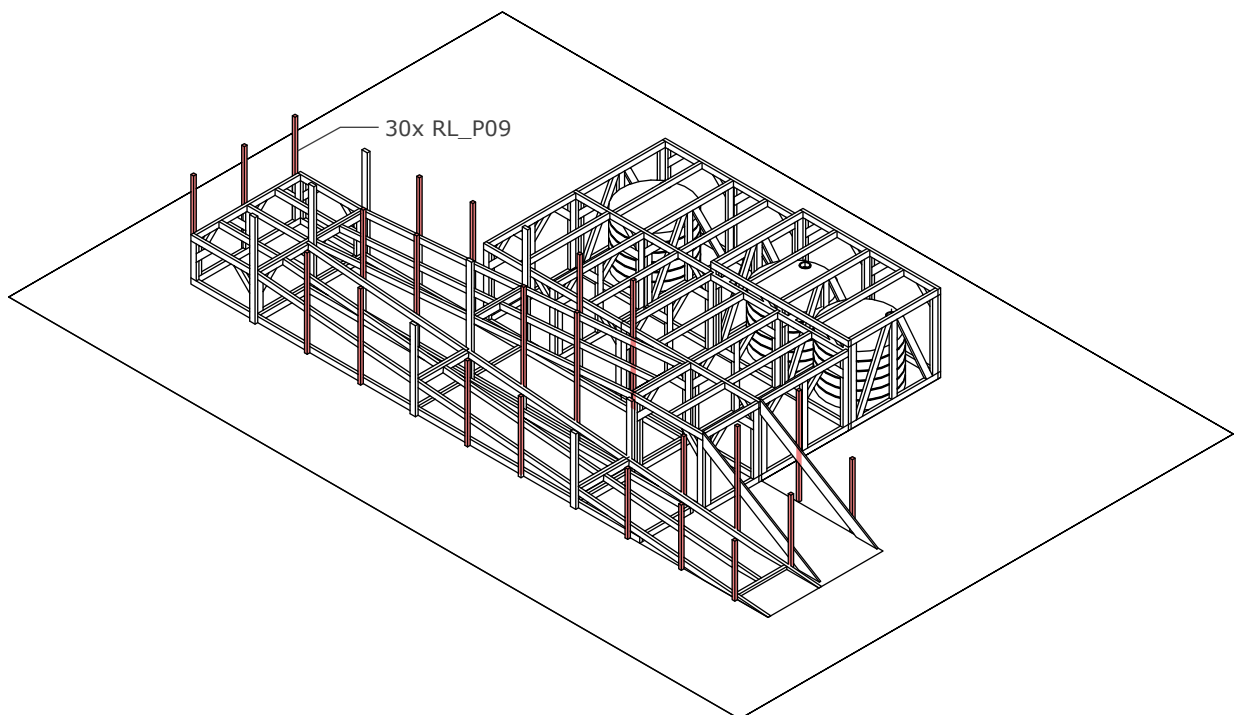

Raised Latrines Block

Step by step

Print to size A4

MARCH 2022

Step 13: TIMBER DECKING

- Install **timber decking planks** across all of the ramp and the raised platform with nails leaving gaps for latrine holes.

- Install 7x **RL_P10** wooden planks for the stairs with wooden screws.

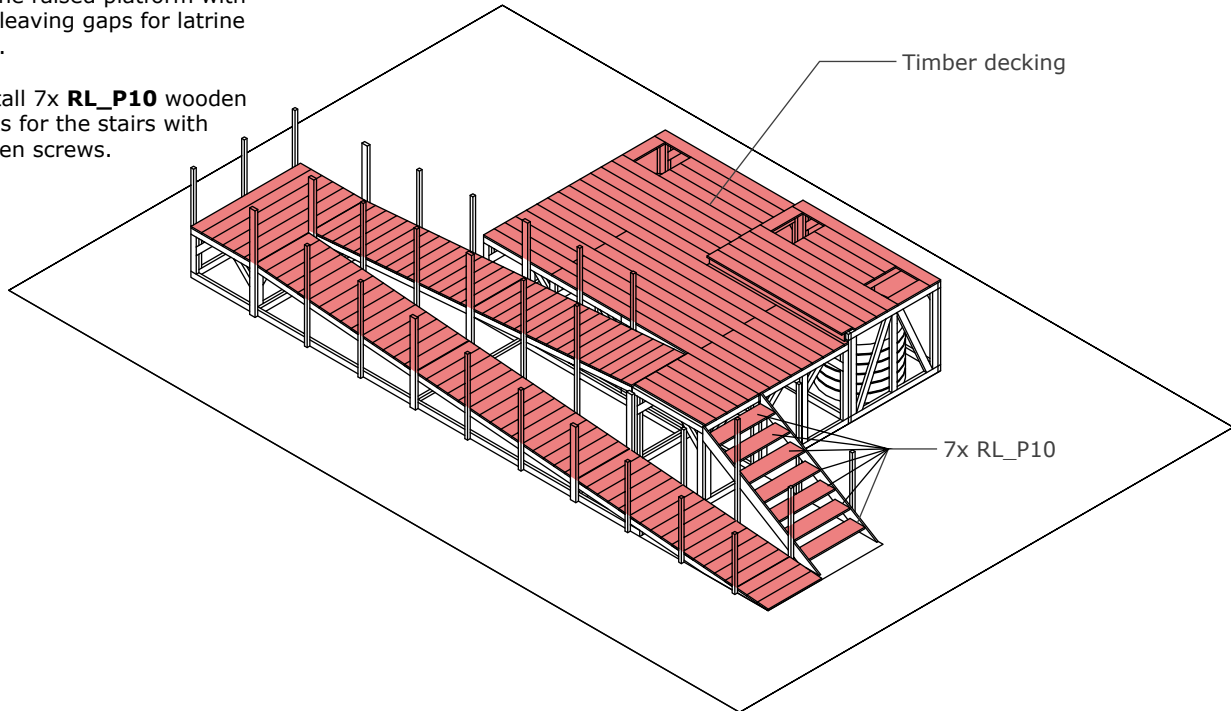

Step 14: RAILINGS

- Install handrail (**RL_P11**) around perimeter of the ramp and the stairs at 600 and 900mm heights from walking surface. Use wood screws to fix in place.

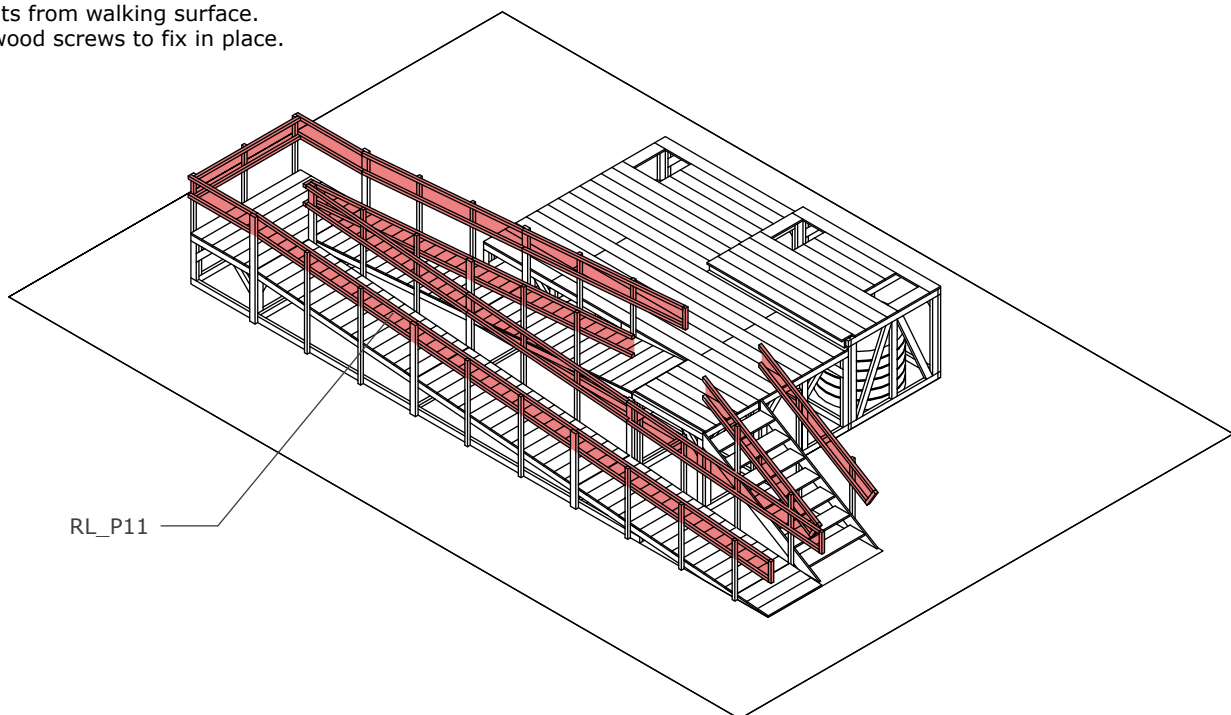

Raised Latrines Block

Step by step

Print to size A4

MARCH 2022

Step 15: LATRINE SLABS

- Place 3x **latrine slabs** in each location and bolt into place with fixing bolts provided.

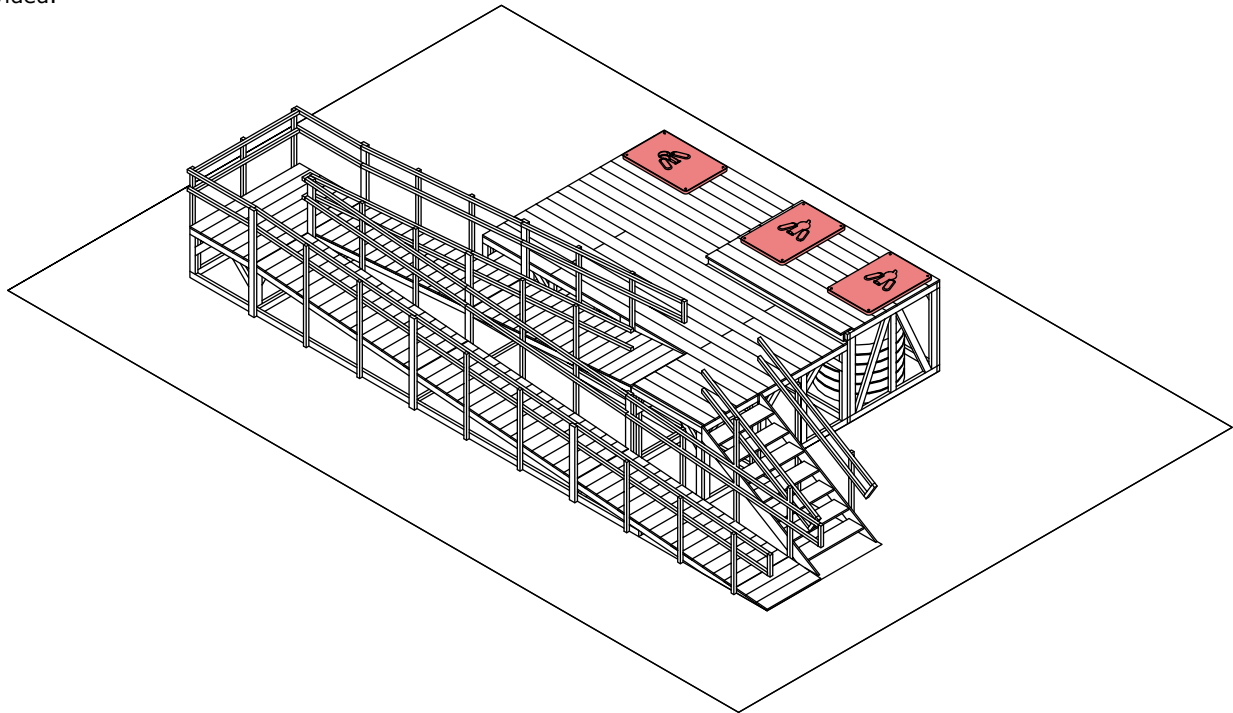

Step 16: CUBICLE PANELS

- Install **cubicle panels** (1x **RL_51**, 2x **RL_52**, 1x **RL_53**, 3x **RL_54**, 1x **RL_55** and 1x **RL_56**) as reference tags indicate starting at the rear of the platform and working forwards. Bolt panels together.

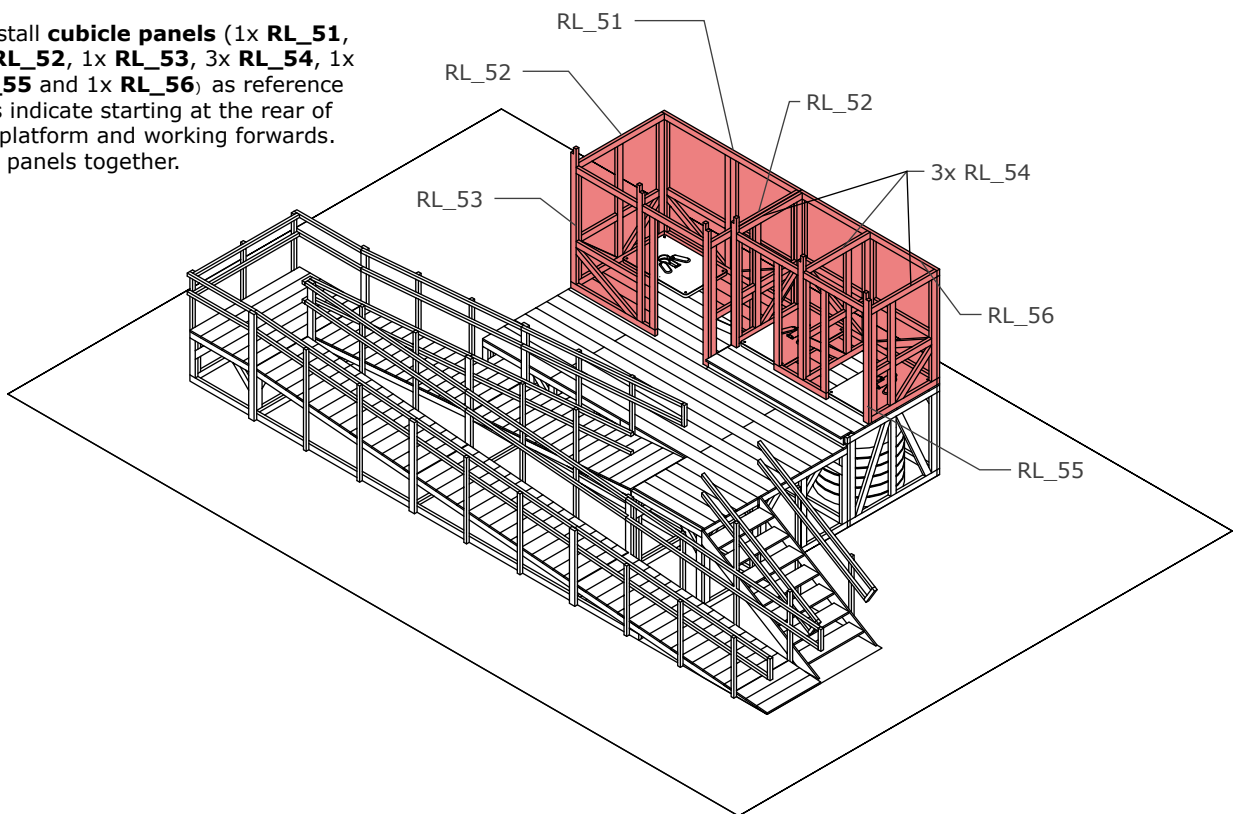

Raised Latrines Block

Step by step

Print to size A4

MARCH 2022

Step 17: SCREEN PANELS

- Install referenced **screen panels** (1x **RL_61**, 1x **RL_62**, 1x **RL_63** and 1x **RL_64**) around the perimeter of the raised platform as shown.

- Install planks 2x **RL_P12** and 2x **RL_P13** and screw in place.

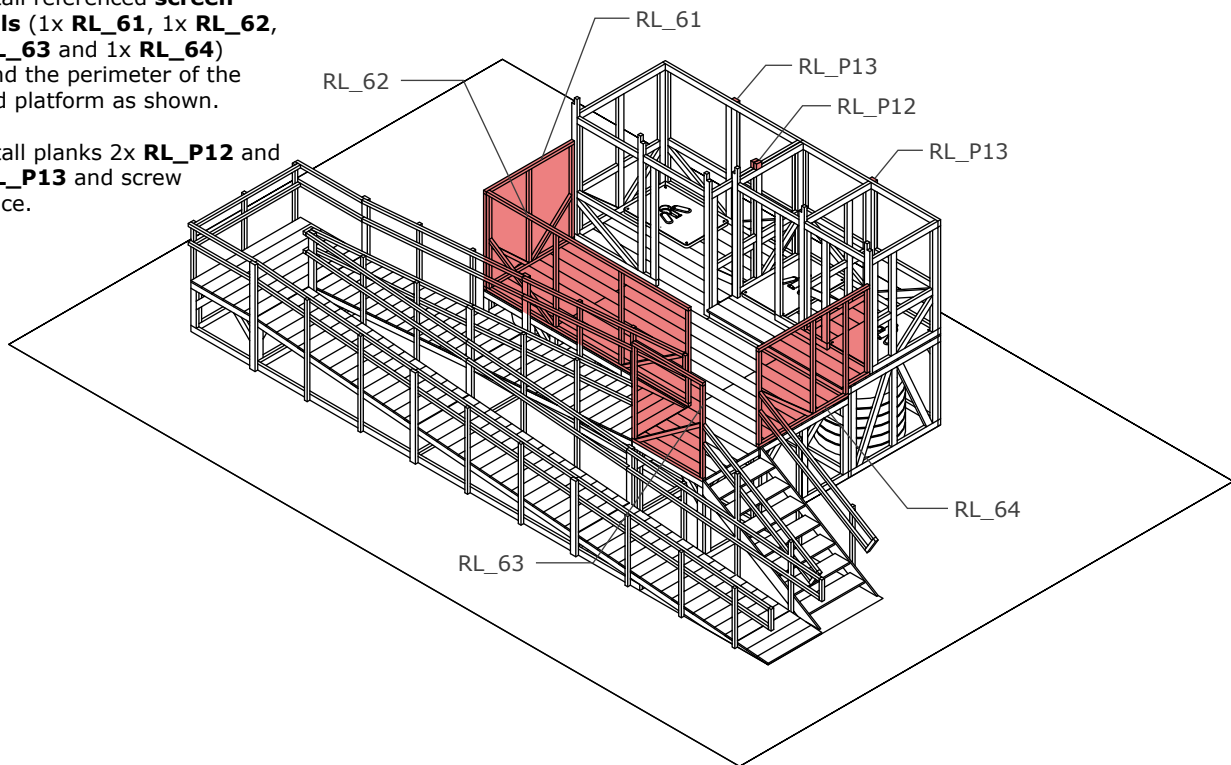

Step 18: ROOF

- Install 6x horizontal timber **RL_P14** roof supports on top of the cubicles and screw in place.

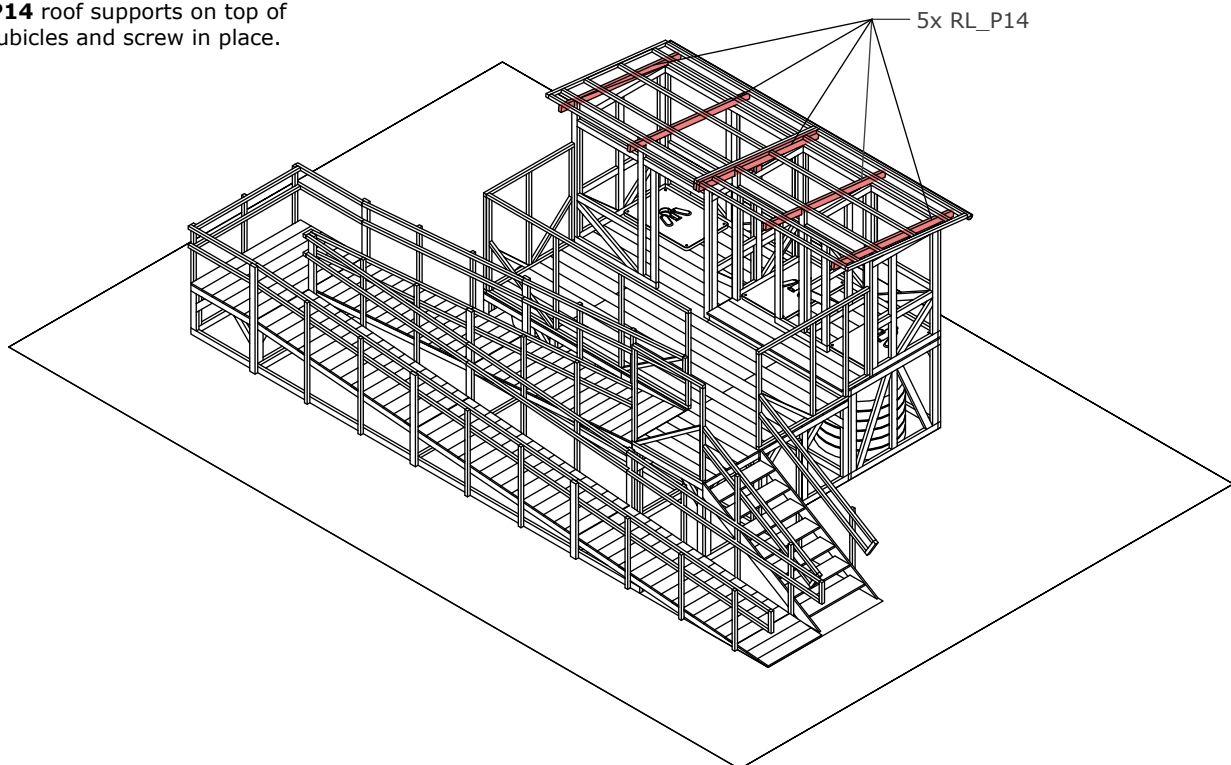

Raised Latrines Block

Step by step

Print to size A4

MARCH 2022

Step 19:
ROOF

- Install 2x **RL_71** roof panels to top of the cubicles bolting together.

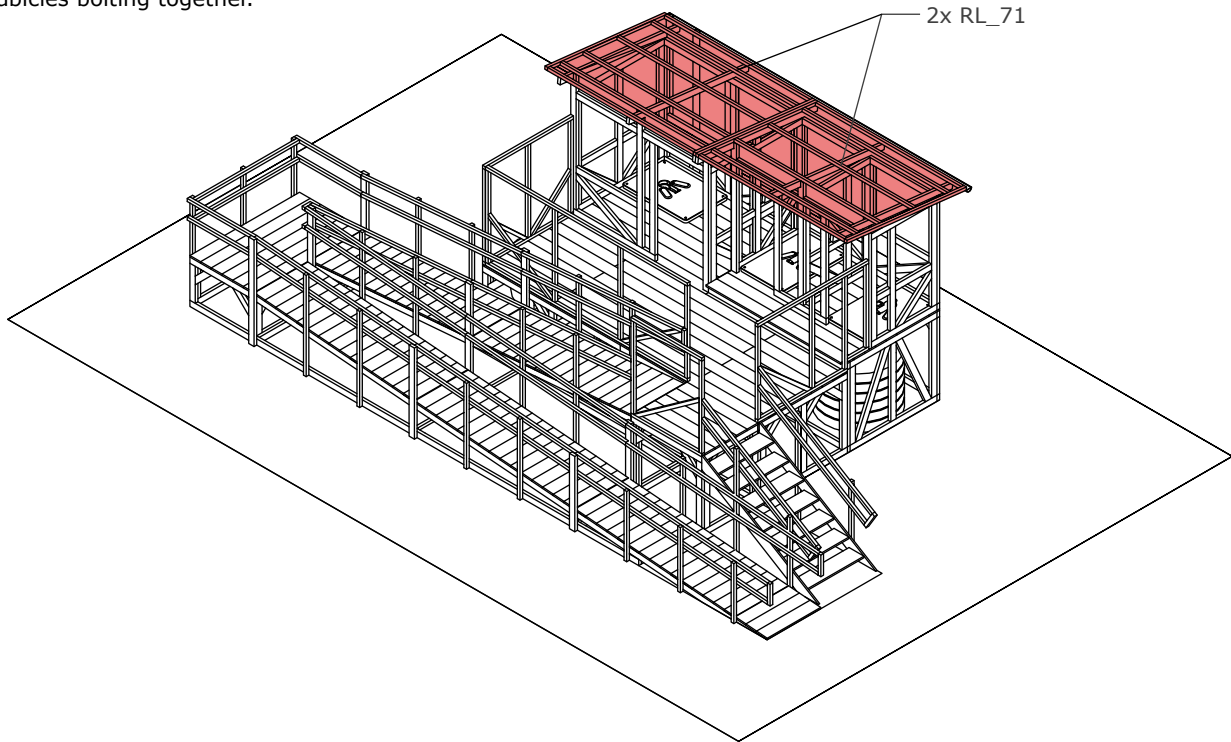
**Step 20:**
CUBICLE PANELS

- Install cubicle doors x2 **RL_72** and 1x **RL_73**
- Install **plastic sheeting** with domed head nails around cubicles, screens and roof panels.
- Install equipment as detailed in cubicle plans.

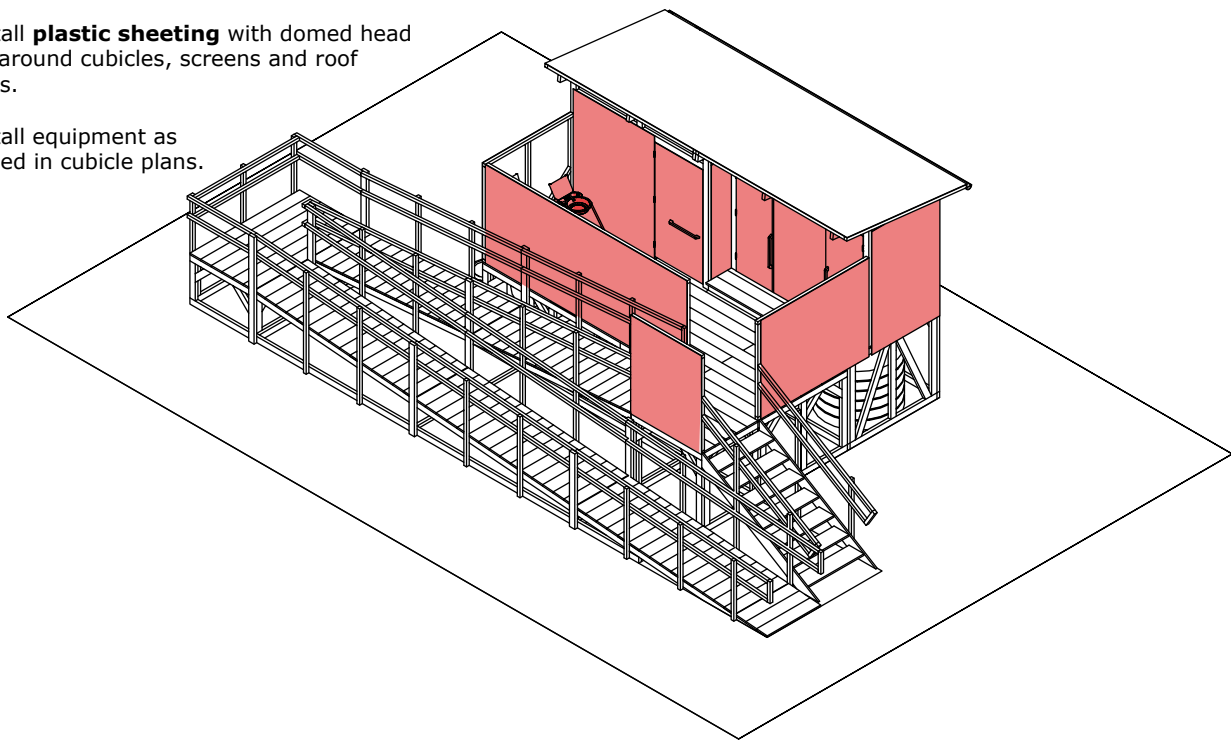
**Raised Latrines Block**

Step by step

Print to size A4

MARCH 2022

8 Template Design 3: Bathing Block

This design is based on UNHCR, WASH Manual D700-2015a: Emergency Communal Shower.

This design is a temporary MHM and disability-friendly bathing block, with a maximum design lifespan of 5 months. The design is suitable for different contexts, including sites with high groundwater table or rocky soil. It does not require excavation.

The bathing block is composed of two general cubicles and one accessible cubicle. Access is provided by a ramp and stairs. The design incorporates all the elements highlighted in the previous section, including elements that allow washing of reusable menstrual material and a drying area for them to sun-dry.

Key points to note prior to procurement and construction:

- Use the guidance provided in Sections A & B of this manual to carry out assessments for context specific adaption including:
 - User Consultation ([IFRC MHM Guide & Toolkit](#))
 - Site assessment (see [Site Checklist](#))
- Review the BOQ and substitute locally available materials and equipment where appropriate.
- Take note of the connection details and provide appropriate instruction to the construction team:
 - Timbers to be joined using four small wood screws per connection within a panel. Use four small wood screws per connection for each plank connection.
 - Panels to be bolted together for ease of storage, assembly, disassembly, moving and reuse in new locations.
 - Two bolt thread lengths have been specified in the BOQ (17cm and 22cm) to be used when connecting two timber pieces 5cm+10cm and 10cm+10cm respectively with a washer. In the step-by-step construction sequence, unless specified a 17cm bolt thread length should be used to connect panels together.

8.1 Bathing Block Bill of Materials

Ref	Item	Quantity	Unit	Notes
1	Timber			
1.1	Wooden Posts (4m x 5cm x 5cm) Strength class C16, Density 4 to 6kN/m ³	40	pc	For screen's frame, doors' frame, handrails, ramp
1.2	Wooden Beams (4m x 10cm x 5cm) Strength class C16, Density 4 to 6kN/m ³	75	pc	For raised platform structure and cubicle framing
1.3	Wooden Planks (4m x 20cm x 2.5cm) Strength class C16, Density 4 to 6kN/m ³	50	pc	For floor, ramp, stairs and shelves
2	Fixings & Hardware			
2.1	Small wood screws (6mm x 150mm or equivalent No. 12 5.59mm diameter)	10.5	kg	4 wood screws at each connection location within a panel. 880 screws total
2.2	Nails (14cm Galvanized)	5	kg	To secure walking planks. 150 nails total
2.3	Domed Head Nails (4cm Galvanized)	4	kg	To fix plastic sheeting – every 30 cm or less. 1144 nails total
2.4	Metal Bolts and Washers (M10 x 17cm)	64	pc	To join cubicle panels
2.5	Metal Bolts and Washers (M10 x 22cm)	12	pc	To join platform panels
2.6	Metallic self-closing Door Hinge (4cm x 8cm x 2mm Galvanized)	9	pc	3 per door. If they are not available use normal hinges and use self-closing springs
3	Cladding			
3.1	Plastic Sheetting / Tarpaulin To meet the international minimum humanitarian standards (200g/m ² 700N tensile strength, UV stabilised laminated woven or braided mesh of black high-density polyethylene between two white layers of low-density polyethylene)	91	m ²	For walls, doors, and roof.
3.2	Mosquito net	5	m ²	For ventilation gaps in cubicles and the drying boxes
4	WASH Components			
4.1	Butyloo XPHABS. Premade polymer resin shower plate - 1200x 800 x 45mm with dia 90 Waste	3	pc	For general and accessible toilets.
4.2	150 mm diameter pipe	2	m	For disposal system
4.3	150L tank	2	pc	For the disposal system
4.4	PVC P-trap 40 mm	3	pc	For drainage system
4.5	PVC drainage pipe 40mm	3	m	For drainage system
4.6	PVC drainage pipe 90mm	6	m	For drainage system. Length will be determined by the drainage system proposed on site
4.7	PVC Tee pipe connector from 40 mm to 90mm	2	pc	For drainage system
4.8	Union elbow connector from 40mm to 90mm	1	pc	For drainage system

Ref	Item	Quantity	Unit	Notes
5	Fixtures & Fittings			
5.1	Door locks – door bolt type 4cm long	3	pc	For doors in the 3 cubicles
5.2	Wooden Grab Rails and Door Handles (Minimum 500mm Length)	9	pc	For the door both sides and one inside each cubicle
6	Accessories			
6.1	20 L Bucket with lid and ladle	3	pc	One in each cubicle to provide water inside
6.2	Hanging bell	3	pc	One in each cubicle
6.3	Hooks	6	pc	Two in each cubicle
6.4	Padlock	2	pc	To lock the tank of the disposal system
6.5	300x 800 mm mirror	3	pc	One in each cubicle
6.6	150 mm diameter lid (for top of 150mm pipe)	3	pc	For the disposal system
6.7	Nylon rope	9	m	For drying lines
6.8	Hair sieve	3	pc	For shower drain
6.9	Stainless steel and wood frame washing board max 350 x240 mm	3	pc	For washing the menstrual material inside the cubicles
7.0	Shower seat - chair with seat area minimum 400x450 mm and maximum seat height 450mm	1	pc	For accessible cubicle

ANCHORING OF LATRINE BLOCK FOR WINDSPEEDS >25M/S

Requirement for the following depends on site conditions:

Ref	Item	Quantity	Unit	Notes
A1.1	Wooden studs (4m x 10cm x 5cm) Strength class C16, Density 4 to 6kN/m ³	10	pc	Timber propping
A1.2	Small wood screws (6mmx 150mm or equivalent No. 12 5.59mm diameter)	200	pc	

Key Notes on the BOQ:

All items may be substituted with alternatives (ready-made or locally fabricated) provided they are of equivalent performance and size. The field team is responsible for checking details of dimensions and connections for compatibility with the facility as designed, making any adaptations required to accommodate the substitution.

The **strength class of the timber planks** for this design is C16 (C for coniferous) referred to in Eurocode 5 and graded in accordance with BS EN 14081. Please refer to Section 9.3.1 for further information on the structural specification of the timber required for the latrine block.

Additional items requiring local / site specific selection

The field-team should consider site specific conditions that might require additional elements to be specified and procured. Blank rows are included at the end of the BOQ to allow for these additions. This may include for example:

- **LIGHTING:** The lighting solution has not been included as it should be specific to each site, and developed in consultation with the user groups. The field team will need to consider what

8.2 Bathing Block Architectural Drawings and Visualisations

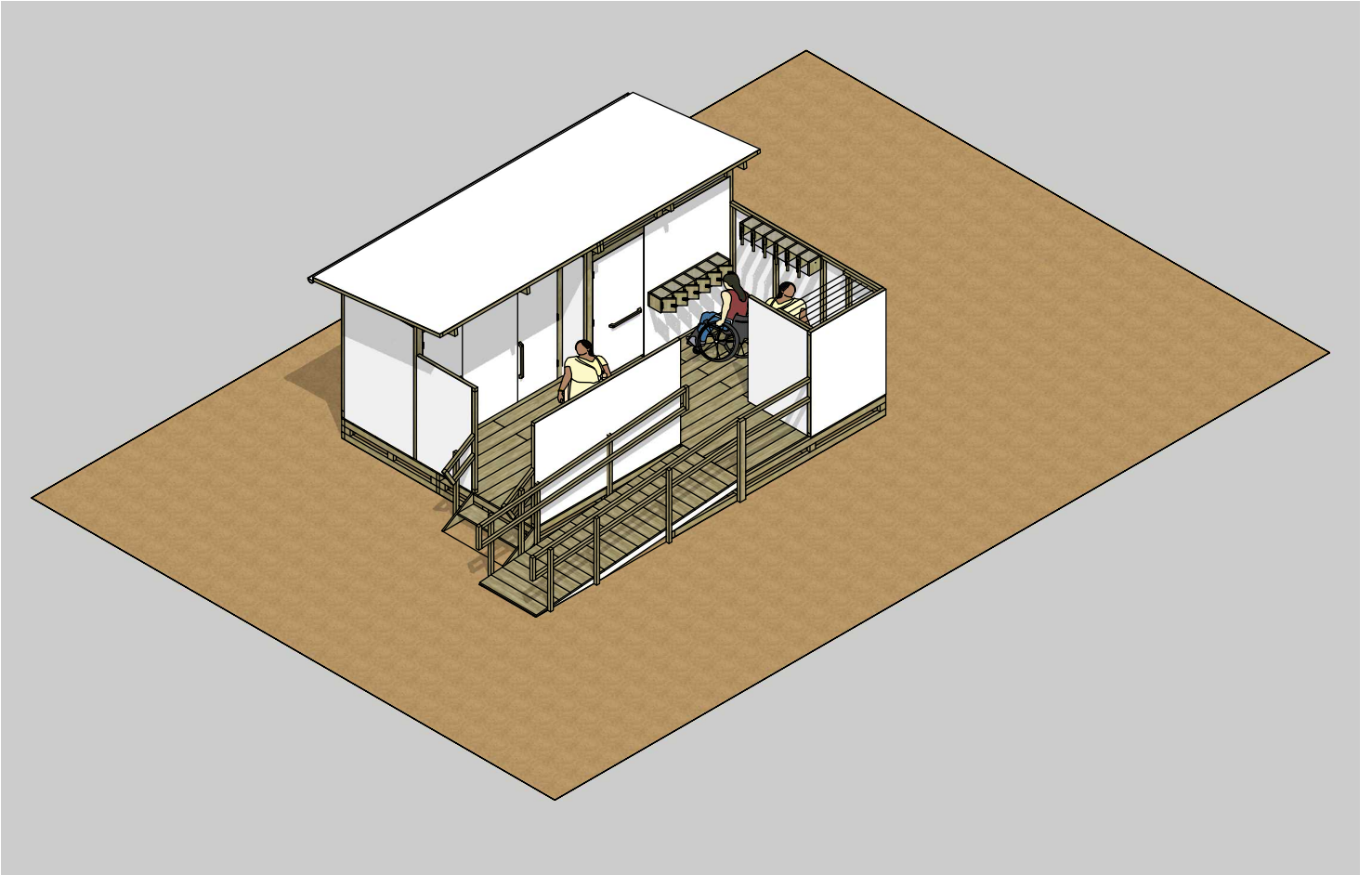

Bathing Block
Isometric view

Bathing Cubicle
Plan 1:50

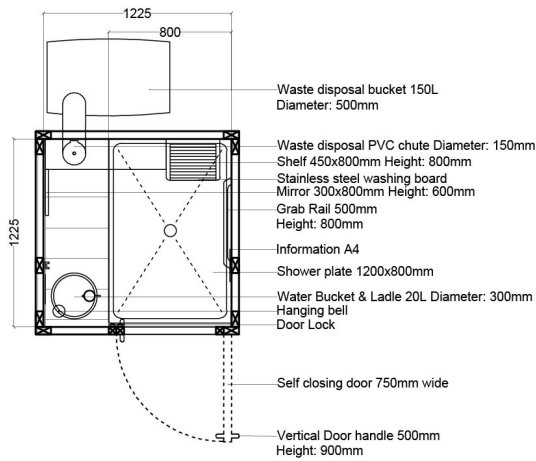

Bathing Cubicle PRM
Plan 1:50

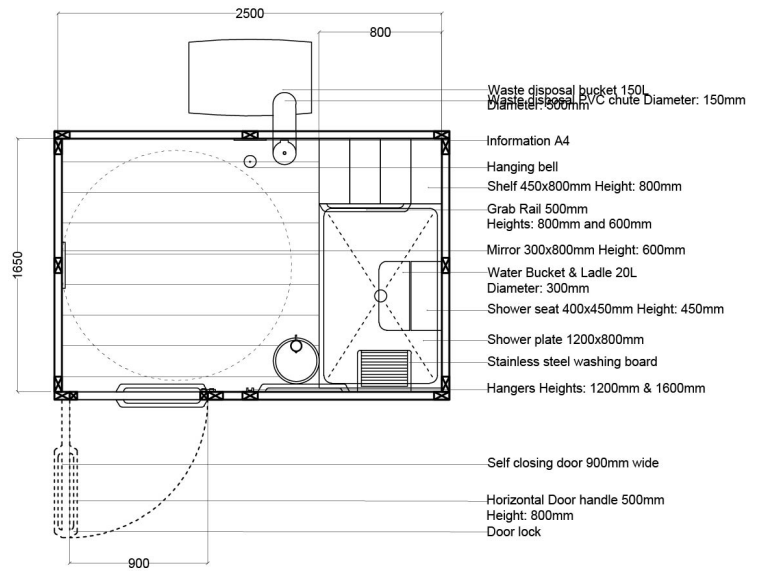

Bathing Cubicle
Section 1:50

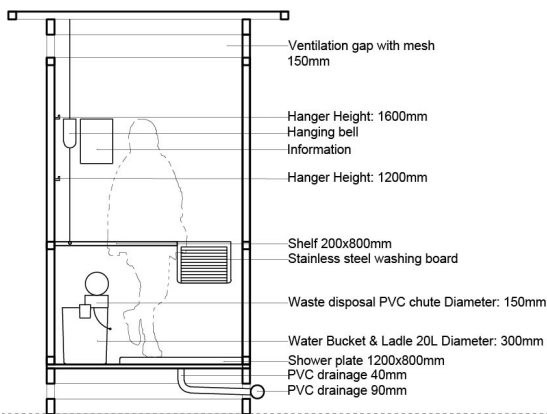

Bathing Cubicle PRM
Section 1:50

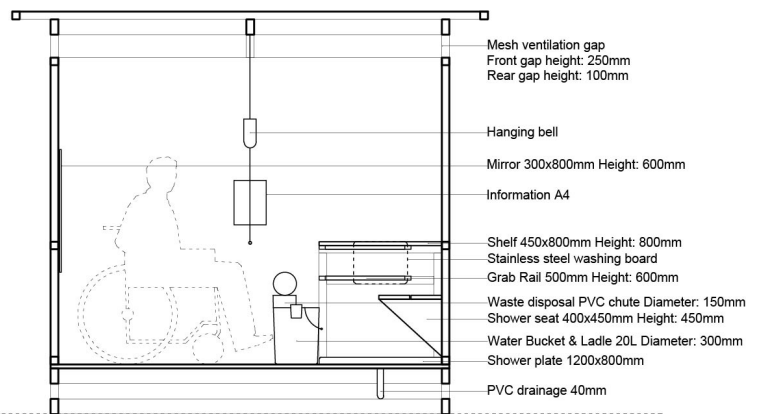

Support Structure Plan

1:50

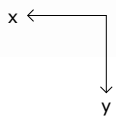
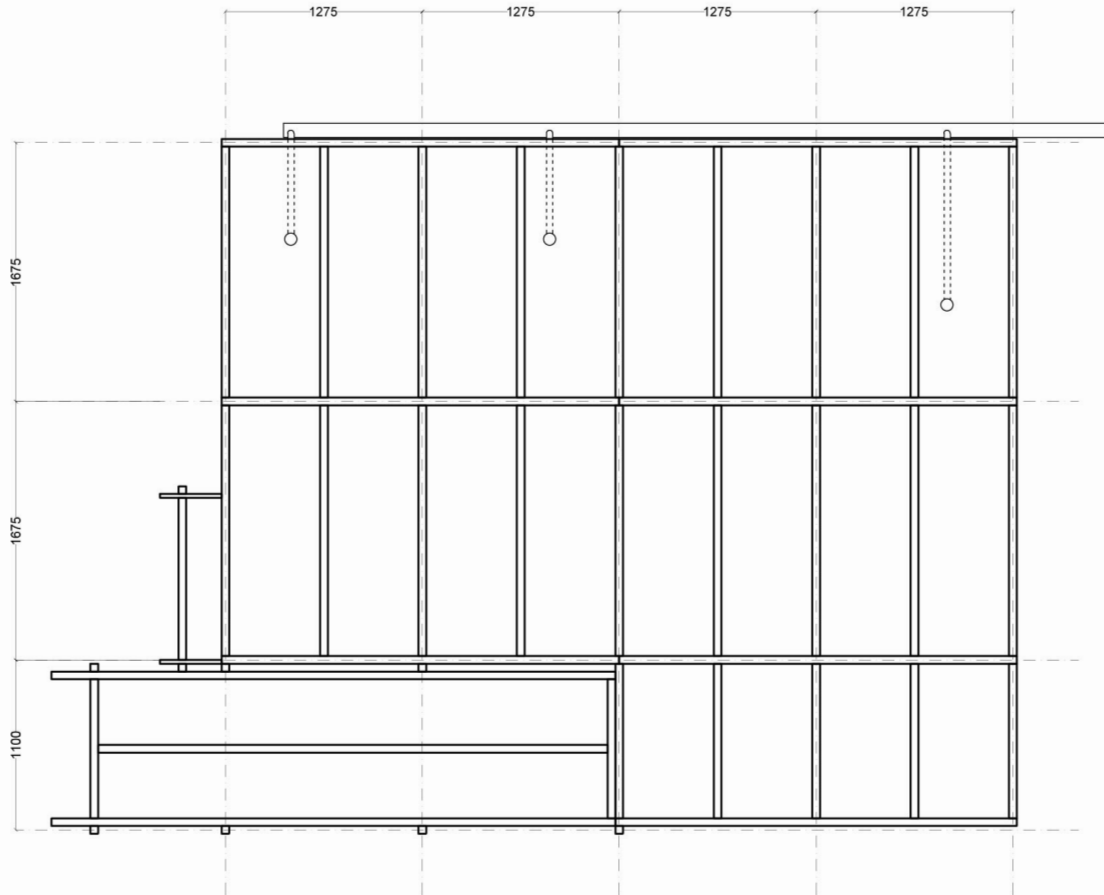

Bathing Block

Plan

Print to size A4

MARCH 2022

Front View

1:75

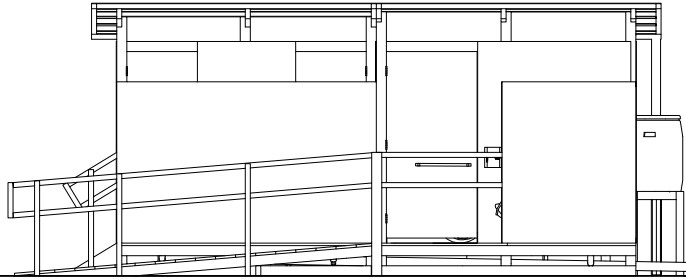
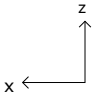

Rear View

1:75

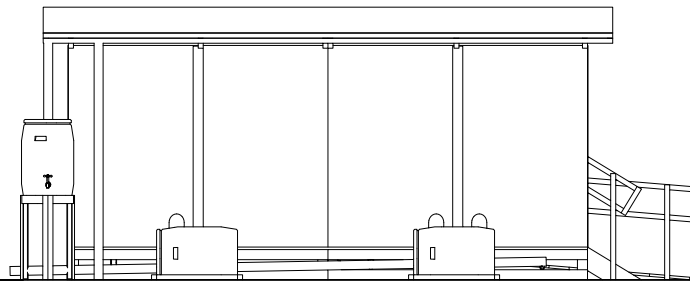
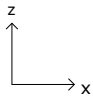

Side View

1:75

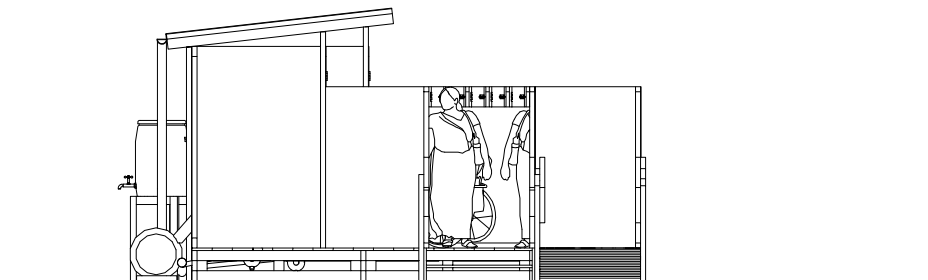

Bathing Block
Elevation Views

Longitudinal Section View

1:75

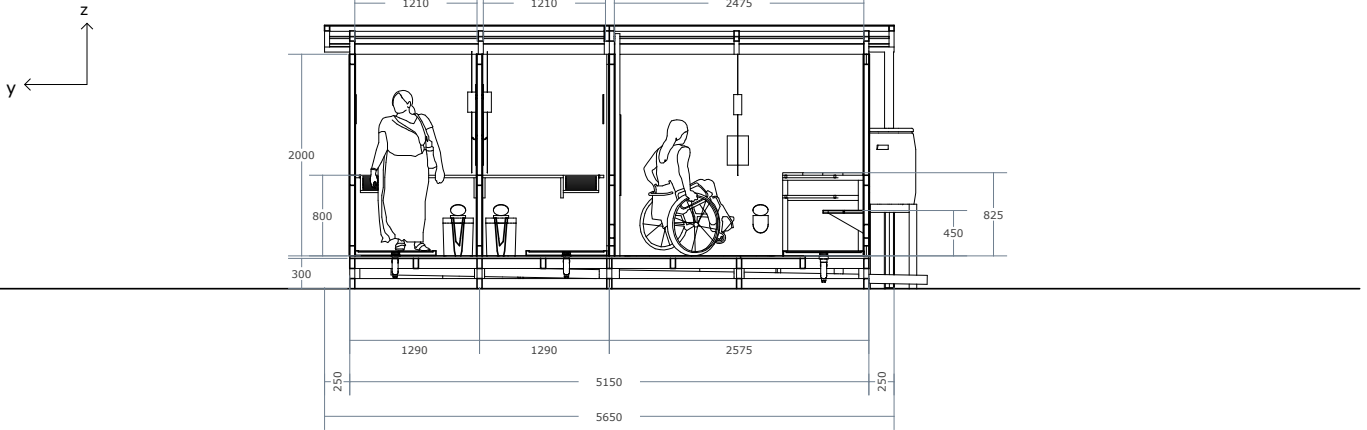

Cross Section View

1:75

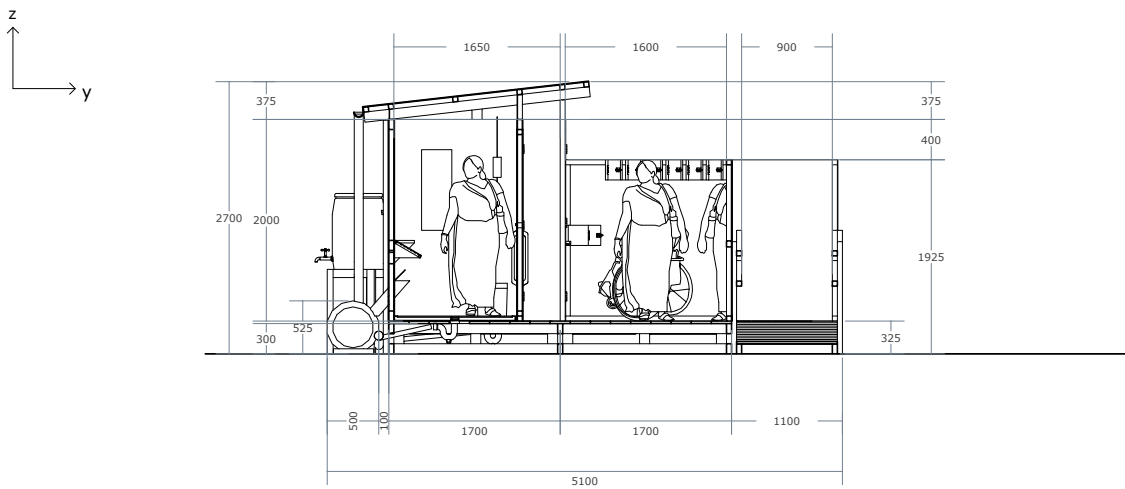

Ramp & Stairs Elevation

1:75

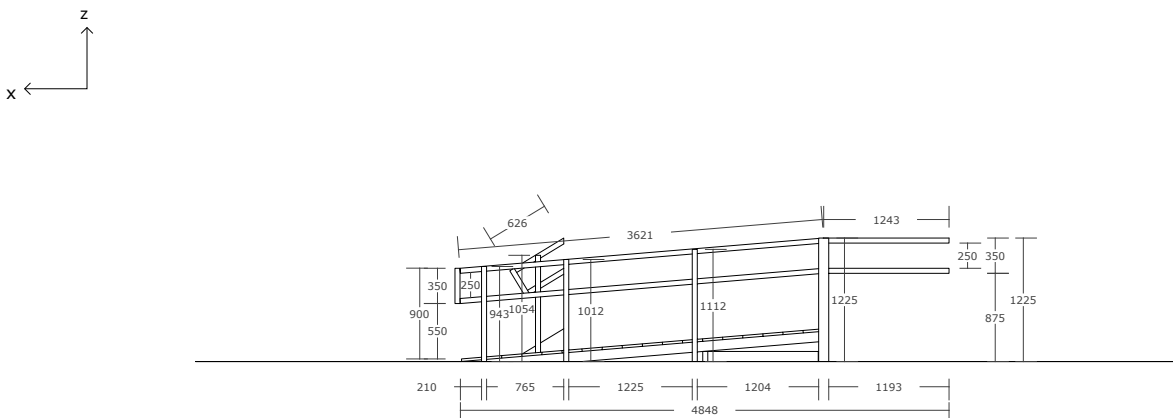

Isometric Front View

1:100

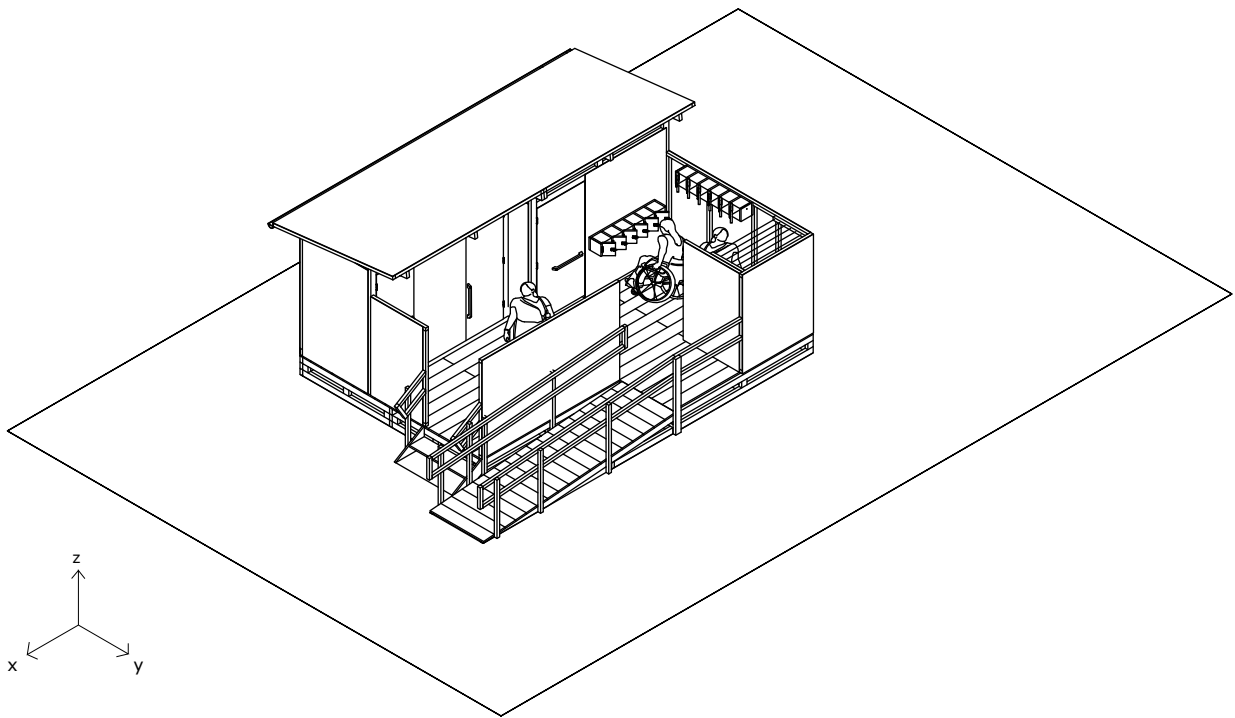

Bathing Block

Isometric views

Print to size A4

MARCH 2022

Isometric Below View

1:100

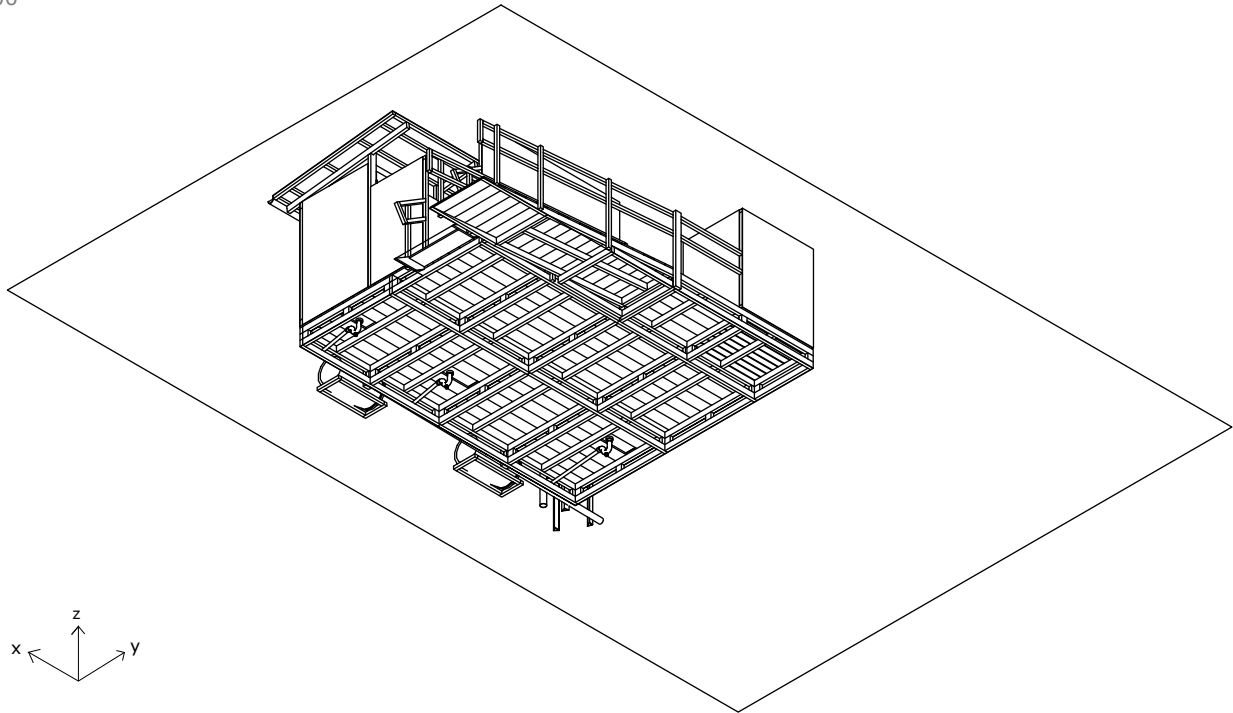

8.3 Bathing Block Panel Lists & Diagrams

Panel List

Bathing Block - BB

Panel reference code	Number required
BB 01	7
BB 02	10
BB 03	3
BB 11	1
BB 12	1
BB 51	2
BB 52	2
BB 53	1
BB 54	3
BB 55	1
BB 61	1
BB 62	1
BB 63	1
BB 64	1
BB 65	1
BB 71	2
BB 72	2
BB 73	1

Plank List

Bathing Block - BB

Plank reference code	Section	Length (mm)	Number required	Reference
BB P01	50x100	1625	8	Platform
BB P02	50x100	1000	2	Platform
BB P03	25x200	630	2	Stairs
BB P04	25x200	1050	1	Stairs
BB P05	50x100	2300	2	Cubicle frame
BB P06	50x100	2010	1	Cubicle frame
BB P07	50x100	1225	1	Handrail
BB P08	50x50	Ramp height + 925mm	8	Handrail
BB P09	50x50	Refer to ramp elevation		Handrail
BB P10	50x100	2250	6	Roof

Bathing Block

Lists of panels and planks

Print to size A4

MARCH 2022

Platform Frames

Timber 50x100mm - 1:50

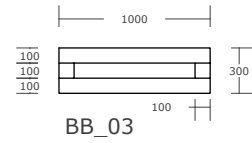
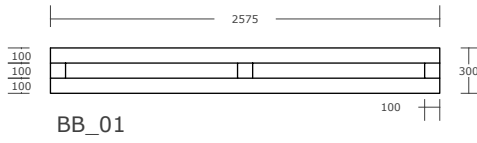
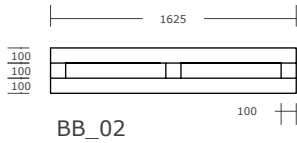

Ramp Frames

Timber 50x100mm - 1:50

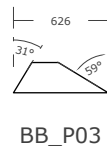
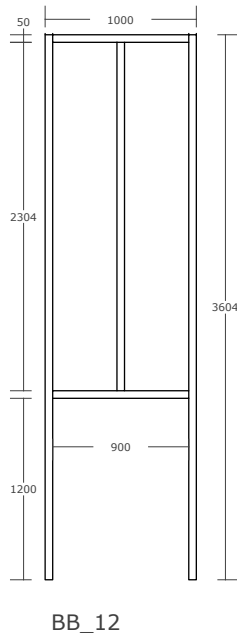
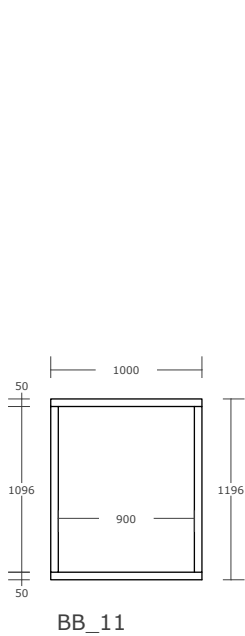

Ramp Floor Boards

Timber 25x200mm - 1:50

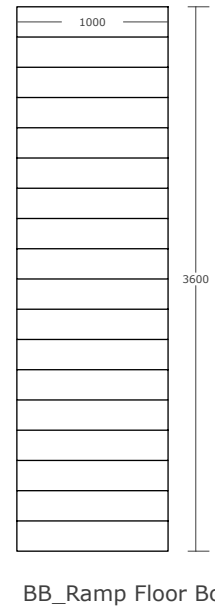

Bathing Block

Details

Print to size A4

MARCH 2022

Platform Floor Boards

Timber 25x200mm - 1:50

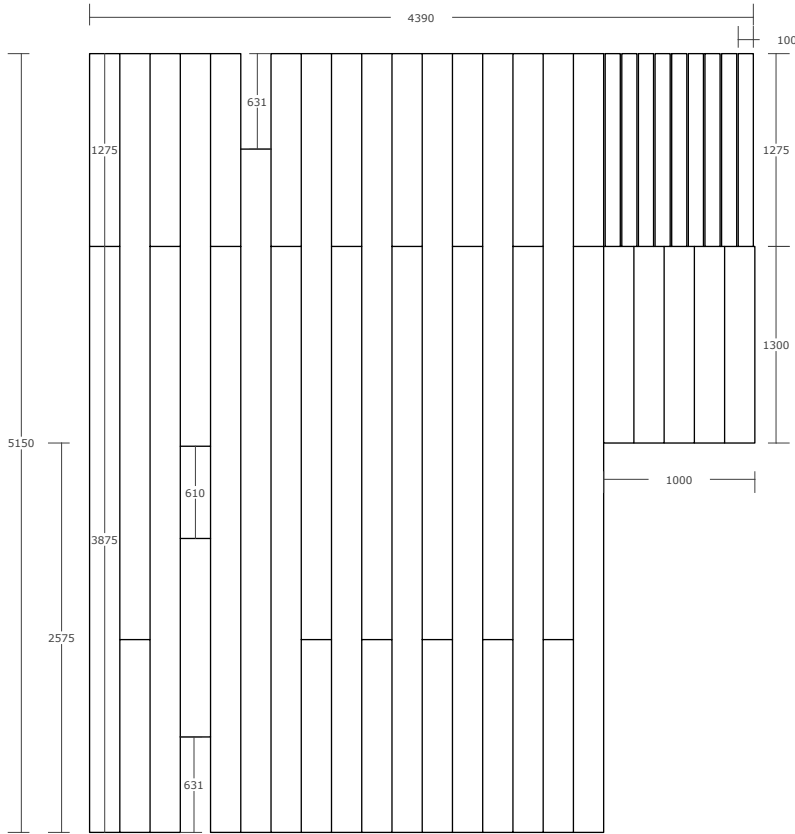

BB_Platform Floor Boards

Cubicle Panels

Timber 50x100mm - 1:50

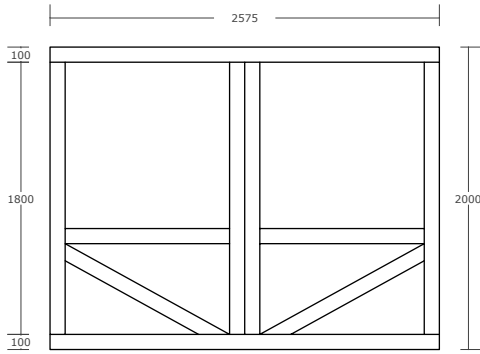

BB_51

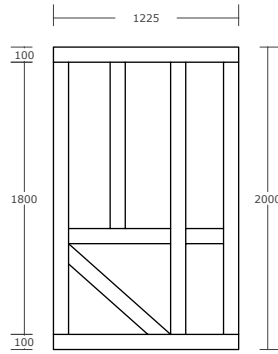

BB_54

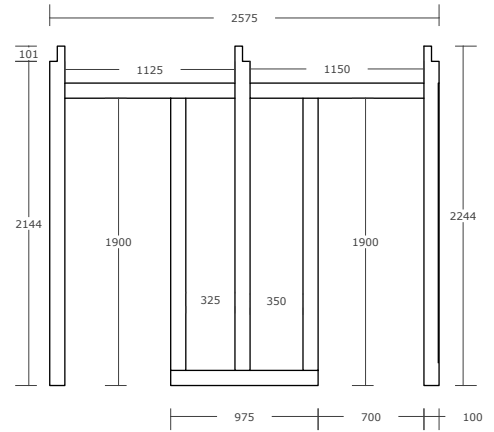

BB_55

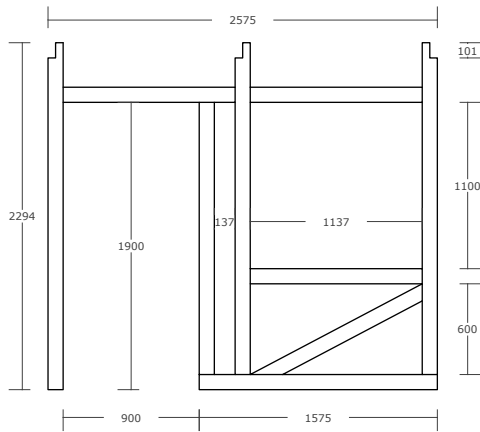

BB_53

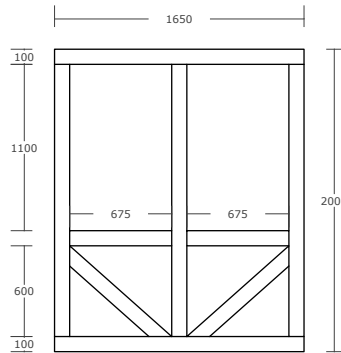

BB_52

Bathing Block

Details

Print to size A4

MARCH 2022

Platform Screen Panels

Timber 50x50mm - 1:50

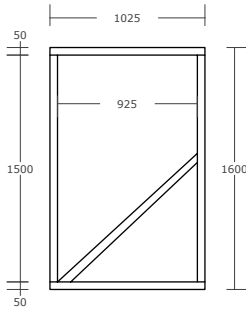

BB_61

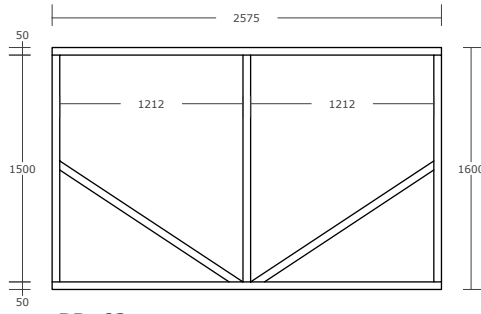

BB_62

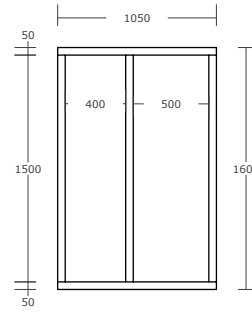

BB_63

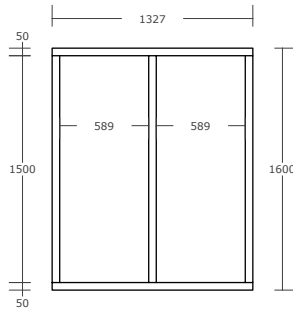

BB_64

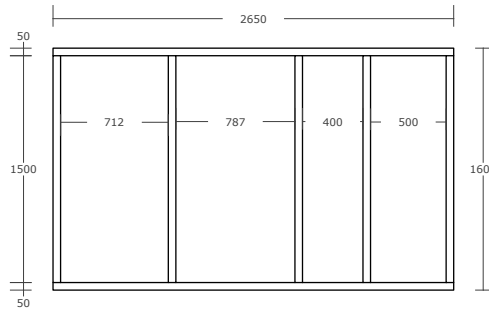

BB_65

Roof Panels

Timber 50x50mm

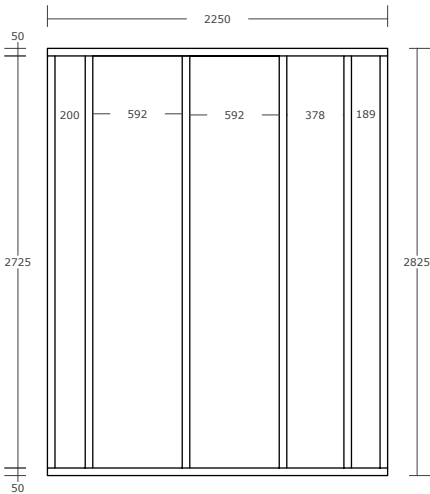

BB_71

Doors

Timber 50x50mm

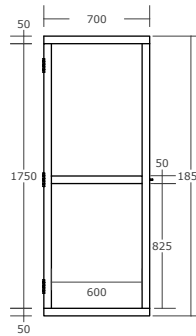

BB_72

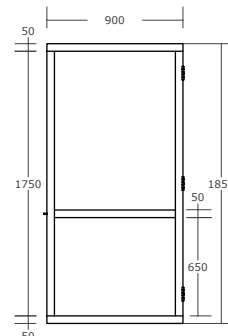

BB_73

Bathing Block

Details

Print to size A4

MARCH 2022

8.4 Bathing Block Step-by-Step Construction Sequence

Step 1:
PLATFORM

- To accommodate the structure and a surround clearance of 1m for construction, a total area of **5m x 7.5m** to be cleared and perfectly levelled.

- Clear area of **6m x 7.5m** if timber propping required. Refer to *Appendix B.1 Component Details*.

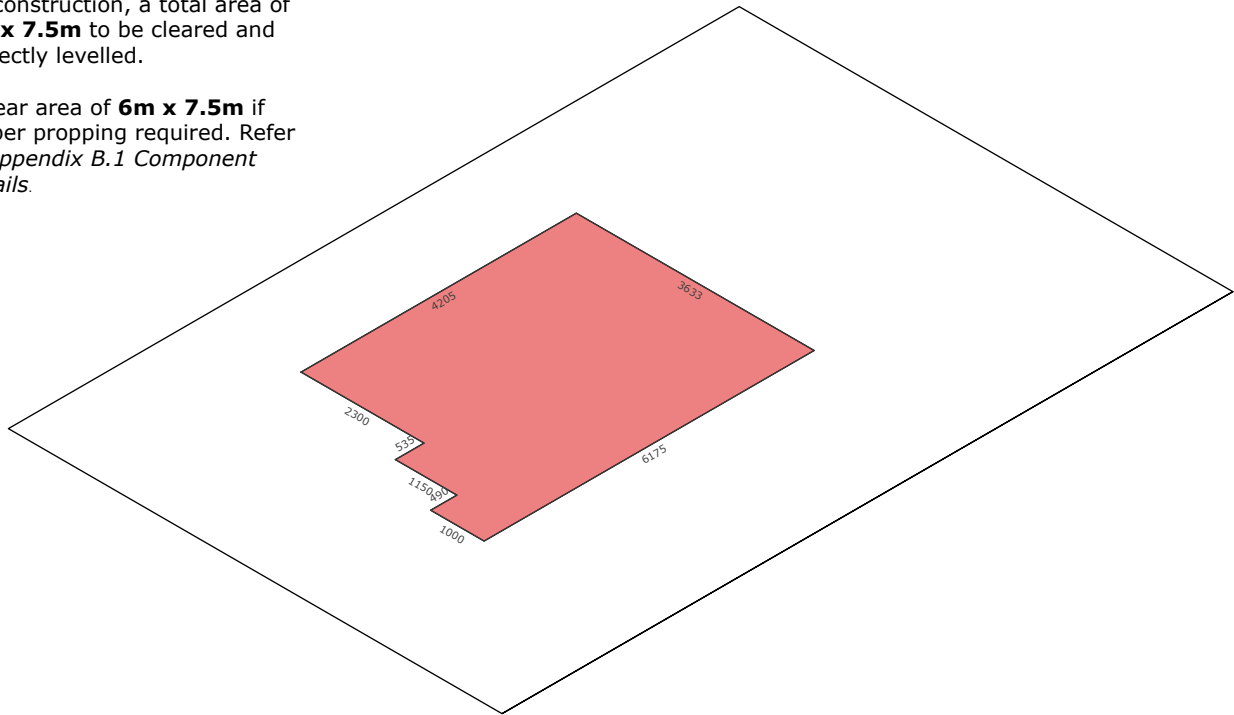

Step 2:
PLATFORM

- Arrange 2x **BB_01** panels along rear and 5x **BB_02** panels as shown bolting panels together at each end.

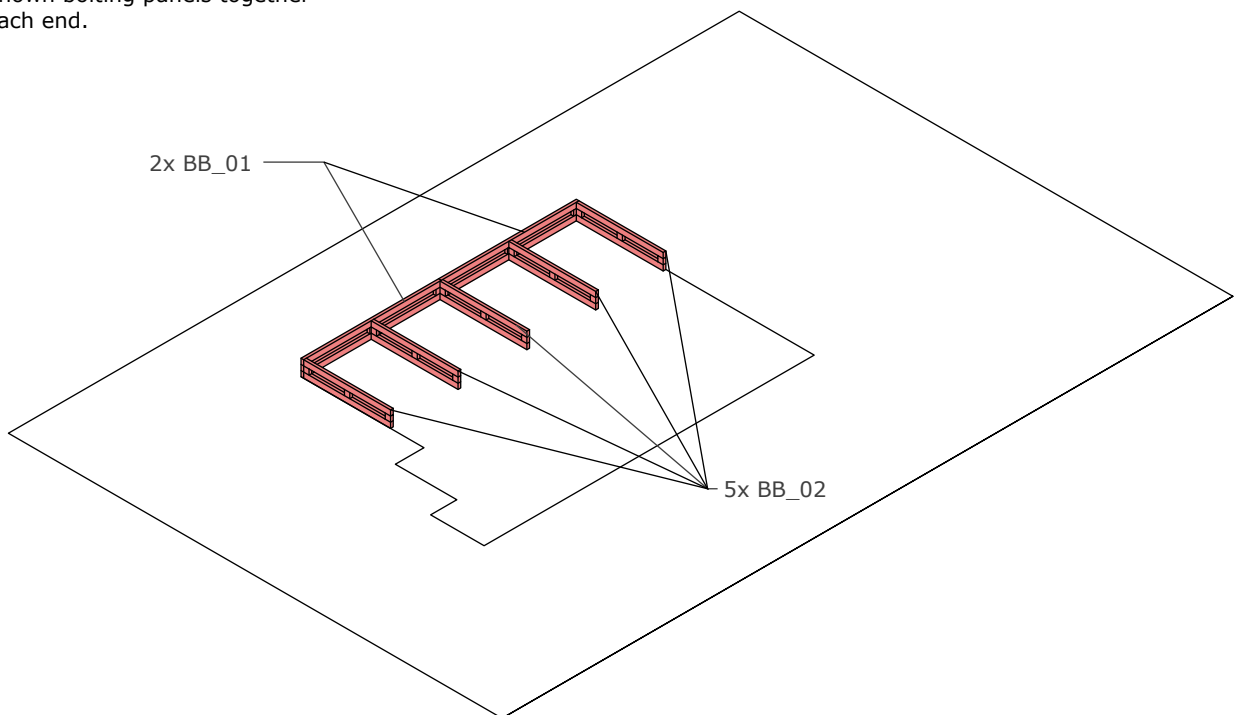

Step 3:
PLATFORM

- Bolt 2x further **BB_01** panels to front of panels.

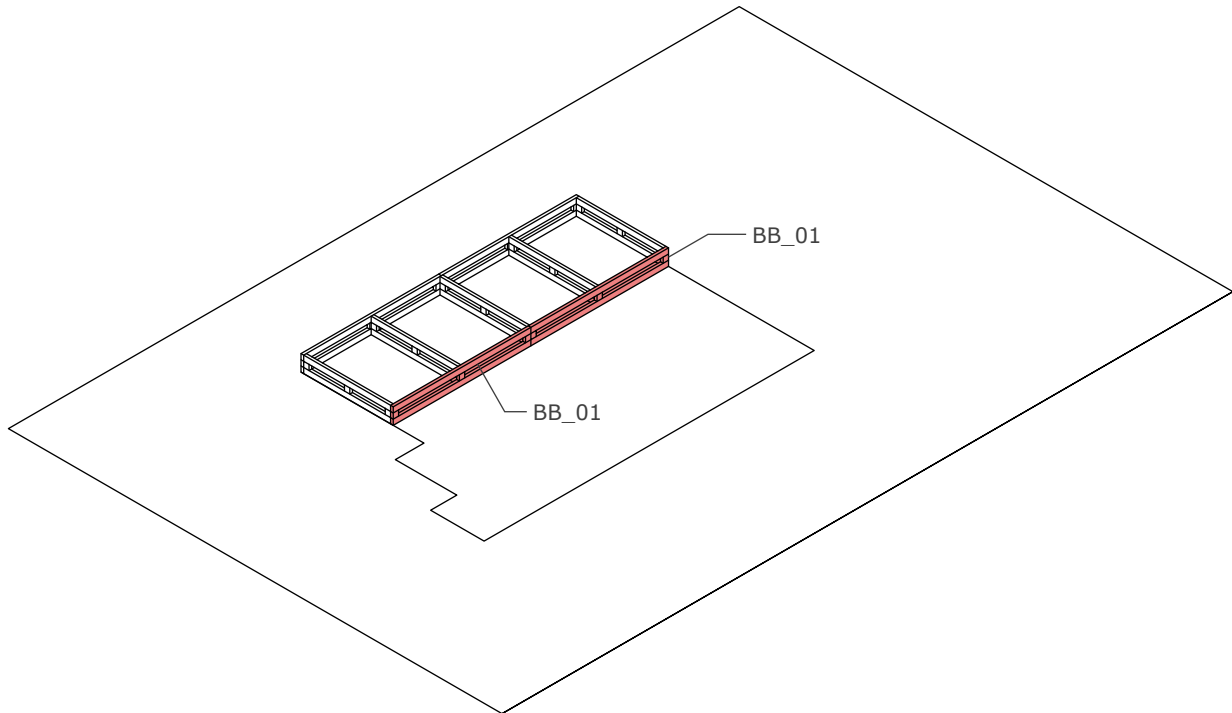
**Step 4:**
PLATFORM

- Repeat the same steps 2 and 3 for 3x **BB_01** panels, 5x **BB_02** panels and 3x **BB_03** panels with 8x **M10x22cm** and 14x **M10x17cm** bolts.

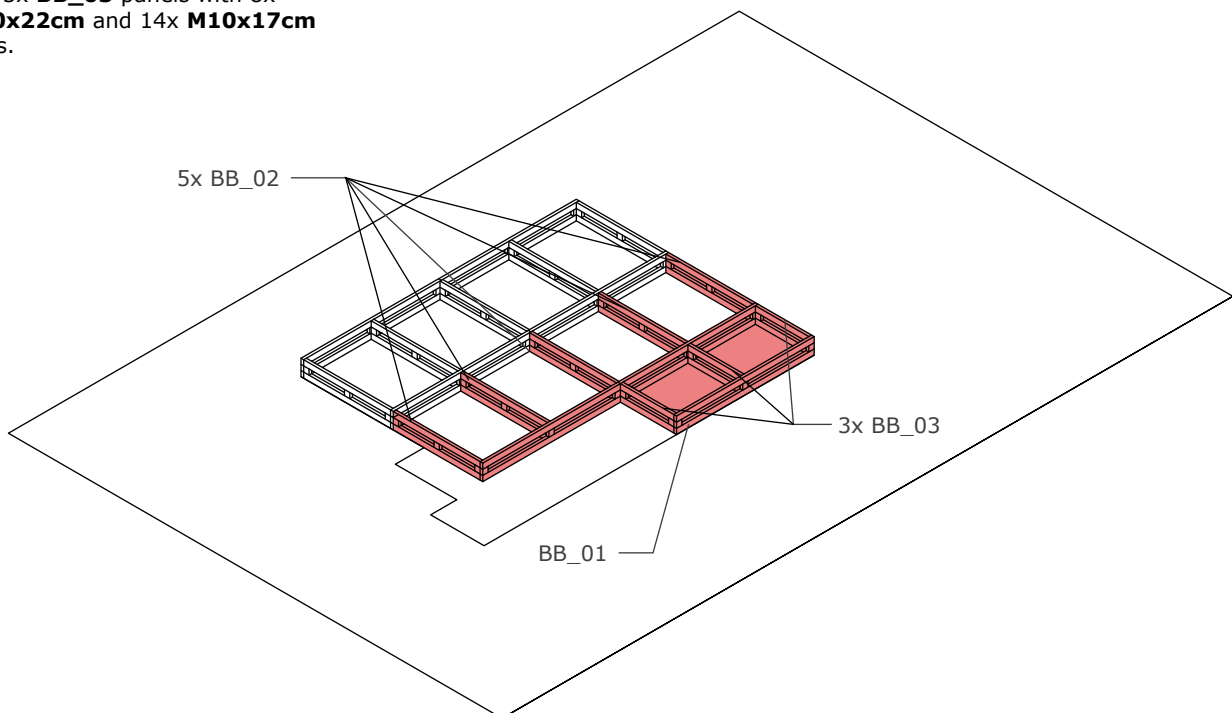

Step 5: PLATFORM

- Add 10x timber planks (8x **BB_P01**, 2x **BB_P02**) as referenced to complete raised platform and fix with wood screws.

- Layout and bolt 1x **BB_11** to the rest of the platform for the ramp.

- Install 2x **BB_P03** side planks for the stairs and screw in place.

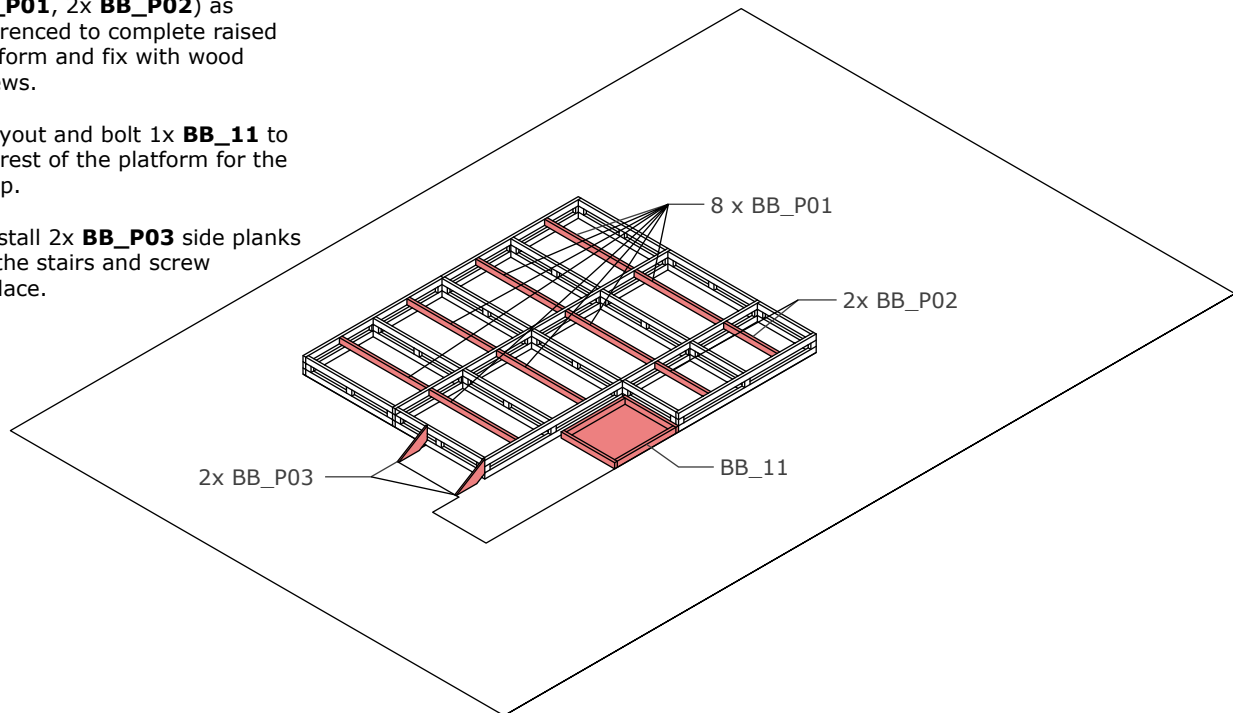

Step 6: RAMP

- Install panel **BB_12** on top of panel **BB_11** for the ramp and bolt in place.

- Install shower drainage pipework as shown. Refer to

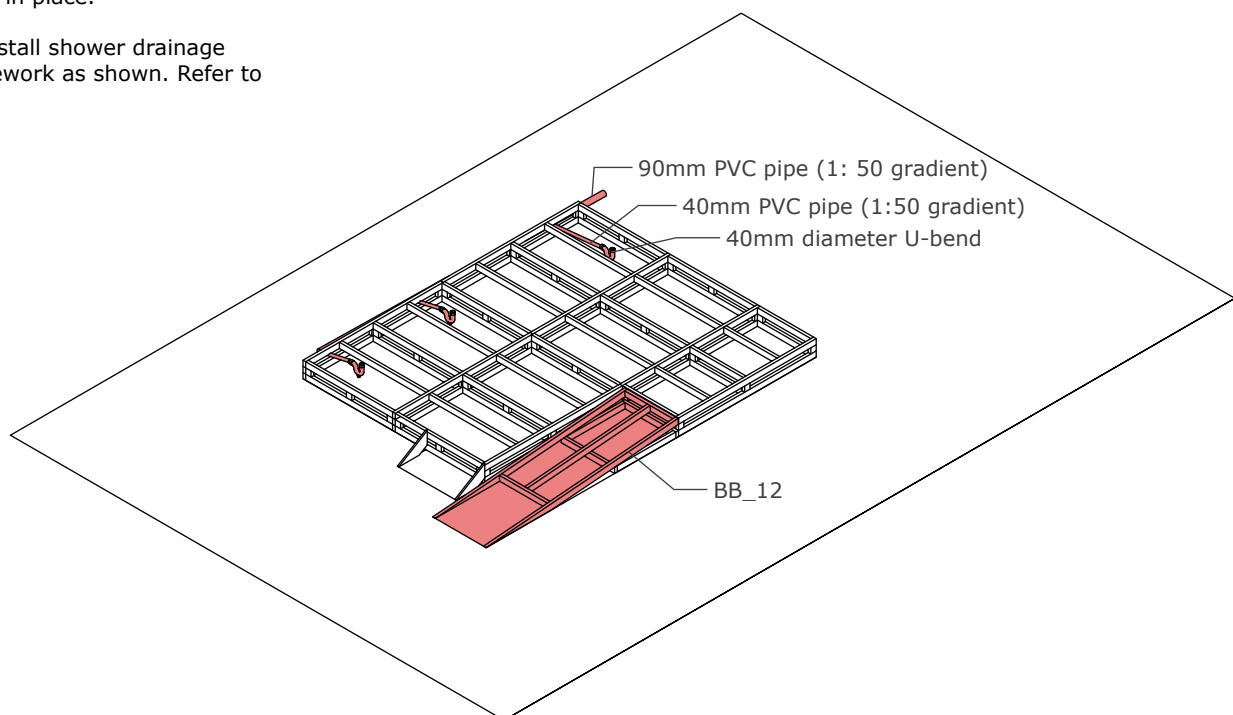

Bathing Block

Step by step

Print to size A4

MARCH 2022

Step 7: TIMBER DECKING

- Install **timber decking planks** across all of the ramp and the raised platform with nails leaving gaps for latrine holes.

- Install 1x **BB_P04** wooden plank for the stairs with wooden screws.

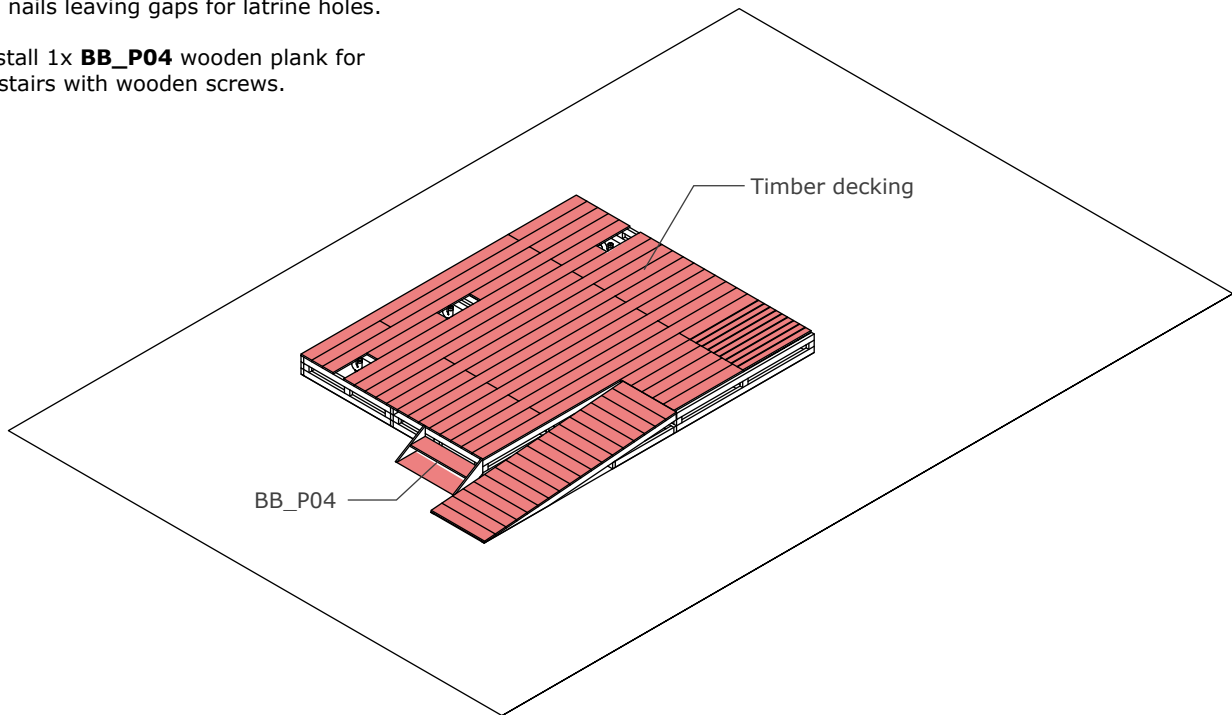

Step 8: LATRINE SLABS

- Place 3x **latrine slabs** in each location and bolt into place with fixing bolts provided.

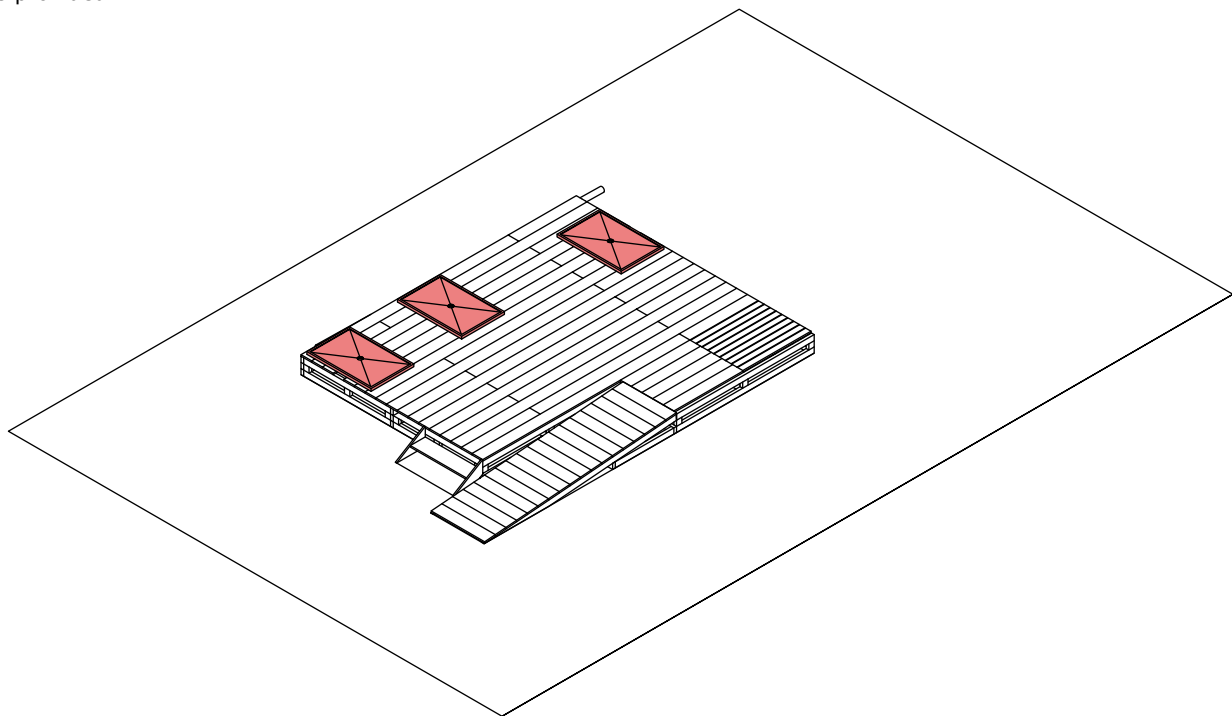

Step 9: CUBICLE PANELS

- Install **cubicle panels** (2x **BB_51**, 2x **BB_52**, 1x **BB_53**, 3x **BB_54** and 1x **BB_55**) as reference tags indicate starting at the rear of the platform and working forwards. Bolt panels together.

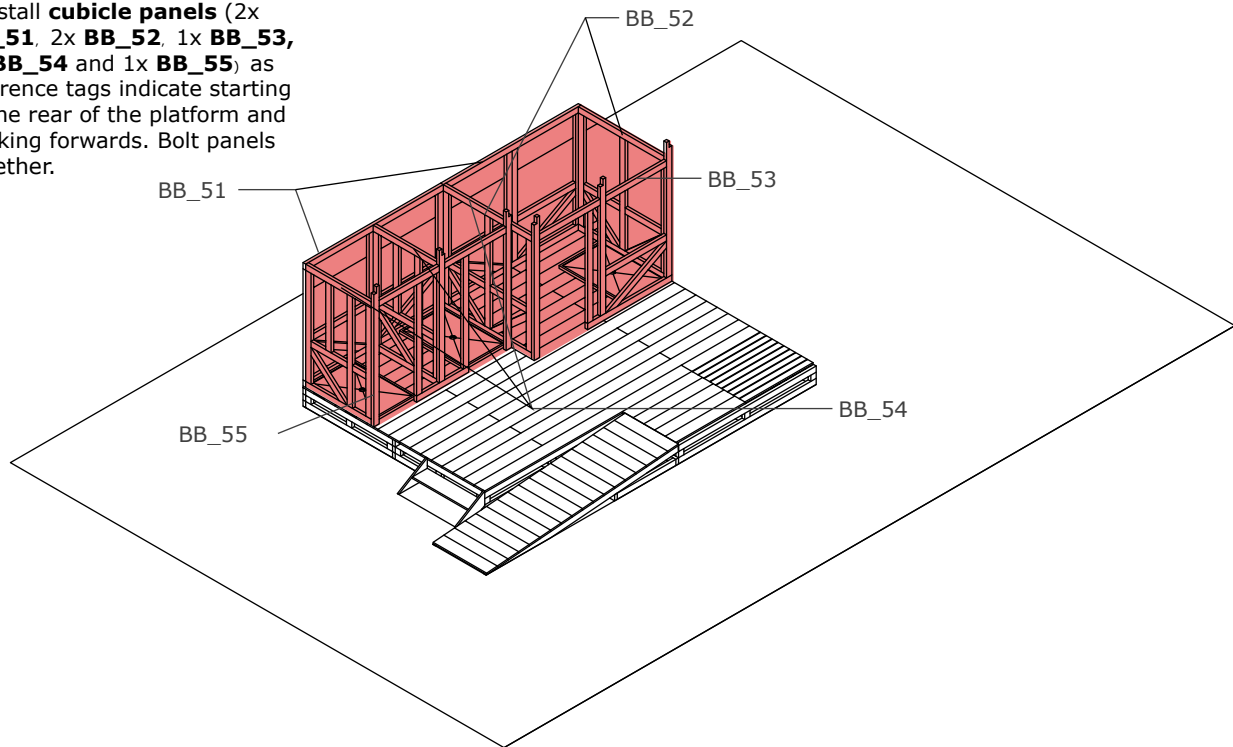

Step 10: SCREEN PANELS

- Install referenced **screen panels** (1x **BB_61**, 1x **BB_62**, 1x **BB_63**, 1x **BB_64** and 1x **BB_65**) around the perimeter of the raised platform as shown.

- Install planks 2x **BB_P05** to the back face of the Bathing Block and 1x **BB_P06** on the inside of the largest cubicle as shown and screw in place.

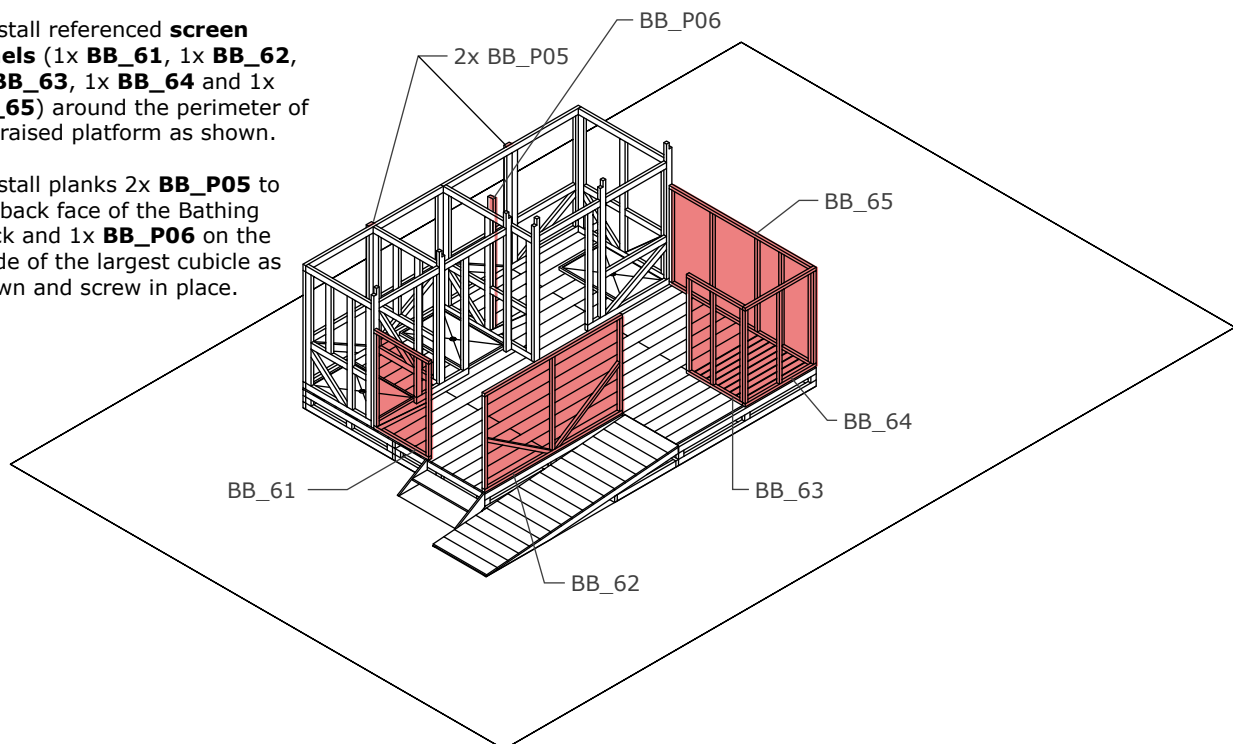

Bathing Block

Step by step

Print to size A4

MARCH 2022

Step 11: RAILINGS

- Install 10x vertical handrail posts as shown (1x **BB_P07**, 8x **BB_P08**) and screw in place.

- Install handrail (**BB_P09**) around perimeter of the ramp and the stairs at 600 and 900mm heights from walking surface.

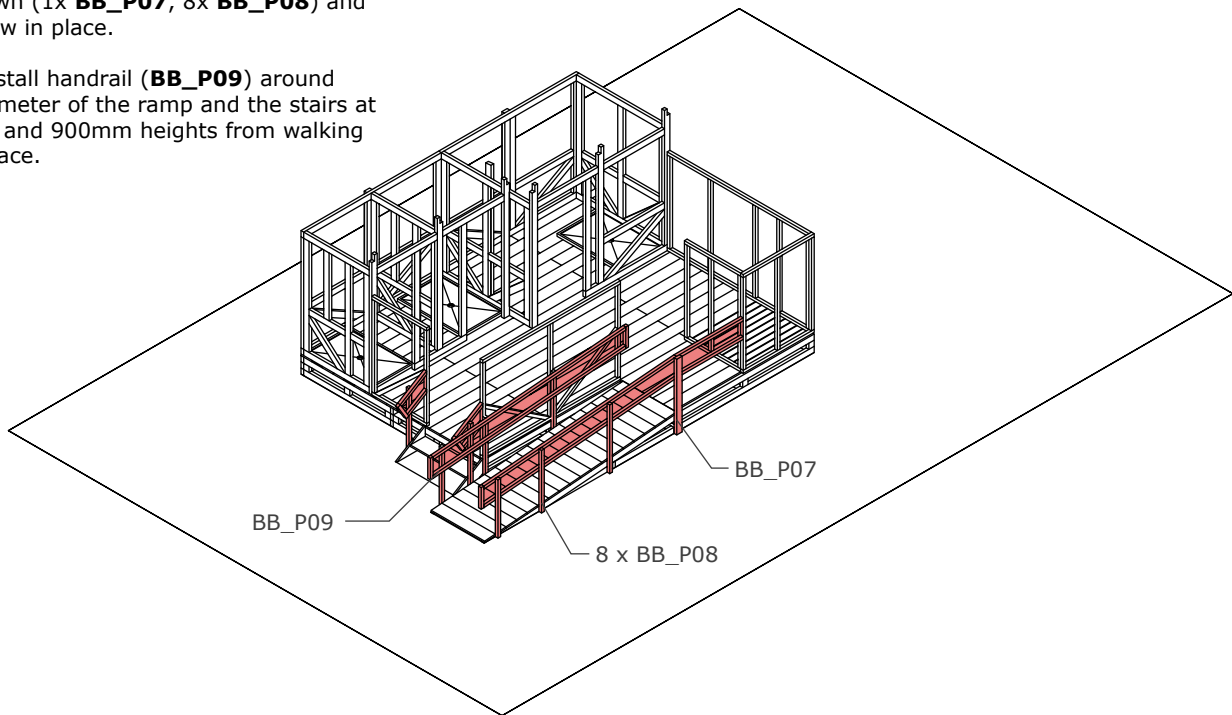

Step 12: ROOF

- Install 6x horizontal timber **BB_P10** roof supports on top of the cubicles and screw in place.

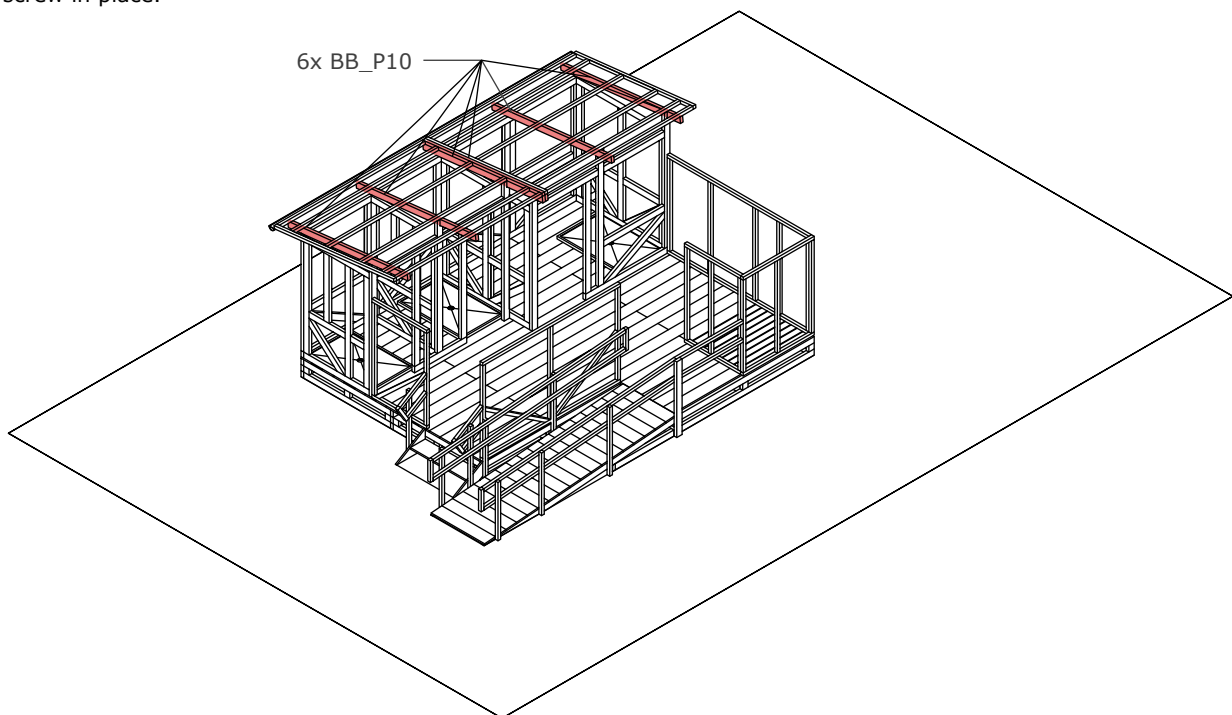

Step 13:
ROOF

- Install 2x **BB_71** roof panels to top of the cubicles bolting together.

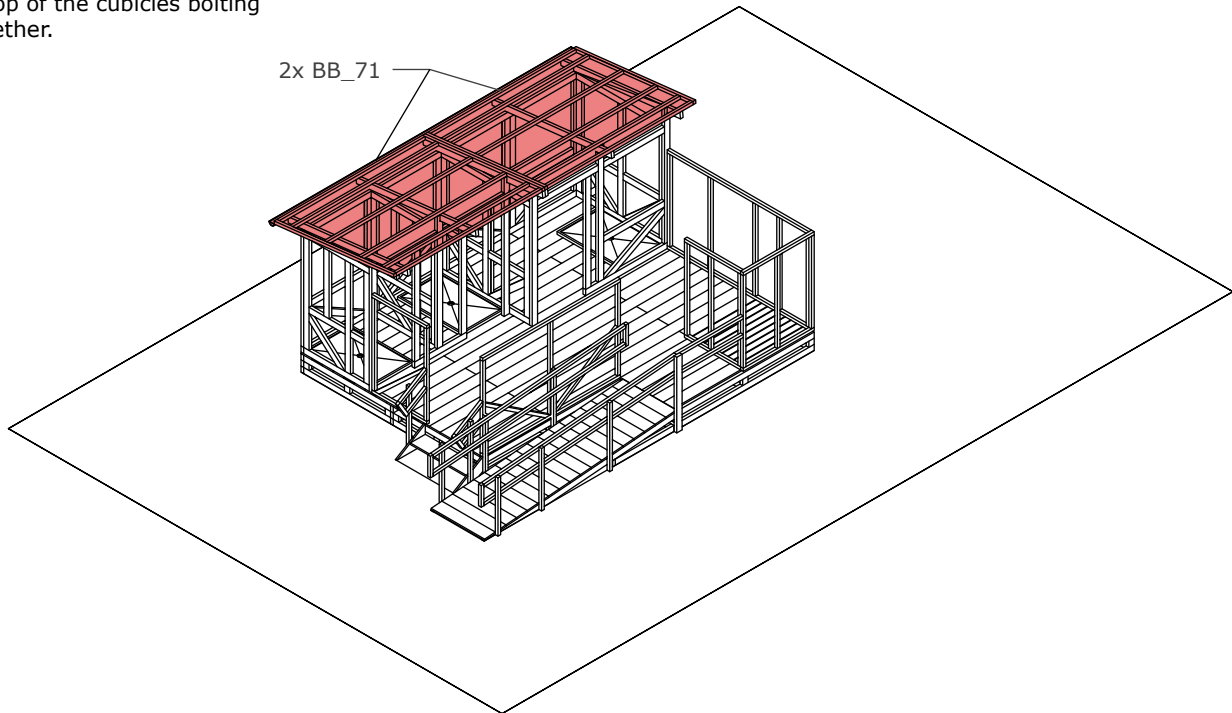
**Step 14:**
PLASTIC SHEETING

- Install cubicle doors x2 **BB_72** and 1x **BB_73**
- Install **plastic sheeting** with domed head nails around cubicles, screens and roof panels.
- Install equipment as detailed in cubicle plans.

